

**EM 61-MK2  
and  
EM61-MK2HP  
4 CHANNEL HIGH SENSITIVITY  
METAL DETECTORS  
OPERATING MANUAL**

**GEONICS LIMITED**

***LEADERS IN ELECTROMAGNETICS***

8-1745 Meyerside Drive, Mississauga, Ontario L5T 1C6

Tel: (905)670-9580 Fax: (905)670-9204

E-mail: [geonics@geonics.com](mailto:geonics@geonics.com) Web site: <http://www.geonics.com>

January 2006

**EM61-MK2  
and  
EM61-MK2HP  
4 CHANNEL HIGH SENSITIVITY METAL DETECTORS  
OPERATING MANUAL**

---

**TABLE OF CONTENTS**

**INTRODUCTION**

<b>A.</b>	<b>EM61-MK2 SYSTEM .....</b>	<b>A-1</b>
1.	System Assembly	2
2.	EM61-MK2 Console	3
3.	Notes on Multiple Gates Operation	4
4.	Hand-held Option EM61-HH-MK2	4
	4.1 Sensor Assembly - Wheel Option	4
	4.2 Sensor Assembly - Non Wheel Operation	5
5.	GPS Option	10
6.	Console Battery	10
	6.1 Console Battery Care	10
7.	Digital Recorder (Allegro) Batteries	11
	7.1 Main Power Source	12
	7.2 Short-term Backup Supply	23
	7.3 Backup Battery, Real Time Clock	24
8.	50 Hz/60 Hz Operation	24
9.	Technical Specifications	25
<b>A1.</b>	<b>EM61-MK2HP SYSTEM .....</b>	<b>27</b>
1.	Operating Notes	27
	1.1 Output Power Switch	27
	1.2 Two Battery Option	27
	1.3 Charging High Power Battery Pack	27
2.	Technical Specifications	30
<b>A2.</b>	<b>EM61-MK2 (MK1) CALIBRATION DEVICE (QC COIL) .....</b>	<b>31</b>
1.	Introduction	31
2.	Description	31
3.	Calibration Procedure	31
	3.a. External Device	31
	3.b. Internal Device	31
4.	Table I of the Standard Value	32
	4.1 EM61-MK2 with 1 x 0.5 m Coil	32
	4.2 EM61-MK2 with 1 x 1 m Coil	32
5.	External QC Coil Mounting	32
6.	EM61-MK2 Recalibration	34
	6.1 Gain Adjustment Procedure	34
<b>B.</b>	<b>EM61-MK2 DATA LOGGING SYSTEM .....</b>	<b>B-1</b>

1.	Introduction	1
	1.1 Program Requirements	2
	1.2 Installing EM61MK2	2
	1.3 Data Files Transfer	2
	1.4 Running EM61MK2 Program	3
	1.5 Main Menu	3
	Short description of Main Screen options	4
2.	Survey Setup	5
3.	Logger Setup	9
4.	Set Port for GPS	11
	4.1 Monitoring GPS Receiver Output	13
5.	Display Options	15
6.	Logging Data	17
	6.1 Monitoring Mode	17
	Description of Monitoring Mode options	19
	6.2 Stand By Mode	25
	6.3 Logging Mode	26
	6.4 Stand By Mode Field Options	27
7.	View Data Files	37
Appendix A		41
	A.1 Description of Data File in EM61MK2 Allegro CX Format	41
	A.2 Conversion Factors	44
	A.3 Example of File in EM61MK2 (Allegro CX) Format	46
Appendix B		47
	B.1 Using the EM61MK2 with a GPS Receiver	47
	B.2 Description of GGA and GSA Data Messages	48
<b>B2.</b>	<b>EM61-MK2xp DATA LOGGING SYSTEM .....</b>	<b>B2-1</b>
1.	Introduction	1
	1. Program Requirements	2
	2. Installing EM61-MK2xp	2
	3. Running EM61-MK2xp Program	2
	4. Main Screen	3
	Short description of Main Screen options	3
2.	Survey Setup	5
3.	Logger Setup	9
4.	Set Port for GPS & Monitoring	13
	4.1 GPS Port Setup	13
	4.2 Monitoring GPS Receiver Output	15
5.	Display Options	19
6.	Logging Data	21
	6.1 Monitoring Mode	21

	Description of Monitoring Mode Options	24
6.2	Stand By Mode	32
6.3	Logging Mode	34
6.4	Stand By Mode Field Options	36
Appendix A		45
A.1	Description of Data File in EM61-MK2xp Format	45
A.2	Conversion Factor	48
A.3	Example of File in EM61-MK2xp Format	50
Appendix B		51
B.1	Using the EM61-MK2xp with a GPS Receiver	51
B.2	Description of GGA and GSA Data Messages	52
<b>C.</b>	<b>SURVEY PROCEDURE .....</b>	<b>C-1</b>
1.	Survey Layout	1
2.	Survey Line Spacing	2
3.	Survey Station Spacing (Recording Interval)	2
4.	Control of Recording and Instrument Position	2
4.1	Odometer Mode	2
4.2	Auto Mode	3
4.3	Manual Mode	3
<b>D.</b>	<b>DATA PRESENTATION .....</b>	<b>D-3</b>
1.	Data Presented in the Profile Form	4
1.1	Comments Regarding the Presentation of Data in Profile Form	4
2.	Data Presented in the Contouring Form	4
2.1	Samples of Black and White Contour Maps	6
a.	Line Contour Map	
b.	Grey Filled Line Contour Map	
c.	Shaded Relief Contour Map	
2.2	Samples of Colour Contour Map	7
a.	Colour Filled Contour Map	
b.	Colour Filled Contours with Shaded Relief Map	
c.	Colour Shaded Relief Map	
2.3	Comments Regarding the Presentation of Data in Contouring Form	8
<b>E.</b>	<b>DATA INTERPRETATION .....</b>	<b>E-8</b>
1.	Separation of Shallow and Deeper Targets	8
2.	Calculation of Apparent Depth of Target	12
3.	Reduction of External Noise	13
<b>F.</b>	<b>RESPONSE FROM SOME STANDARD TARGETS .....</b>	<b>F-15</b>

1.	Pipe Response with Depth	17
1.1	Ferrous (Steel, Iron) Pipes	
1.2	Nonferrous Metallic (Aluminum, Copper) Pipes	
2.	Sphere Response with Depth	30
2.1	Ferrous (Steel, Iron) Spheres	
2.2	Nonferrous Metallic (Aluminum, Copper) Spheres	
3.	Response from 55 Gallon Steel Drum	36
4.	Detectability Depth vs Target Diameter	37
4.1	Steel Pipes	
4.2	Aluminum Pipes	
4.3	Steel Balls	
4.4	Aluminum Balls	

**G. OPERATIONAL PROCEDURES AND QUALITY CONTROL RECOMMENDATIONS-G-1**

A	INTRODUCTION	A-1
B	THEORY	B-1
C	PLANNING	C-3
C.1	Research Site History	C-3
C.2	Research Site Geology	C-3
C.3	Preparation of Geophysical Investigation Plan	C-3
D	AMPLITUDE RESPONSE AND DEPTH OF DETECTION	D-5
D.1	Introduction.	D-5
D.2	Geophysical Noise	D-7
D.3	Filtering Noise	D-8
E	EQUIPMENT FUNCTIONALITY AND QC TESTS	E-8
E.1	Out of Box Equipment Tests	E-9
E.2	Initial Geophysical Instrument Checks	E-10
E.3	Suggested Daily Instrument Checks	E-12
E.4	Examination of Repeat Data	E-12
F	DATA ACQUISITION	F-13
F.1	Survey Design Elements.	F-13
F.2	Operating Procedures for EM61 and EM61-MK2	F-15
G	NAVIGATION	G-19
G.1	Introduction	G-19
G.2	Conventional Navigation	G-19
G.3	Global Positioning System (GPS)	G-20
H	DATA STORAGE AND TRANSFER	I-23
H.1	Recommended Field Storage and Transfer Procedures	I-23
I	DATA PROCESSING AND ANALYSIS	I-23
I.1	Introduction	I-23
I.2	Field Editing Data	I-23
I.3	Preprocessing	I-24
I.4	Processing and Target Selection	I-25
I.5	Advanced Processing	I-27

**TABLE OF FIGURES**

Figure B.1	Time Domain Theory	B-1
------------	--------------------	-----

Figure D.2	Fort Ord Detection Depths -EM61	D-7
Figure E.1	Example Test Site	E-11
Figure F.1	Instrument Warm Up	F-16
Figure I.1	Example of Chevron Affect	I-25

#### TABLE OF TABLES

Table D.1	Detection Depths	D-6
Table E.1	Instrument Test Table	E-13
Table F.1	Line Spacing Recommendations	F-13
Table F.2	Station Spacing Recommendations	F-14

#### TABLE OF EQUATIONS

Equation I.1	Geonics Depth Calculation for 1 x 1 meter system	I-28
Equation I.2	Geonics Depth Calculation for 1 x 0.5 meter system	I-28

# EM61-MK2 HIGH SENSITIVITY METAL DETECTOR OPERATING INSTRUCTIONS

---

## INTRODUCTION

The **Geonics** EM61-MK2 is a high sensitivity high resolution 4 channel time-domain metal detector which is used to detect both ferrous and non-ferrous metallic objects. It consists of a powerful transmitter that generates a pulsed primary magnetic field, which induces eddy currents in nearby metallic objects. The decay of these currents is measured by two receiver coils mounted on the coil assembly. The responses are recorded and displayed by an integrated computer based digital data logger with real time numerical and graphic display. Two ports on the logger allows simultaneous collection of EM and GPS data. For further processing and interpretation data can be transferred to the PC type of computer.

The EM61-MK2 detects a single 200 litre (55 gallon) drum at a depth of over 3 meters beneath the instrument, yet it is relatively insensitive to interference from nearby surface metal such as fences, buildings, cars, etc. By making the measurement at a relatively long time after termination of the primary pulse, the response is practically independent of the electrical conductivity of the ground.

Due to its unique coil arrangements, the response curve is a single well defined positive peak, greatly facilitating quick and accurate location of the target, the depth of which can usually be estimated from the width of the response and/or from relative response from each of the two receiver coils.

A single operator can carry the EM61-MK2 antenna system from a belt harness, in which case the data logger is usually set to record the data at fixed increments of time (with the facility to add fiducial records when passing by known locations). Alternatively, the operator can pull the system on an optional trailer, in which case an odometer mounted on the axle of the trailer wheel automatically triggers the data logger to record the measurements.

An optional set of small sensors provides for a hand-held operation of the system, for high mobility and increased sensitivity to small near surface objects.

Integrated control switch allows for synchronous operation of multiple units if desired.

With its comprehensive detection, depth of investigation and speed of surveying, the EM61-MK2 is an ideal metal-detector. The ease and certainty with which survey results can be interpreted make the EM61-MK2 practical for both the occasional user and expert geophysicist.

## A. EM61-MK2 SYSTEM

## 1. System Assembly

The EM61-MK2 consists of three major parts: coil assembly, backpack with battery and processing electronics console and digital data recorder.

Figure 1 shows the system assembled for the trailer mode of operation.

To assemble the trailer set the bottom coil (larger of the two) on the ground with the top of the coil facing the ground and slide the wheel assembly into the wheel guide on the side of the coil so that the wheels are outside the coil frame. Make sure that the wheel assembly with the short cable (1) is placed on the right side of the coil as indicated on the Figure 1. Secure the wheels with the latch. Rotate the coil so that the main coil frame is resting on the wheels. Set the four stand off bars to each corner of the bottom coil and lock it with wing nuts.

Assemble the second (smaller) coil frame as indicated on the Figure 1, and lock it to the coil stand off.

a) For instrument with the boom: attach the coil section of the boom to the main coil by aligning the self-locking key with the socket. Turn the conical knob on the end of the boom anti-clockwise so that the expansion ring collapses. Push the end of the boom through the socket and turn the knob clockwise so that the expansion ring expands and locks. To complete the assembly of the boom push the top portion of the boom (section with logger holder) into the coil section of the boom, and lock it by the clockwise rotation of the black lock nut located on the coil section of the boom. Make sure that the 4 pin lock ring is aligned so that when two sections of the boom are locked, the logger holder is facing up. Slide the logger (*PRO4000* field computer) in to the logger holder and secure it by the thumb screw located under the holder.

b) For instrument with the handle (Figure 1-A-1) set the handle (s) into the handle bracket located on the bottom coil and lock it with the attached locking pin on each side. Set the logger into the logger holder. Use appropriate hole (one of four) on the holder to obtain desired logger viewing angle. Secure the logger with the thumb screw.

Connect the wheel cable to the odometer connector on the bottom coil frame. Interconnect the bottom and top coils with the coil interconnection cable (2) cable. An optional carrying net, suspended across the top coil could be used to carry the console cables and spare battery to and from the survey site.

Set the fresh (recharged) battery into the backpack and interconnect the "REC" connector on the electronic console with the logger using logger cable (3), and connect the "COIL" connector on the console to the coil connector box located on the bottom coil using coil cable (4), as indicated on Figure 1. Place the backpack on your back and adjust the length of the straps to the most comfortable position. Connect end of the boom to the console harness for free hands operation of data logger

For a survey that does not allow a passage of 1 m width of coil assembly, set can be assembled as shown in Figure 1-B or Figure 1-B-1. For the "narrow" operation with the handle, remove handle brackets from wider side of bottom coil and set it close to the narrow side, as per Figure 1-B-1.

For an option of operation without the wheels, in case that the wheels are not available or the terrain does not permit use of wheels, use the coil assembly carrying belt with four nylon



straps and attach it to the main coil frame as shown in Figure 1-C. The strap should be adjusted so that the main coil is about 40 cm from the surface of the ground when it is being carried.

Since the EM61-MK2 is extremely sensitive even to the very small metallic objects, make sure that you do not carry any metal objects like rings, watches, knives, keys, etc., while operating the system in the **harness** mode. During the operation the logger should not be closer than 25 cm (10") from the coil assembly, otherwise the noise will be introduced.

The backpack console could be carried by the same person that carries the coil assembly, or alternatively by a second person in front of, or behind the person carrying the coil assembly. To eliminate introduction of noise, make sure that the backpack is separated at least 15 cm (6") from the coil assembly.

## 2. EM61-MK2 Console

The EM61-MK2 backpack houses electronics console with the processing electronics, and the battery pack.

The connector (bottom) side of the console front panel houses three connectors and the Master (M) / Slave (S) operation control switch. The "COIL" connector (8 sockets) provides a port for the signal from receivers and transmitter coils. The "REC" connector (10 pins) provides for interface between electronic console and the control computer (logger). The "SYNC" port in connection with the "M/S" switch provides an option for synchronous operation of two or more EM61-MK2 units. For the single unit operation, the switch should be set to (M) position. For the operation of multiple units, one (control) unit should be set to the "M" position and all other units to the "S" position. A special (optional) cable is used to interconnect all console for simultaneous operation.

The logger controls the operation of the whole system and is used as a digital data recorder. The operation of the logger is described in section B of this manual. Note that for the proper operation of the instrument, as well as the recorder, it is necessary to interconnect console with the logger by the supplied cable (3).

The small LED lamp on the topside of the console indicates if the system is turned on under control of the logger. A small speaker with its associated volume control and output for external earphone, located near the power lamp, is used as an audio monitor of the response. The push-pull circuit breaker next to the audio control is the main fuse for protecting the electronic from overload, in case of instrument malfunction. For the proper operation of the system the circuit breaker button has to be pushed in.

The mode switch on the panel allows operation of the instrument in the four channel (4) mode or in the differential (D) mode. In the four channel mode, the instrument records four time channels measured by the bottom receiver coil, while in the D mode three channels are recorded from the bottom coil and one channel from the top receiver coil. D mode provides for operation in the differential mode that is used later during processing for target depth calculation and suppression of near surface response. See Section B of this manual, for more detail about the differential mode of the operation.

**Note that regardless of the mode of operation; four channel mode (4) or differential mode (D), the top coil has to be connected to the coil connector box.** Also, note that when instrument operation is in D mode that the T channel of EM61-MK2 is equivalent to

the T channel of EM61 (EM61-MK2 predecessor). In either mode of operation "D" or "4", the channel 3 of EM61-MK2 is equivalent to the B channel of EM61.

### 3. Notes on Multiple Gates Operation

Original models of EM61 have only one channel where the response is sampled at one point on the decay curve. In order to increase the capabilities of the system, the latest model (MK2) has four channels, where the response is sampled and recorded at four time positions along the decay curve.

The multiple gates allow discrimination of the targets based on the different response decay rate, that depends on the target size, shape, material and orientation. The early channel detects targets with short and long decay rates from small, medium and large targets, while the late channel detects targets with the longer time constant (larger targets) only. The apparent time constant channel, proportional to the ratio between the early and the late gate signal, that is automatically calculated during the processing, allows classification of the targets with the same or similar characteristics.

### 4. Hand-held Option - EM61-HH-MK2

The EM61-HH-MK2 is the hand-held mode option for the EM61-MK2 High Sensitivity Metal Detector. In this mode of operation the standard sensor set is replaced with a small set of coils. The sensors can be used either with or without wheels. In the operation without wheels the wand with the sensors is used in a sweeping mode in front of the operator. In the case of the wheel operation mode, the wand with the sensors is set into the wheel assembly that allows a more controlled inline operation.

In the case of the wheel operation the recording is initiated by the wheel odometer mounted inside the wheel assembly, or by setting the automatic time-based mode of operation. The second option, automatic, is the normal mode of operation for the recording in the non-wheel mode. The rest of the operation of the system is the same as for the standard unit. Note that the registration of targets can be either by audio mode, permanent record mode or both modes simultaneously.

#### 4.1 Sensors Assembly - Wheel Option - Figure 2A(B)

To assemble the unit slide end of the sensor into slot **S** on the wheel assembly, align the block on the main tube with the socket on the wheel assembly and close latch L. Connect the coil cable (4A) to the coil connector on the main console.

The models that are supplied with the wheel mode, have the option of selecting 10 cm or 20 cm sampling intervals. The 20 cm recording interval is the same as on the standard EM61 unit (wheel mode), where the 10 cm sampling interval complements the higher resolution of the small sensors size of the hand-held unit. To select 10 cm or 20 cm sampling rate set the rate switch on the wheel assembly to either 01 or 02 position respectively, see Figure 2B. Note that if the 10 cm rate was selected, the

maximum surveying speed should not exceed 1 m/S , that is ½ of the maximum speed with the standard EM61-MK2 in the trailer mode.

#### 4.2 Sensor Assembly - Non Wheel Operation - Figure 2C

For the non-wheel operation use the provided harness to carry the sensor assembly.

Set the boom stabilizing handle into the logger holder and lock it with the provided thumb screw.

As per Figure 2C, set the pivot bar into the backpack and adjust the strap lengths to the most comfortable configuration. Connect the coil cable to the console coil connector.

The optimum operational height of sensors is 15 to 20 cm (6" to 8") from the surface of the ground.

Continue with the operation as with the standard set of sensors.

FIG 1-B

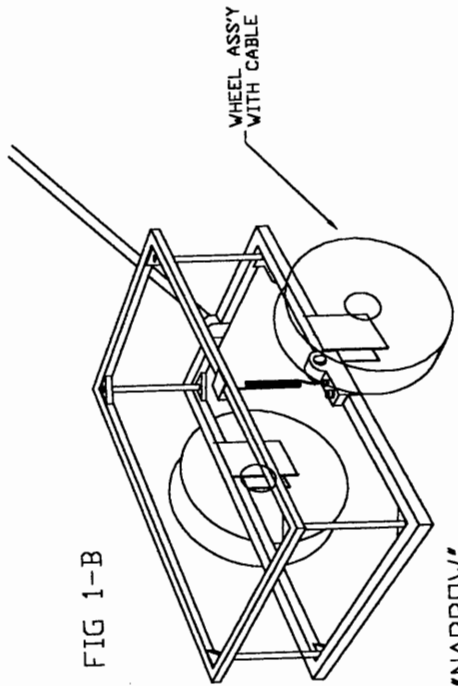

TRAILER ASS'Y

"WIDE"

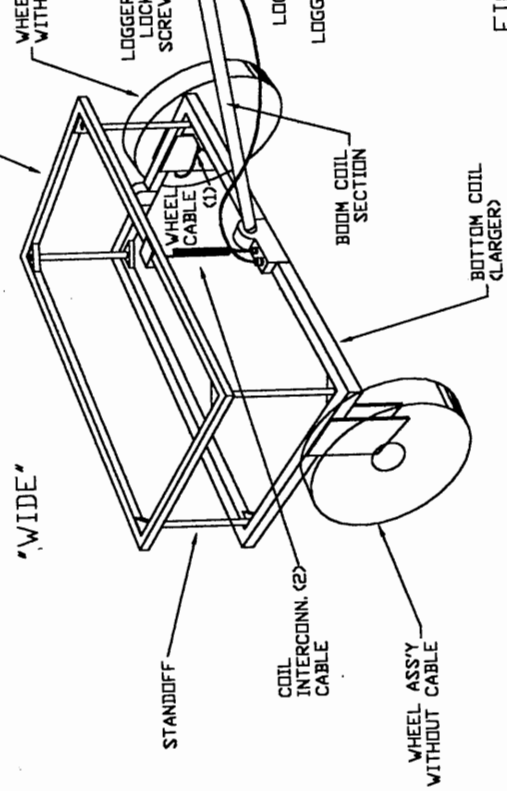

BACK PACK ASS'Y

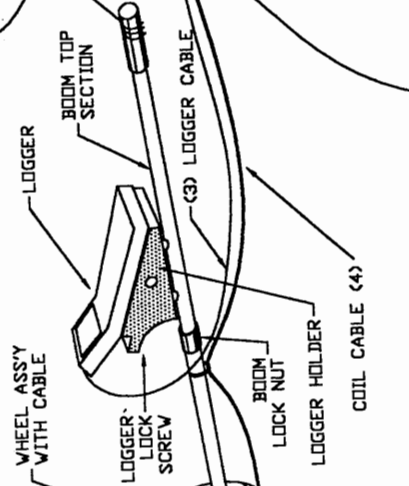
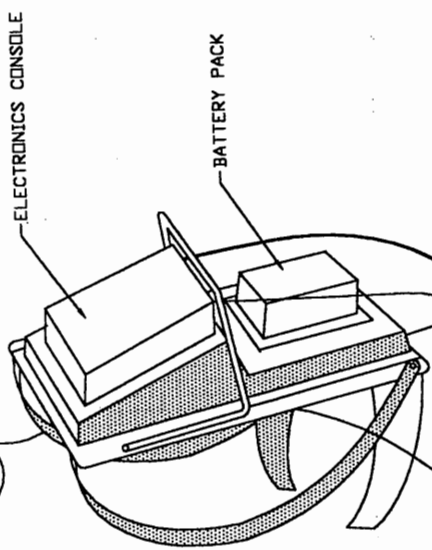

FIG 1-A

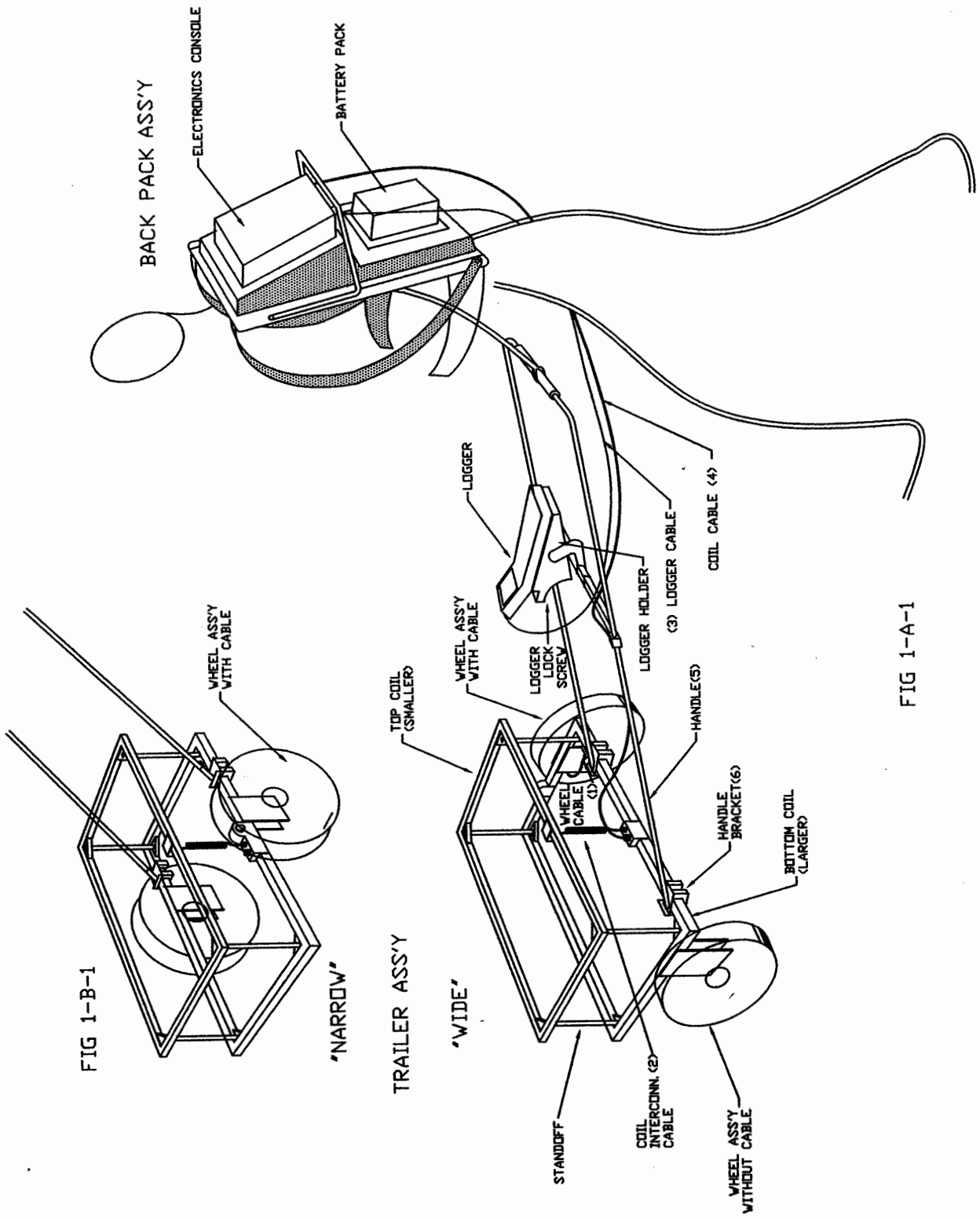

FIG 1-B-1

'NARROW'

TRAILER ASS'Y

'WIDE'

FIG 1-A-1

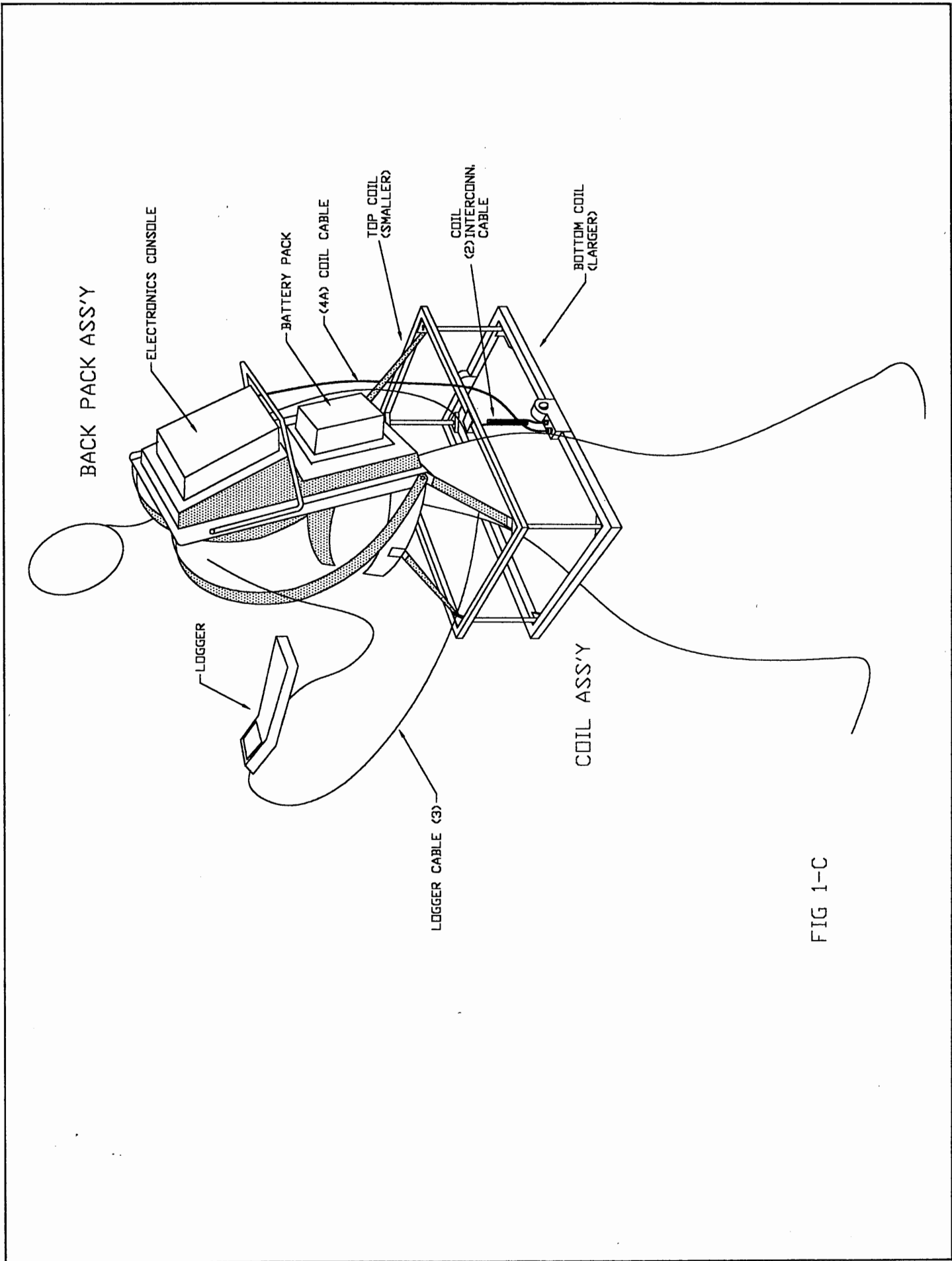

FIG 1-C

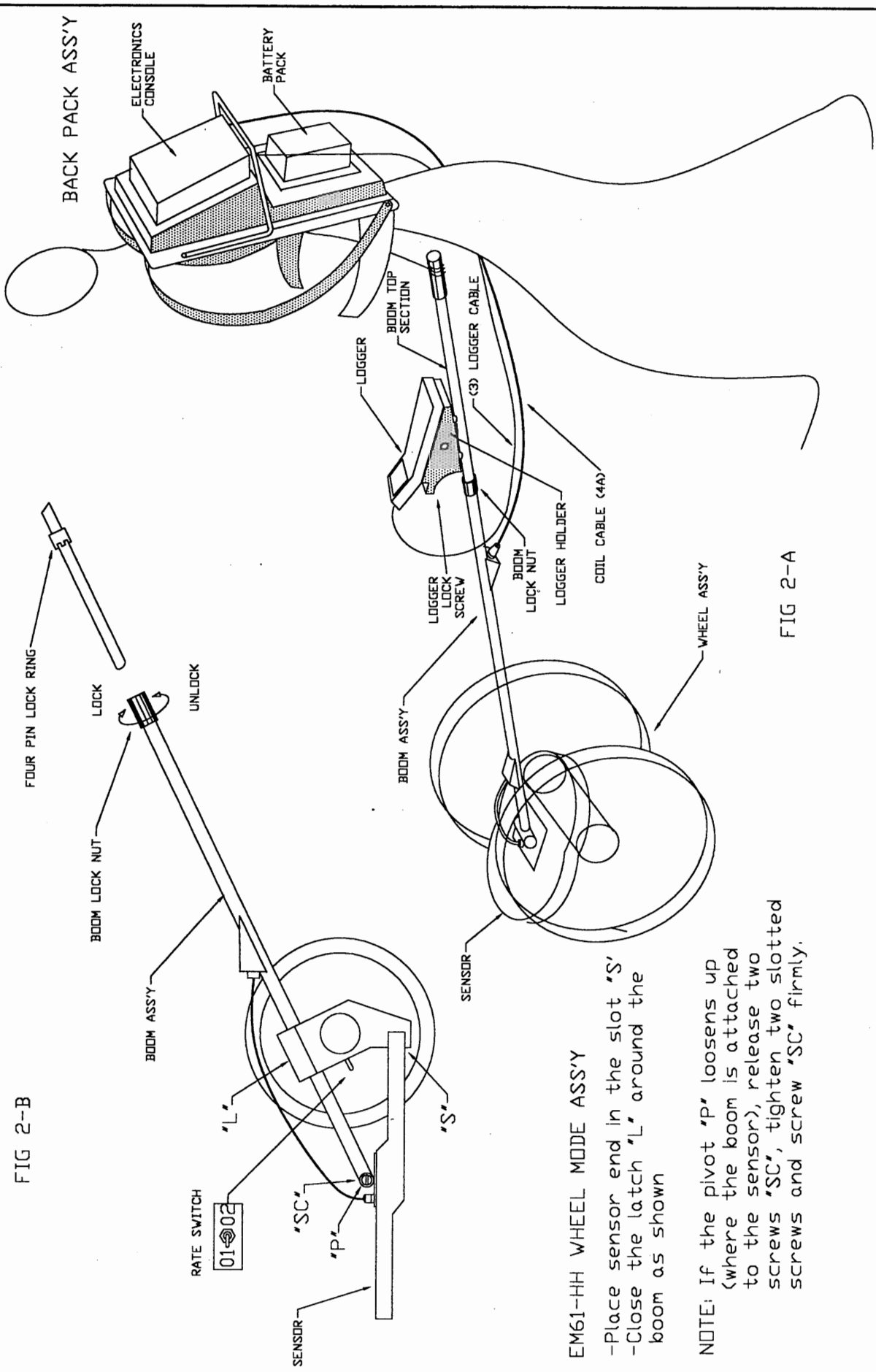

FIG 2-B

FIG 2-A

EM61-HH WHEEL MODE ASS'Y

- Place sensor end in the slot 'S'
- Close the latch 'L' around the boom as shown

NOTE: If the pivot 'P' loosens up (where the boom is attached to the sensor), release two screws 'SC', tighten two slotted screws and screw 'SC' firmly.

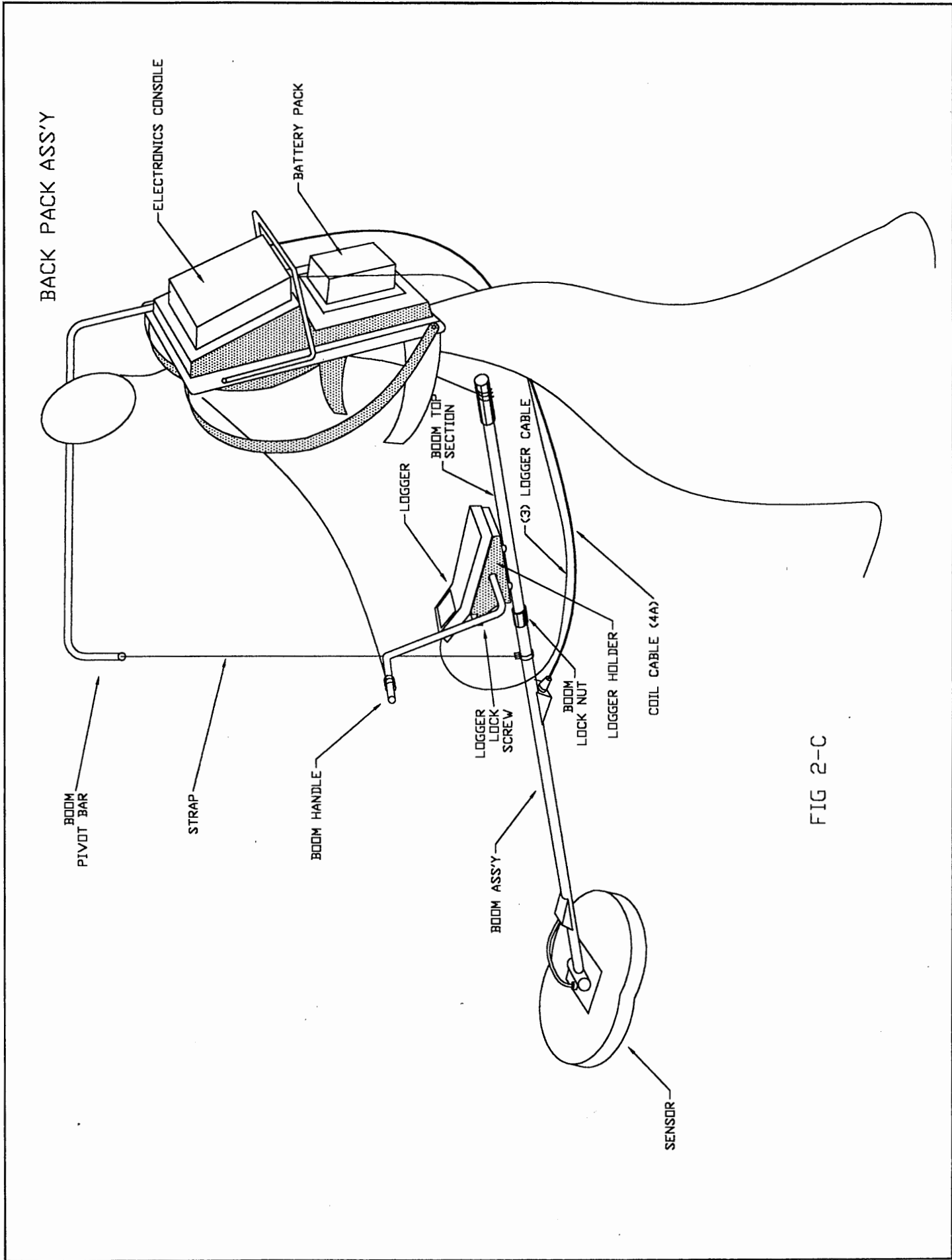

FIG 2-C



## 5 GPS Option

The EM61-MK2 system is designed for a direct interface with the GPS receiver. The EM61-MK2 controller (*Allegra*) with two serial ports and associated software allows direct interface to most of the standard format GPS receivers.

During the acquisition one port is receiving EM61 data, while the second port is simultaneously monitoring and recording data from the GPS receiver. Combined data set is stored in the same file inside the logger in the real-time.

Sections C and D of this manual give more detail on the GPS/EM61-MK2 operation. Note that an optional GPS Tripod that can be attached to the EM61-MK2 coil assembly is available from Geonics.

## 6. Console Battery

The instrument is supplied with two sets of rechargeable batteries. Each fully charged battery will last for about four hours of continuous operation. The battery pack is fixed to the backpack by three thumb screws and it is automatically connected to the console battery connector when it is placed in the appropriate place on the backpack. To check the battery voltage, interconnect console with the logger and go to **BATTERY CHECK** mode as described in the B section of this manual.

To determine if the battery will require charging or replacing soon, the battery voltage can also be measured with an external voltmeter. An advantage of using an external voltmeter is that the battery need not be installed in the system to obtain a voltage measurement.

If you are measuring the battery voltage with a voltmeter, you must insert the voltmeter probes correctly into the 3-socket connector on the battery pack front panel. If you inspect the connector closely you will notice that each socket is labelled with a letter. Insert the negative probe into the socket labelled A and the positive probe into the socket labelled C. (The A socket is also the system ground). Five ohms power resistor (- 25W) across battery, will ensure that it is loaded with approximately the same load as the EM61-MK2 transmitter. This will give a more accurate measurement of the condition of the battery.

The fully charged battery will read above 13 V. Recharge the battery if its voltage is below 10.5 V.

The battery can be charged by attaching the battery charger to the connector on the battery cover. Remember to connect the charger to the battery before applying power to the charger. Completely charging a fully discharged battery takes 14 hours. To prevent defective charger from damaging power supply PCB, do not charge battery, when battery is connected to the EM61-MK2 console.

### 6.1 Console Battery Care

The console is powered by Pb/gel type of batteries. Pb/gel batteries work on the same

principle as Pb/acid batteries. Gel is used in the place of acid, and the batteries are sealed. As a result they can be shipped by parcel post as well as by passenger and cargo aircraft (cf. IATA Restricted Cargo Regulations, Article 1924).

The Pd/gel batteries can be fully recharged from total discharge several hundred times. If you typically use only a fraction of the battery capacity before recharging, the number of possible recharges increases.

The batteries maintain full capacity regardless of the pattern of use, but their capacity will eventually decrease with age.

From full charge, the batteries will lose 2 to 3% of their charge per month when stored at 20°C.

### **Deep Discharge Protection**

The Dryfit battery, unlike conventional lead storage batteries, is protected against excessive discharge. In the event that a battery remains connected to a load for an excessive period of time, deep discharge protection ensures that the battery can be recharged without permanent damage. After 30 days of deep discharge, batteries should be recharged for a period of 48 hours. A completely discharged battery should not be left for longer than 30 days without recharging.

After recharge, it can be expected that the batteries will exhibit a loss in charge capacity, although this loss should not exceed 25% of original capacity. To recover lost capacity, batteries should be run through a series of (at least three) cycles of discharge and recharge.

### **Storage Conditions**

It is important that the battery is stored fully charged. After use, set battery on charge and keep it on till next use. If not possible to keep battery continuously on charge, it should be stored fully charged at a mean ambient temperature of +20°C and be recharged after a maximum of 6 months. At higher temperatures, the period will be shorter, and at lower temperatures, will be extended. Since the specific gravity of the electrolyte will fall as the state of charge is reduced, causing the freezing point to rise, only full charged batteries should be stored at extremely low temperatures. Given that storage in the fully charged state has essentially positive effects on life and cycle resistance, it is recommended that self discharge should not be allowed to fall to below 50% of the charged state.

Batteries should be stored in a dry place.

#### 7. Digital Recorder (Allegro) Batteries

The power consumption of the Allegro is very efficient. The Auto Suspend and Power Management features help to conserve power. Maintaining the battery pack and backup supply is simple.

There are three types of batteries and a backup capacitor associated with the Allegro:

- NiMH battery pack

- ' Battery holder for three alkaline cells (optional accessory)
- ' Internal lithium backup battery (powers the real-time clock and CMOS RAM)
- ' Super capacitor that serves as the RAM backup (maintains the RAM while you change the battery pack)



*The battery pack is inserted at the factory. Do not remove it initially.*

## 7.1 Main Power Source

The Allegro is powered by a rechargeable nickel metal hydride (NiMH) battery pack. The battery compartment is accessed through a door in the back of the case. **When you receive the Allegro, please note the following information about the batteries:**

- A NiMH battery pack is inserted into the Allegro before shipping. Immediately upon receipt of the Allegro, we recommend that you charge the battery pack for five hours using the AC power adapter. There is no reason to remove the battery pack prior to charging it.

By initially charging the batteries this way, you are able to become familiar with the Allegro's battery gauging feature and how the battery status LEDs work. This recommendation is made even if you eventually plan to use an external battery charger to charge the battery pack or if you are going to use the optional alkaline battery holder.

Prior to shipping the Allegro to you, the battery gauging is set, allowing the Allegro to know the pack's charge status. If you remove the battery pack and replace it, the charge status is unknown to the Allegro. Any time you insert a NiMH battery pack into the Allegro and then turn it on, a battery pop-up box asks you to enter the battery charge percent and capacity. These values must be set correctly for the battery gauging to work properly. Refer to *New Battery Pop-up Window* later in this section for details.

- 1) You can run the Allegro while it is charging.
- 2) Batteries should be charged at room temperature.
- 3) The NiMH battery pack must go through about three charge/discharge cycles before it can be charged to full capacity.
- 4) If you are using the optional alkaline battery holder in place of the NiMH battery pack, insert fresh cells into the battery holder and place the holder in the battery compartment (refer to the *Alkaline Battery Holder* instructions later in this section for details).
- 5) The first time you turn the Allegro on, it boots to Windows CE.

Details about battery life, recharging the battery pack, the battery status LED indications, power management features, and removing and inserting battery packs are located in this section of the manual.

## **Battery Life**

Depending on your application, the batteries can last from 5 to 30 hours between charges (NiMH) or replacement (alkaline cells) as shown below:

<u>Battery Pack</u>	<u>Capacity</u>	<u>Typical Operating Time</u>
NiMH	3,800 mA hours	12 to 20 hours
Alkaline	1,600 mA hours	5 to 8 hours

The operating time stated above are based on a typical application where: the Allegro performance level is set to medium, the Power Manager is on, data are being entered manually on the keyboard, no external devices are powered by the Allegro, the backlight is used 10% of the time, and processing time is 20%. The actual operating time could vary from as little as 5 hours to as much as 30 hours, depending on your program and how the system is set up.

## **Recharging the NiMH Battery Pack**

For applications where the Allegro is used for several hours each day, the NiMH batteries can be charged daily. The Allegro's built-in intelligent charging circuit manages the charging of the batteries and prevents them from being overcharged. For less frequent use, the batteries should be discharged below 80% before they are recharged for maximum battery life.

You should always be aware of the status of the main batteries before you go out into the field to collect data. The batteries may need to be recharged before you go. You need to take into account how much battery life is left and the amount of time required to charge the pack.

### *Temperature Ranges for Charging the NiMH Battery Pack*

The Allegro's NiMH batteries are charged most efficiently at temperatures ranging between 10° to 20° C (50° to 68° F) when the AC power adapter is used. The Allegro batteries must be charged when the battery temperature is between 0° to 40° C (32° to 104° F) due to the nature of NiMH batteries. The chart below describes the Allegro battery charging behaviour at different temperatures

	Temp. Range <u>Degrees C</u>	Temp. Range <u>Degrees F</u>	Charging Behaviour
Recommended Charge Range	10° to 20°	50° to 68°	Most efficient; batteries charge within 3 hours
Acceptable Charge Range	0° to 30°	32° to 86°	Batteries are charged within 4 hours
Too Cold Range	<0°	<32°	The batteries must reach 0° C (14° F) before they begin to charge
Too Hot Range	>30°	>86°	Battery charge cycle is complete in 4-5 hours. If the batteries have become too warm, they may only reach a 90 to 95% charge capacity

Try to charge the batteries within the recommended temperature range. If you need to charge the batteries in temperatures exceeding this range, you should purchase an extra battery for the most efficient operation of the Allegro.

#### *Power Connector*

A dedicated standard external DC power input connector is located on the top of the Allegro. The connector is 5.5 x 2.1 mm, 10 to 20 VDC. The AC power adapter and optional cigarette lighter power adapter are inserted into this connector.

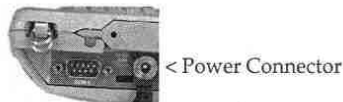

#### *Charging Accessories for NiMH Battery Packs*

- ' AC Power Adapter: Using the AC power adapter, the battery pack is recharged without removing it from the Allegro. Please note that you must use the adapter included with the Allegro or one that is capable of supplying adequate current (12 V at 1 Amp). Otherwise, your battery pack could be damaged. You can run the Allegro from the adapter while the batteries are being charged. Plug the AC charging adapter into an AC outlet and insert the connector into the external power input jack located on the top of the Allegro case. It may take up to five hours to fully charge a battery pack. When the batteries are fully charged, the charging circuit switches into trickle charge mode. You can leave the Allegro connected to the adapter continuously without overcharging or damaging the batteries.
- ' Cigarette Lighter Power Adapter (optional). With this adapter, you can charge battery packs via an automobile cigarette lighter. Plug the adapter into the cigarette lighter and insert the connector into the external power input jack located on the top of the Allegro case. It takes from 3 to 5 hours to fully charge a pack. You can

operate the Allegro with this adapter as well as charge the batteries.

- ' External Battery Charger (optional): The battery pack is removed from the Allegro to be charged using the external battery charger. Place the NiMH battery adapter on the charger. Slide the battery onto the charger and leave it for six hours. Refer to the instructions that came with the charger for more details. (Details on how to remove the battery pack are located later in this section of the manual).

### *Using Vehicle Power*

It is important to have the Allegro in Vehicle Mode when it is connected to vehicle power, either directly or via the cigarette lighter power adapter. Vehicle Mode prevents excessive charging of the NiMH battery pack.

Using Vehicle Mode is necessary because every time the key is turned off the Allegro begins a new battery charge cycle. The Allegro circuitry detects when a battery pack is fully charged, however, it takes approximately twenty minutes for this to occur. Repeatedly attempting to charge a fully charged battery pack causes premature degradation in battery performance. In Vehicle Mode, charging is inhibited if the gauging circuitry indicates that battery pack is above 90% charged.

To put the Allegro in Vehicle Mode, follow these steps (the default is for Vehicle Mode to be off):

- From Windows CE: go to *Control Panel/Power Properties/Battery* and select the In-Vehicle Charge Mode option (Refer to *Allegro Owner's Manual, Section 4, Windows CE, Control Panel* for details).
- From DOS: go to the *System Setup Program/Power Management* screen and select "Yes" for the Vehicle Mode option (refer to *Allegro Owner's Manual, Section 5, MS DOS, System Setup Program* for details).

### **Resume Versus Reboot**

The first time you turn the Allegro on after you receive it, the Allegro boots to Windows CE, the system default. Each time you replace the batteries, the Allegro *resumes* to the operating system it was in and the screen that was last displayed before the batteries were removed. Example: You are editing a Ptab document in Windows CE. To change the battery pack, you save the document but do not close it, turn the Allegro off, change the battery pack (within five minutes), and turn the Allegro back on. The Allegro automatically resumes to the Ptab document you were editing.

If the batteries are removed from the Allegro for longer than five minutes, the Allegro *reboots* to the last operating system it was in, but it does not resume to the screen that was last displayed before the batteries were removed. The Windows CE Desktop or the DOS prompt appears.

### **Battery Gauging**

The Allegro's intelligent battery gauging circuit helps you efficiently maintain the batteries

for your applications. The percentage of remaining charge in the batteries is indicated through the battery status LED indicators. The gauging works for both NiMH rechargeable batteries and alkaline batteries, although the mechanism is different, as outlined in this section.

*Important Note: Battery gauging is provided as a tool to help you manage your batteries. It does not affect the performance of the Allegro or the batteries in any way. If the gauging circuitry is not properly synchronized with a NiMH battery, it may show erroneous readings. Please read this section on battery gauging so you understand the proper setup, functionality, and limitations of battery gauging.*

#### *How Battery Gauging Works for the NiMH Rechargeable Battery*

The Allegro employs a circuit that watches how much charge is added to or removed from the rechargeable battery. To illustrate how this circuit works, imagine the battery as a tank of water. The battery capacity is like the size of the tank in gallons. Watching charge is like watching how many gallons of water flow into or out of the tank. Gauging the battery is like gauging how full the tank is, without being able to see into it. You must know the size of the tank and how full it was to start with to determine the amount of water in the tank. As water flows out of the tank, the percent full can be calculated by subtracting how much water has flowed out of the tank from the starting point and then dividing by the capacity of the tank. This is exactly what the Allegro does, except it monitors milliamp-hours of electric charge instead of gallons of water

For the battery gauging to work correctly on the Allegro, the following values must be known about the NiMH battery pack:

- Charge percent
- Capacity

The battery gauging is set in the following ways:

- 1) The charge percent and capacity values are set at the factory for the battery pack. Once you fully charge the battery pack using the AC charging adapter (the pack is shipped in a discharged state), the gauging is automatically set correctly. You do not need to set it manually
- 2) When you remove and insert a battery pack, a popup window appears asking you to select the charge percent and capacity. The popup window is described later in this section under *Setting Battery Gauging From the Battery Popup Window*. Please note that if either of these values are incorrect, the gauging is not accurate.

The battery gauging is an estimate. It works well in applications where the Allegro is used and charged every day. When it is not used much and goes several days between charges, the gauging may not be as accurate in reflecting the true charge of the battery pack. The accumulated error can be up to 5% per day. To avoid errors, keep the Allegro attached to the AC charging adapter when you are not going to use it for a few days. This practice prevents the battery pack from self-discharging. The battery stays fully charged and the battery gauging reflects the correct status of the battery pack.

#### *How Battery Gauging Works When Using Alkaline Batteries*

Alkaline batteries have a better slope to the voltage discharge curve than NiMH batteries. Because of this, the voltage can be read directly to gauge the battery charge percent.

The gauging may vary depending on the grade and brand of the batteries being used. For best results, we recommend you use the new types of alkaline batteries such as the Duracell Ultra™ and Energizer Titanium™. Also, temperature and loading affect alkaline battery voltage and may cause the gauging to behave differently in different environmental conditions. When moving from a cold environment to a warm one the battery charge LED indicators may move up instead of down. This happens because in cold temperatures alkaline batteries have less charge capacity than in warm temperatures and this is reflected in the voltage output.

### *Battery Status LED Indicators*

There are five LEDs. Depending on which LED is lit, starting left and moving right, the battery charge remaining is as follows:



<u>LED</u>	<u>Status</u>	<u>Indicator</u>	<u>Battery Charge Remaining</u>
1	Blinking	Low Voltage	0 to 10%
1	Steady Light	Charge Flow	10% to 20%
2	“	“	20% to 40%
3	“	“	40% to 60%
4	“	“	60% to 80%
5	“	“	80% to 100%

*Important Note: The LED indicators are meant to give only an approximate indication of battery charge remaining, not an exact reading.*

When the battery charge drops to 10%, the voltage begins to drop off rapidly. When the Allegro detects this low battery condition, the battery status LED indicator farthest to the left begins to blink to let you know it is time to recharge or replace the batteries. You have from ten minutes to one hour (depending upon power consumption rate) to save you data and exit your program.

When the battery pack voltage drops sufficiently, the Allegro automatically goes into suspend mode. Charge or replace the batteries as soon as possible. The battery pack has enough charge left to retain the system RAM for a short period of time, at which point the Allegro completely powers down to prevent damage to the batteries. If this happens, the Allegro reboots after you charge or replace the batteries. Any data that were not saved to disk are lost.

### **Charging Indicator**

When the rechargeable batteries are being charged via the AC power adapter or the vehicle cigarette lighter power adapter, the LED underneath the charging indicator is lit. When the batteries are fully charged, the LED turns off. Note that when the LED turns off, the batteries continue to receive a trickle charge.



If the charging indicator LED does not light up when you plug the Allegro into a charger, the battery has a 90% or higher charge and does not need to be charged. Batteries should be discharged below 80% before they are recharged for maximum battery life.

### **Windows CE Battery Status Icons - WIN CE**

In addition to the LED indicators, when you are in Windows CE icons appear on the Taskbar in the system tray that indicate the battery status of the main battery and the CMOS battery.



Batteries are charging while the Allegro is being operated



Powered by the battery pack, charge is low



Powered by the battery pack, charge is very low



CMOS backup battery is low

### **Power Management Features**

To conserve power, the Allegro has the following built-in power management features: Auto Suspend and Power Manager. These features are controlled through the *Control Panel/Power Properties* program in Windows CE and the *System Setup Program/Power Management* screen in DOS.

#### *Auto Suspend*

When the Auto Suspend feature is on, the Allegro turns itself off if there is no activity after a specified period of time. The time ranges are from 5 to 75 minute increments. Auto Suspend monitors both keystrokes and processor activity.

#### *Power Manager*

The BIOS Power Manager is a sophisticated mechanism which automatically speeds up and slows down the system CPU based on the level of activity. Activities monitored include keypresses, serial port activity, changes to video memory, file system activity, and PC card activity. When there is a high degree of activity, the system runs at a faster rate. When there is a lesser degree of activity, the system runs at a slower rate, consuming less power. If the Power Manager is enabled, the CPU Performance setting affects the range of speeds at which the CPU runs. When the Power Manager is turned off, the CPU Performance setting causes the CPU to run at a fixed clock speed.

In Windows CE, the Power Manager is built-in. In DOS, you can leave it on (default) or turn it off. Because the Power Manager can greatly extend the life of the batteries, we recommend that you run the Allegro with the Power Manager on and the CPU speed set to medium.

You can gain even more power management efficiency within your application program by

following the recommended power management techniques discussed in *Section 7 and Section 8* of the Allegro Owner's Manual.

### **NiMH Battery Pack: Changing and Setting Gauging**

The battery compartment is accessed through door in the back of the case. To open the battery compartment door, push up on the release latches on the sides of the case. The door pops open. When you close the battery compartment door, the latches automatically lock the door into place and seal the compartment. Make sure that the slide latches are completely closed.

Before you remove an existing battery pack from the Allegro, exit from open programs and turn the Allegro off. To remove a battery pack, slide it towards the left side of the battery compartment and pull it out. To insert a NiMH battery pack, place it in the left side of the battery compartment and slide it all the way to the right.



#### *Setting Battery Gauging From the Battery Popup Window*

Whenever a NiMH battery is inserted into the Allegro and it is turned on, a popup window is shown directing you to select values for battery charge percent and battery charge capacity. These values must be set correctly for the battery gauging function to work properly, as outlined earlier in this section of the manual.

If you are in Windows CE, the following window is shown:



If the *Battery is fully charged option* is selected, the charge percent defaults to 100%. If the *Keep current charge value* is selected, the charge percent shown reflects the charge percent of the previous battery.

If you are in DOS, the window appears as follows:

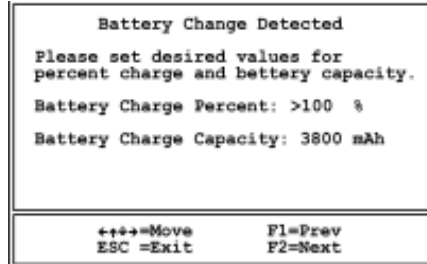

### Setting the Battery Charge Percent

Based on the status of the battery pack, follow the recommendations below to set the battery charge percent. (In Windows CE press the arrow keys to increment the numbers up or down. In DOS, use the <F1> and <F2> function keys).

<u>Battery Status</u>	<b>Correct Selection/Setting</b>	
	<u>Windows CE</u>	<u>DOS</u>
Fully charged	Battery is fully charged	100% (default)
Removed and replaced without charging	Keep current charge value	Last
Uncertain, can estimate	Select charge from 10 to 100%	Select charge from 10 to 100%
Uncertain, can't estimate	See suggestions that follow	See suggestions that follow

If you insert a battery pack and do not have a good idea what the status of it is, we recommend that you do one of the following:

- 1) Set the charge to 10%, plug the Allegro into the AC wall charger, and fully charge the pack for 3 to 5 hours. Once the battery pack is fully charged, the gauging is automatically set to 100% and the battery LED indicators accurately reflect the battery charge.
- 2) Say okay to the default setting (battery is fully charged). Initially the 5<sup>th</sup> LED is lit. Depending on the actual battery charge percent, you could see it jump rapidly to the first LED. When this LED begins to blink, fully charge the battery. Once the battery pack is fully charged, the gauging is automatically set to 100% and the battery LED indicators accurately reflect the battery charge.

### Setting the Battery Charge Capacity

The Charge Capacity field should be set to the charge capacity of the newly installed battery pack in milliamp-hours (mAh). The charge capacity of the NiMH batteries we have provided for the Allegro are as follows:

Gold Peak™ (GP) VR151    3800 mAh

Empire™  
Duracell™ DR9

3500 mAh  
3000 mAh

If you purchase a battery pack from another vendor, note what the capacity is. For optimum performance, it is best to use battery packs with a 3000 to 4000 mAh capacity. The higher the capacity of the battery pack, the longer it holds a charge. Battery packs with a capacity over 4000 mAh do not charge fully.

As a battery pack ages, it does not operate as long on a charge as it did when it was new. The capacity could be reduced by as much as 50% at the end of its useful life. Over time, the capacity setting for an individual battery pack may need to be adjusted downward to account for age.

### **Alkaline Battery Holder: Inserting Batteries and Usage Information**

The alkaline battery holder enables you to power the Allegro Field PC with alkaline batteries. Follow the steps outlined below for proper usage.

- 1) Exit from any open programs and turn the Allegro off before changing the batteries.
- 2) The Allegro battery compartment is accessed through a door in the back of the case. To open the compartment door push up on the release latches on the sides of the case. The door pops open. Remove the NiMH pack or alkaline holder by sliding it to the left and pulling it out.
- 3) Open the door to the alkaline battery holder by pressing in on both tabs with your index finger and thumb as shown.



- 4) Insert three fresh AA alkaline batteries, taking care to orient them correctly (only use alkaline batteries). Always replace all three batteries at once. (Note: For best results, we recommend that you use the new types of alkaline batteries such as the Duracell Ultra™ and Energizer Titanium™.)
- 5) Slide the door to the alkaline holder back into place, making sure it snaps securely shut.
- 6) Place the alkaline battery holder in the left side of the Allegro battery compartment. Put gentle pressure on the holder while sliding it all the way to the right.
- 7) Press down on the Allegro battery compartment door to close it. The latches should automatically lock the door into place and seal the compartment. Make sure that the slide latches are completely closed.

- 8) While you are using the Allegro Field PC, occasionally check the battery LED indicators above the Allegro display. When the battery power gets low, replace the alkaline batteries or insert a NiMH pack.

#### *Important Information Regarding the Use of Alkaline Batteries*

The Allegro Field PC is designed to be used with the rechargeable NiMH battery pack that came with the unit. The alkaline battery option should be considered as a backup to the NiMH battery pack, not as the main source of power for an extended period of time. Alkaline batteries have a lower capacity and a higher resistance than NiMH batteries. Thus the battery life and performance of the Allegro are reduced when alkaline batteries are used. The Allegro runs as described below:

- ' The clock speed automatically switches down to a maximum speed of 33 MHz
- ' The display heater cannot be used
- ' As the batteries are drained, the Allegro automatically switches to a slower clock speed and limits the backlight intensity to further reduce power consumption and prevent the unit from turning itself off because of power demands
- ' Battery life ranges between 2 and 8 hours (this is highly dependent on the temperature)

If you have been using alkaline batteries in the Allegro and switch to a NiMH battery pack, the clock speed and backlight brightness setting automatically return to the levels they were previous set at.

#### **Storing the Allegro During Inactive Periods**

To protect the Allegro and your files during long or short-term storage periods, please take the following precautions:

- Save all data and programs you want to keep to disk.
- Store the Allegro in a cool location (<20°C, 68°F).

Your data and programs are secure as long as they have been saved to disk, even if the batteries become discharged. The data storage disk is non-volatile. It does not depend on the battery to store the data for extended periods.

#### *Storing the Allegro for Less Than Two Months*

If you store the Allegro for less than two months, we recommend that you leave the NiMH battery pack in the Allegro and attach the AC power adapter to keep the batteries charged. Once the battery pack is fully charged, the Allegro switches to trickle charge mode. You can leave the Allegro in trickle charge mode continuously without damaging the batteries. The battery pack will be fully charged when you are ready to use the Allegro.

#### *Storing the Allegro for More Than Two Months*

If you store the Allegro for more than two months, remove the battery pack and attach the AC power adapter to prevent the internal lithium backup battery from draining. When you are ready to use the Allegro, insert a battery pack and fully charge it if necessary.

### **NiMH Battery Pack's Useful Life**

Battery packs can be recharged approximately 600 times before they need to be replaced. This is dependent on the temperatures they have been exposed to, operating conditions, and charging and discharging practices.



#### *Recycling the NiMH Batteries*

The NiMH batteries inside the Allegro battery packs are recyclable. We are voluntarily participating in an industry program to collect and recycle these batteries when they are taken out of service in the United States or Canada. The recycling program provides a convenient alternative to placing used NiMH batteries into the trash or the municipal waste stream. Our involvement in this program is part of our commitment to preserving our environment and conserving our natural resources.

Because most battery recycling bins available for public use do not accept NiMH batteries, you are welcome to return the spent battery packs used in the Allegro to our office and we will recycle the batteries for you. If you plan to do this, please contact us for information on how to properly package and ship the batteries.

### **Spare NiMH Battery Packs**

Spare battery packs should be stored in a cool location. Avoid placing battery packs "contact side" down on a metal surface. Also, do not stack packs so that their contact touch one another. These practices will cause the batteries to drain. The shelf-life of a battery pack is about two months. Before using a spare pack, you should charge it.

## **7.2 Short-Term Back Supply**

The Allegro has a super capacitor that behaves like a backup battery. When the main batteries are removed, the capacitor maintains the RAM for up to 5 minutes, allowing you plenty of time to change the batteries. The capacitor cannot operate the Allegro. The capacitor is charged by the batteries. It holds a charge as long as the batteries or external power are supplied. When a battery pack is replaced, the capacitor charges up to full capacity in about 2 minutes.

# 50-60 HZ SWITCH

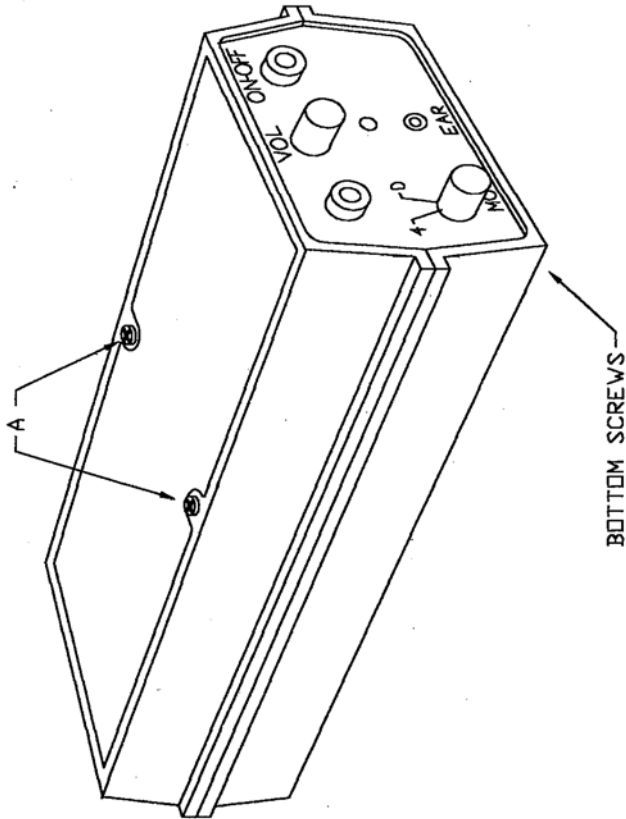

- REMOVE TWO SCREWS-A
- REMOVE FOUR BOTTOM SCREWS
- LIFT THE TOP COVER
- LIFT ALL PC BOARDS OUT OF BOTTOM COVER
- PULL OUT FRONT AND REAR PANEL ASS'Y
- 50-60 HZ SWITCH IS ON DIGITAL PCB AS SHOWN
- ASSEMBLY THE UNIT IN REVERSE ORDER

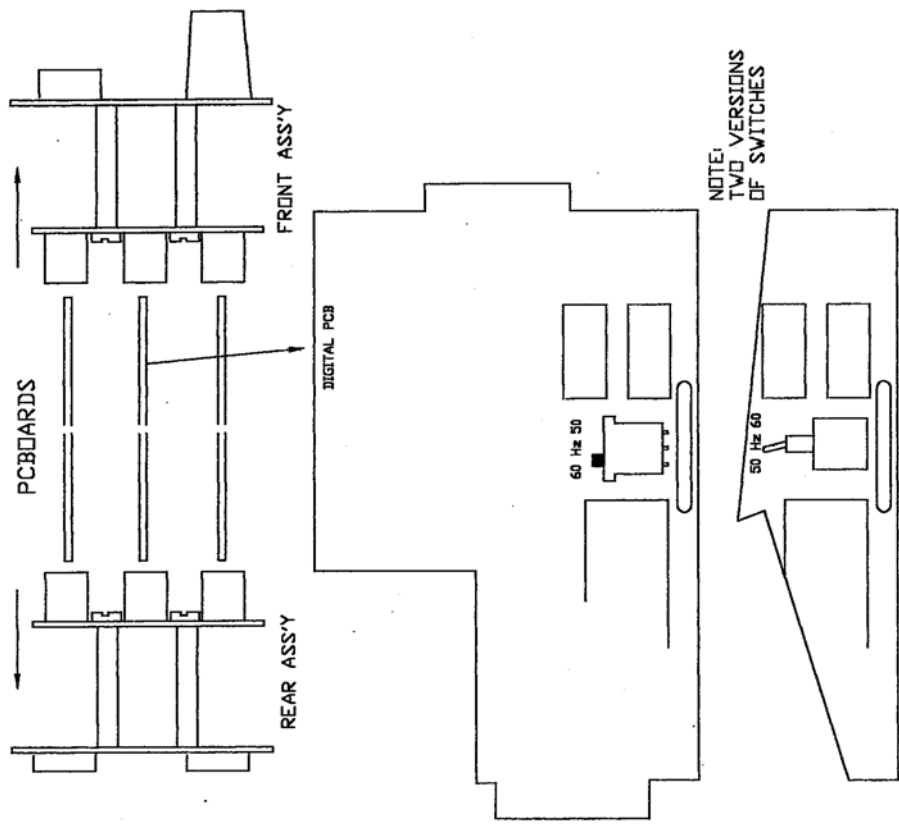

NOTE:  
TWO VERSIONS  
OF SWITCHES

EM61-MK2  
GEONICS LTD

FIG 2D.

If power is not supplied to the Allegro for more than 5 minutes, the Allegro reboots when the battery pack is replaced or charged. All the programs, data, and applications saved to the disk are safe. Information that was not saved to the disk is lost.

The super capacitor should not need replacement through the life of the Allegro.

### 7.3 Backup Battery, Real-Time Clock

A 3.6 V lithium backup battery supplies current to the Allegro to maintain the real-time clock when power is not supplied to the Allegro. This battery should last for at least 5 years.

#### *Replacing the Lithium Backup Battery*

If the Allegro does not hold the date and time or you get a CMOS error message, the lithium battery needs to be replaced. You can check and see whether or not the lithium battery is good or bad. In Windows CE, go to *Control Panel/Power Properties/Battery*. Additionally, when it is low, the following icon appears in the system tray on the Windows CE Desktop



In DOS, go to *System Setup Program/System Information Screen* to view the status of the lithium battery.

You must return your Allegro to the factory for lithium backup battery replacement.

### 8. 50 Hz/60 Hz Operation

The EM61-MK2 is designed for maximum rejection of power line interference. By proper selection of instrument repetition rate; 75 Hz for operation in countries with 60 Hz power line frequency and 62.5 Hz for operation in countries with 50 Hz power line, most but severe power line noise will be rejected by the instrument. EM61-MK2 repetition rate is normally set in the factory according to the country that the instrument was originally intended to be used. If the condition has changed, an internal switch allows changing the operation rate as shown in Figure 2D.



## 9. EM61-MK2 Technical Specifications

Measured Quantity	:	Four channels of secondary response in mV
EM Source	:	Air-cored coil, 1 x 0.5 m size
Current Waveform	:	Unipolar rectangular current with 25% duty cycle
EM Sensors	:	Bottom coil: Air-cored coil, 1 x 0.5 m in size, coincident with EM source
	:	Top coil: Air-cored coil, 1 x 0.5 m in size 28 cm above main coil
Maximum Output	:	10 000 mV
Dynamic Range	:	18 bits
Time Gates	:	Four gates of bottom coil response only, centered at 256, 406, 706 and 1306 $\mu$ sec; or, three gates of bottom coil response at 256, 406 and 706 $\mu$ sec, with one gate of top coil response at 706 $\mu$ sec, after T/O time.
System Controller	:	Allegro field computer with 486 AMD processor, 24-line LCD display with 40 characters per line.
Acquisition Speed	:	Up to 16 records (4 time gates per record) per second
Data Storage	:	24MB solid state memory for up to 1,000,000 records; extended memory, optional
Power Supply	:	12 V rechargeable battery for 4 h continuous operation
Operating Weight & Dimensions	:	Backpack: 8 kg; 60 x 30 x 20 cm
	:	Coil Assembly: 14 kg (23 kg trailer mode)
	:	Bottom: 100 x 50 x 5 cm
	:	Top: 100 x 50 x 2 cm
Shipping Weight & Dimensions	:	38 kg (70 kg with trailer)
	:	108 x 60 x 25 cm (Box 1; harness mode only)
	:	54 x 54 x 52 cm (Box 2; with trailer option)

### **Optional**

#### **Hand-held Sensor**

Time Gates	:	Four gates of bottom coil response only centered at 147, 263, 414 and 613 $\mu$ s; or three gates of bottom coil response at 147, 263 and 414 $\mu$ s with one gate of top coil response at 414 $\mu$ s after turn-off time
Sensor Size	:	33 x 20 cm
Wheel Mode Resolution	:	0.1 or 0.2 meters, switch selectable

Weight	:	With wheels	7.5 Kg
		Without wheels	2.8 Kg
Length	:	Minimum	130 cm
		Maximum	180 cm

## A1. EM61-MK2HP

### 8. Operating Notes

The EM61-MK2HP is a high power version of Geonics EM61-MK2 Metal Detector. It provides up to 8 times more target response than the standard unit, resulting in a significant increase in signal-to-noise ratio.

The following section is a note describing the functions of the EM61-MK2HP that differ from the operation of the standard EM61-MK2, as described in this manual.

#### (a) Output Power Switch

The EM61-MK2HP unit can be operated at two output power levels; a) standard power level (LO) and, b) high power level (HI). The difference in the transmitted signal between two modes is a factor of two, two times higher in "HI" position. For the maximum output signal set the Power Mode Switch located on the side of the battery pack, to the "HI" position.

For a survey that does not require maximum output power, set the Power Mode Switch to the "LO" position. With the switch in the "LO" power position the battery will last approximately 4 times longer than if the switch is in the "HI" position.

#### **Important:**

Prior to changing the power mode from "HI" to "LO" (or "LO" to "HI") the circuit breaker on the backpack should be in the "OFF" (pulled out) position.

#### (b) Two Battery Option

There are two types of batteries which can be used with this unit (normally only the high power type is supplied). A large capacity battery (32 Ah) which supplies power for approximately two-and-a-half hours in the high power mode and about 7 hours in the low power mode, and a small capacity battery (10 Ah) that will provide for about two-and-a-half hours in the low power mode. The small battery pack can only be used in the low power mode.

Figure 2HP shows the assembly procedure for both types of batteries. Note that the larger battery is substantially heavier than the smaller one; 13 kg compared with 4.5 kg, therefore the decision on which battery to use will depend on the availability of the battery, length of survey and the desired output power.

#### (c) Charging High Power Battery Pack

When charging the high power battery pack the Power Mode Switch (LO/HI) on the battery pack has to be in the "LO" position.

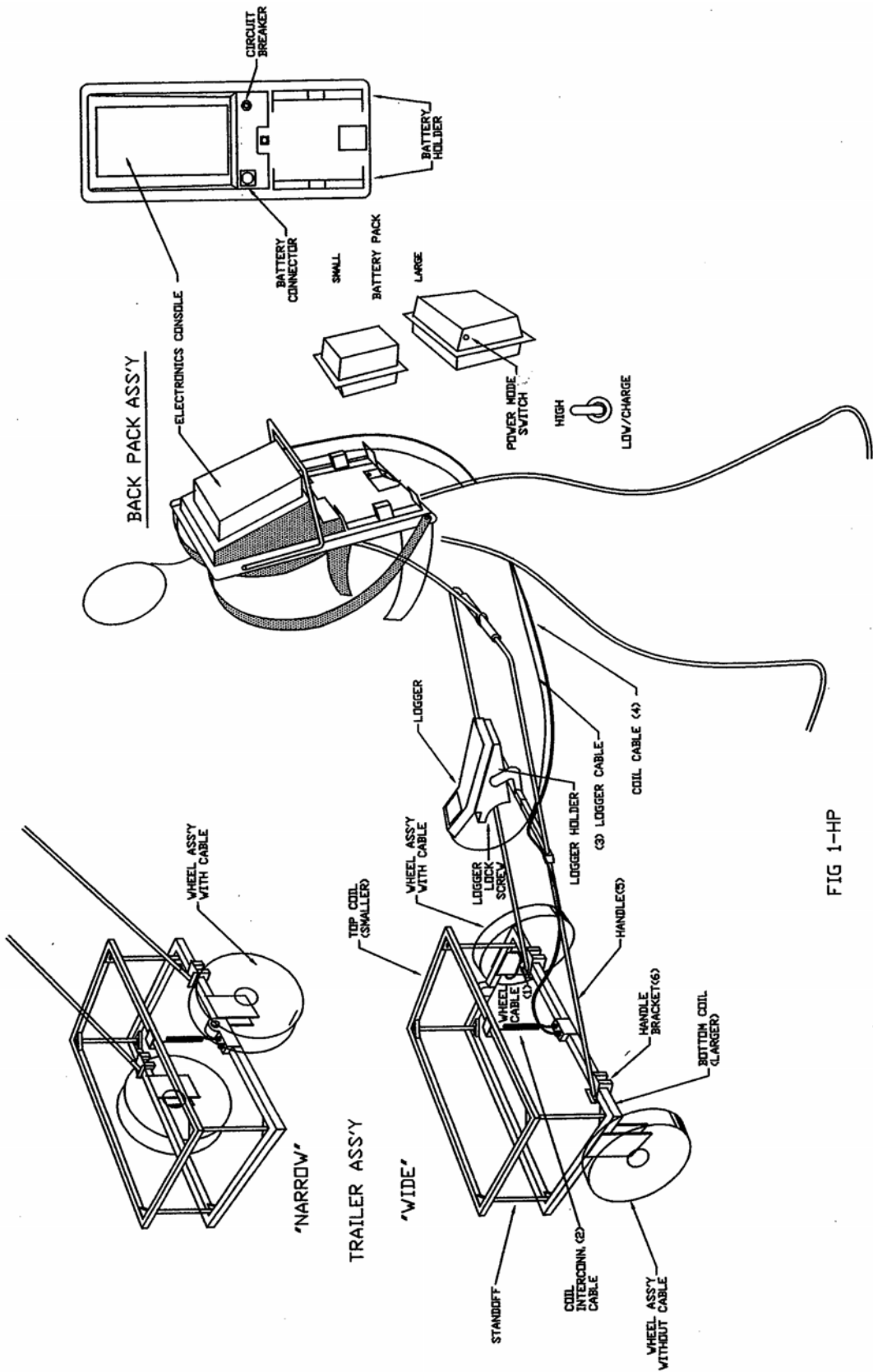
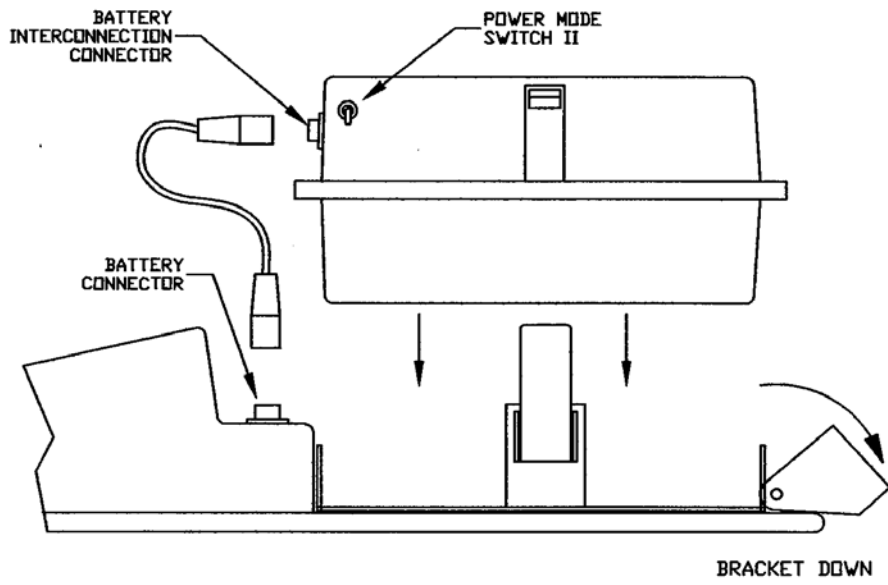

FIG 1-HP

# TWO BATTERY OPTIONS

## A. LARGE BATTERY PACK



## B. SMALL BATTERY PACK

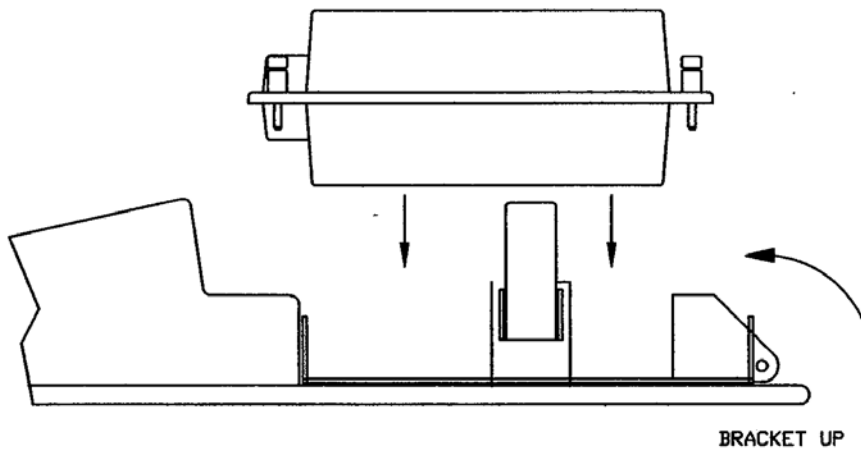

FIG 2-HP

## 2. EM61-MK2HP Technical Specifications

Measured Quantity	:	Four channels of secondary response in mV
EM Source	:	Air-cored coil, 1 x 0.5 m size
Current Waveform	:	Bipolar rectangular current with 25% duty cycle
EM Sensors	:	Bottom coil: Air-cored coil, 1 x 0.5 m in size, coincident with EM source Top coil: Air-cored coil, 1 x 0.5 m in size 28 cm above main coil
Maximum Output	:	10 000 mV
Dynamic Range	:	18 bits
Time Gates	:	Four gates of bottom coil response only, centered at 261, 376, 527 and 727 $\mu$ s; or, three gates of bottom coil response at 261, 376 and 527 $\mu$ sec, with one gate of top coil response at 527 $\mu$ sec, after T/O time.
System Controller	:	Allegro field computer with 486 AMD processor; 24-line LCD display with 40 characters per line
Acquisition Speed	:	Up to 16 records (4 time gates per record) per second
Data Storage	:	24 MB solid state memory for up to 1 000 000 records; extended memory optional
Power Supply	:	Two 12 V/16 Ah rechargeable batteries or 12 V/10 Ah rechargeable battery (for low power operation only) <ul style="list-style-type: none"><li>• 2 h continuous operation in full power mode</li><li>• 7 h continuous operation in low power mode</li><li>• 2 h continuous operation in low power mode (small battery)</li></ul>
Operating Weight & Dimensions	:	Backpack: 21 kg; 60 x 30 x 20 cm Coil Assembly: 14 kg (23 kg trailer mode) Bottom: 100 x 50 x 5 cm Top: 100 x 50 x 2 cm
Shipping Weight & Dimensions	:	92 kg (103 kg with trailer) 108 x 60 x 25 cm (Box 1; harness mode only) 54 x 54 x 52 cm (Box 2; with trailer option)

## **A2. EM61-MK2 (MK1) CALIBRATION DEVICE (QC COIL)**

### **1. Introduction**

An optional standard calibration device that can be used to check the gain calibration of Geonics Limited EM61-MK2 (MK1) UXO Detector is available. The device can be used as an “absolute” calibration, so that the different EM61 units, if calibrated with the QC coil, would under the same conditions give the same results over a particular target.

### **2. Description**

The EM61 calibration device is used to check the operation of the complete EM61 system including transmitter and both receiver coils, as well as the signal processing console.

Two types of QC coils are available: a. external and, b. internal. The external device is mounted on the side of the main (bottom) coil as per Figure 3a. It is a self-contained unit and can be used on the different units without any modification of the EM61. The internal calibration device, as per Figure 3b., uses the internal component of the receiver coil for operation and, therefore, requires system (coil) modification at Geonics manufacturing facility.

The advantage of the internal device over the external one is a smaller size and a somewhat lower cost, assuming that modification is performed prior to delivery of new units, or on the units at Geonics for repair or recalibration. Either device can be used with the EM61-MK1 or MK2 in two different modes: a. by following EM61 logger instructions, where the logger will determine, if after activating the calibration check, the reading is inside the standard values within  $\pm 5\%$  tolerances, and it will indicate if the instrument has passed the calibration test or not, or b. by comparing the value recorded during the calibration check with the standard value as per supplied table, - Table I.

Either device can be used with all three EM61 configurations: EM61-MK2 with either 1 x 0.5 coil or 1 x 1 m coil and EM61-MK1 with 1 x 1 m coil.

### **3. Calibration Procedure**

The calibration check procedure is as follows:

#### **a. External Device**

The instrument under test should be placed outdoors as for normal operation far from any larger metallic object. After the instrument nulling, the red button on the calibration device that is mounted inside of the main (bottom) coil - Figure 3a., should be pressed and held for about three to five seconds. The logger program or comparison with the standard table will determine if the unit is operating properly. We suggest that  $\pm 5\%$  deviation from the standard value is considered acceptable.

#### **b. Internal Device**

The procedure is similar to the external device, except that the internal device is mounted on the side of the coil connector box and it has two buttons: one for the bottom coil check, and one for the top. The standard value for the internal and external devices are different, due to the different geometry and components used

for two devices.

4. Table I of the Standard Value

1. EM61-MK2 with 1 x 0.5 m Coil

A. External QC Coil

B. Internal QC Coil

CH 1	- 3935 mV	- 4608 mV
CH 2	- 3660 mV	- 3574 mV
CH 3	- 2486 mV	- 2096 mV
CH 4	- 1235 mV	- 784 mV
CH T	- 386 mV	- 708 mV

2. EM61-MK2 with 1 x 1 m Coil

A. External QC Coil

B. Internal QC Coil

CH 1	- 1052 mV	- 694 mV
CH 2	- 929 mV	- 533 mV
CH 3	- 644 mV	- 319 mV
CH 4	- 320 mV	- 120 mV
CH T	- 64.2 mV	- 81 mV

3. EM61 with 1 x 0.5 m Coil

A. External QC Coil

B. Internal QC Coil

CH B	- 2300 mV	- 2008 mV
CH T	- 324 mV	- 590 mV



4. EM61 with 1 x 1 m Coil

A. External QC Coil

B. Internal QC Coil

CH B - 540 mV

- 293 mV

CH T - 52 mV

- 67 mV

5. External QC Coil Mounting

To mount the external QC coil, set it tightly against the corner of the EM61 bottom coil, and mark the drilling hole using two holes on the QC coil as a guide. Drill using #10 (5 mm diameter) drill bit through the support corner. Use two supplied stainless steel screws to fix the Q coil on the bottom coil. It is very important that the QC coil is mounted on the bottom coil in such a way that it sits tightly against all three sides of the bottom coil corner. Even a small gap between the QC coil and the bottom coil corner will introduce an error in the test reading.

6. EM61-MK2 Recalibration

In case the QC coil test readings are outside the standard values (Table I.), a set of internal control potentiometers can be used to readjust EM61 gain. We recommend that the adjustment is done only if the deviation from the standard values is between  $\pm 5$  to  $\pm 20\%$ . For units that QC reading is outside 20% contact Geonics. Calibration adjustment should be performed only by a qualified technician.

6.1 Gain Adjustment Procedure

To get access to the Gain control potentiometers remove the electronic console from the backpack and proceed as per instructions on Figure 4. The Gain of the main (bottom) coil is adjusted by Trimmer R54, and the top coil Gain by Trimmer R23.

SKETCH OF EXTERNAL QC COIL

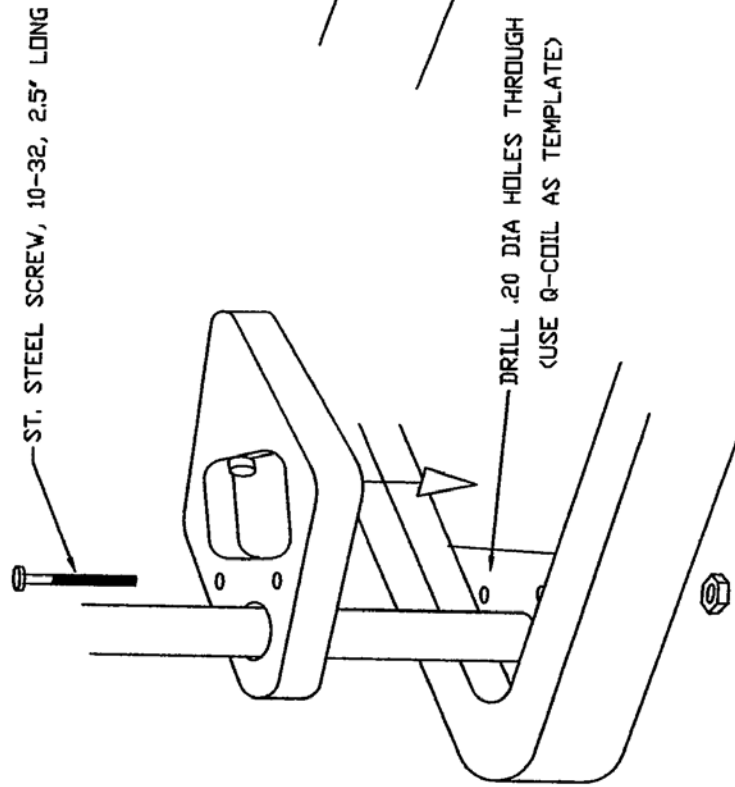

FIG 3a

SKETCH OF INTERNAL QC COIL

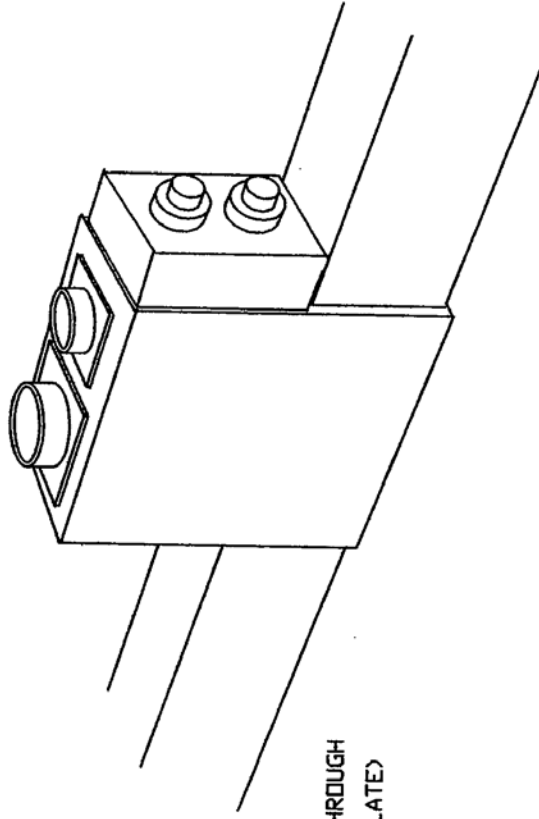
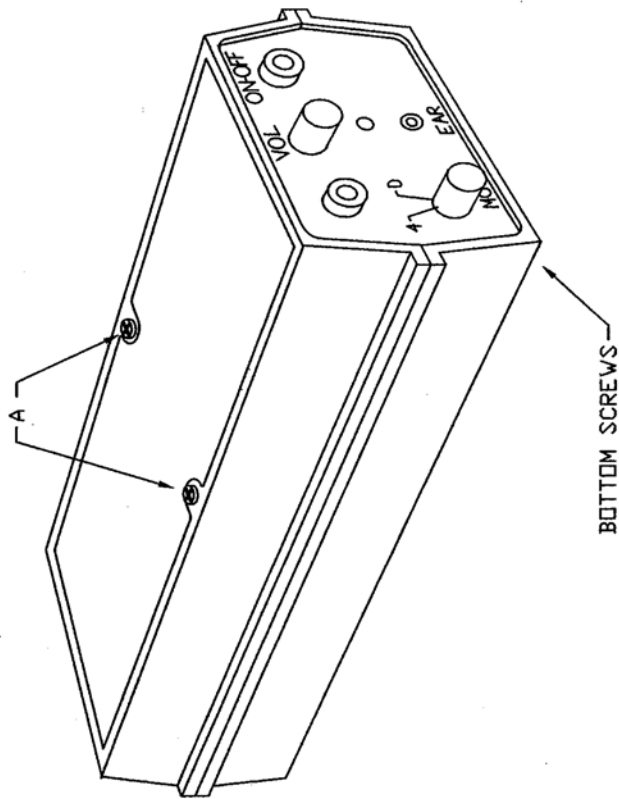

FIG 3b

EM61-MK2 RECALIBRATION



- REMOVE TWO SCREWS-A
- REMOVE FOUR BOTTOM SCREWS
- LIFT THE TOP COVER
- MAKE ADJUSTMENTS ON TOP EXPOSED PCB
- ASSEMBLY THE UNIT IN REVERSE ORDER

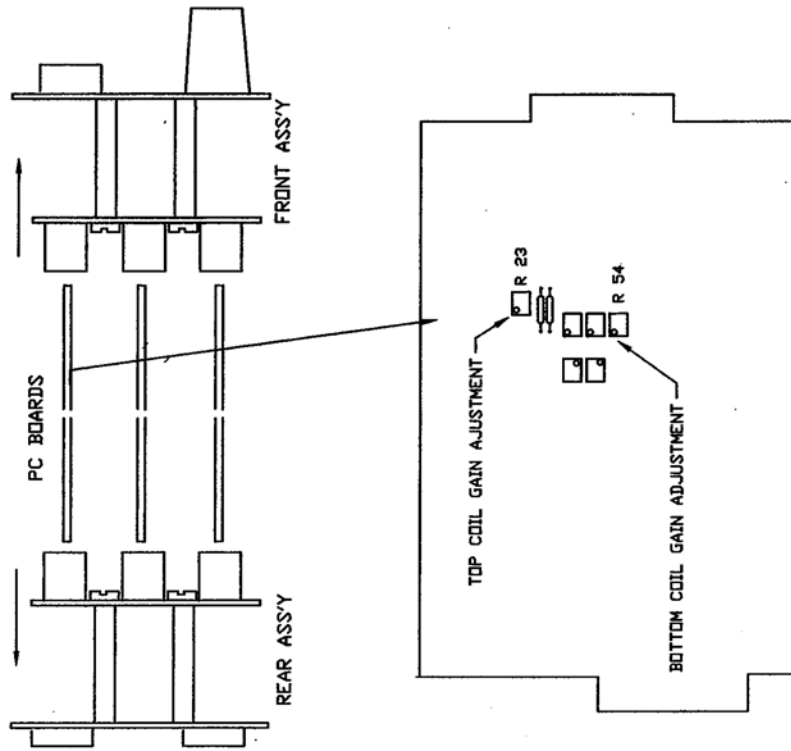

FIG 4

## EM61-MK2HP

The following table (Table II) gives the standard values for EM61-MK2HP units. Note that only the external QC Coil can be used. A special QC coil mounting support frame as shown in Figure 5, has been used.

### 7.1 Calibration Procedure

The calibration check procedure is as follows:

The instrument under test should be placed outdoors as for normal operation far from any larger metallic object. After the instrument nulling, the red button on the calibration device that is mounted as per Figure 5., should be pressed and held for about three to five seconds. The logger program or comparison with the standard table (Table II) will determine if the unit is operating properly. We suggest that  $\pm 5\%$  deviation from the standard value is considered acceptable.

### 7.2 Table II of the Standard Value

#### 1. EM61-MK2 with 1 x 0.5 m Coil

##### A. External QC Coil

	Hi Power	Low Power
CH 1	- 2400 mV	- 1130 mV
CH 2	- 2010 mV	- 940 mV
CH 3	- 1560 mV	- 730 mV
CH 4	- 1120 mV	- 540 mV
CH T	- 1690 mV	- 810 mV

### 7.3 External QC Mounting

Figure 5 shows the position of the external QC coil mounted on a special QC coil frame that can be purchased from Geonics Limited. The QC coil has to be positioned in the middle of the support frame that is slightly off from the center of the bottom EM61-MK2HP coils.

EM61-MK2HP

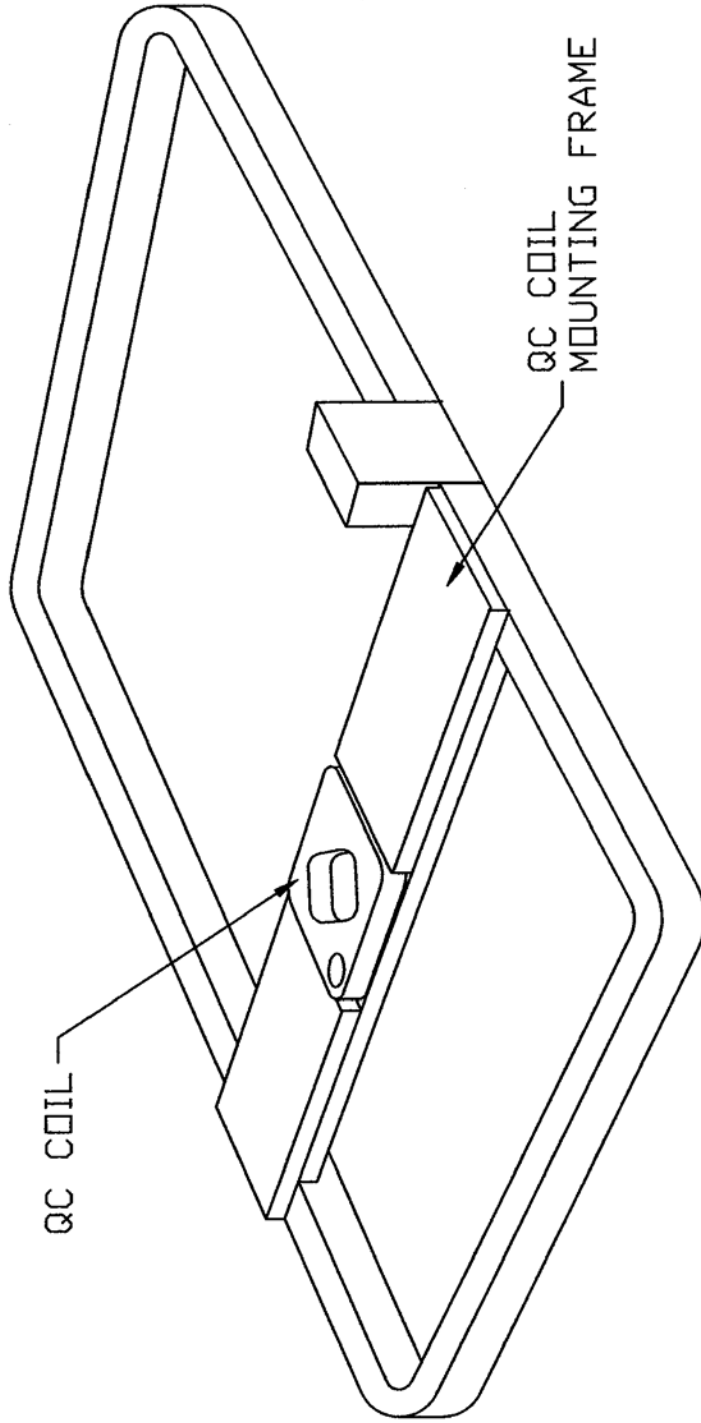

FIG 5

**B. EM61-MK2 DATA LOGGING SYSTEM**

# OPERATING INSTRUCTIONS

EM61MK2 DATA LOGGING SYSTEM  
FOR FIELD COMPUTER Allegro CX Field PC

# EM61MK2

Version 1.10

November, 2006

## Geonics Limited

---

1745 Meyerside Drive, Mississauga, Ontario, Canada L5T 1C6  
Tel: (905) 670 9580 Fax: (905) 670 9204

*E-mail: [geonics@geonics.com](mailto:geonics@geonics.com)*





# Table of Contents

1.	Introduction .....	1
1.1	Program Requirements .....	2
1.2	Installing EM61MK2 .....	2
1.3	Data Files Transfer .....	2
1.4	Running EM61MK2 Program .....	3
1.5	Main Menu .....	3
	Short description of Main Screen options .....	4
2.	Survey Setup .....	5
3.	Logger Setup.....	9
4.	Set Port for GPS.....	13
4.1	Monitoring GPS Receiver Output .....	15
5.	Set Output Port .....	17
6.	Display Options .....	21
7.	Logging Data .....	23
7.1	Monitoring Mode .....	23
	Description of Monitoring Mode options.....	25
7.2	Stand By Mode.....	31
7.3	Logging Mode.....	32
7.4	Stand By Mode Field Options .....	33
8.	View Data Files.....	43
	Appendix A .....	47
A.1	Description of Data File in EM61MK2 Allegro CX Format.....	47
A.2	Conversion Factors .....	50
A.3	Example of File in EM61MK2 (Allegro CX) Format.....	52
	Appendix B .....	53
B.1	Using the EM61MK2 with a GPS Receiver.....	53
B.2	Description of GGA and GSA Data Messages.....	54
B.3	Example of Converted Output Format .....	55



---

# 1. Introduction

The Geonics EM61MK2 Data Logging System (DAS70-CX) consists of a field computer Allegro CX, data logging program EM61MK2, and associated cable to connect the Allegro CX to the Geonics EM61-MK2 instrument. The program EM61MK2 is designed for the Allegro CX field computer and its MS Windows CE.NET V4.2 operating system.

The EM61MK2 program acquires and records survey data from the EM61-MK2 system, under the control of the operator. It also records various field information such as survey line number (line name), starting station, increment, comments, etc. Readings are displayed in graphic and text mode. Readings are displayed in real time in mV. In addition, the program allows you to monitor the instrument output while data is not recorded. The EM61MK2 program continuously monitors the condition of the instrument battery, without leaving the program. The EM61MK2 also provides the possibility of automatic nulling of the instrument output at any time during the survey.

The program allows the user to set the EM61-MK2 into a specific instrument mode of operation: AUTO, Wheel, or Manual modes. In AUTO mode readings can be automatically recorded in desired time intervals. In WHEEL mode readings are triggered by a counter installed at the EM61-MK2 wheel assembly, and in MANUAL mode readings are triggered manually by the operator.

The program supports the standard EM61-MK2 instrument as well as EM61-MK2 High Power unit. The program allows you to record data while using various EM61-MK2 antenna (1 x 0.5 m, 1 x 1 m, or 0.5 x 0.5 m sensors) and Geonics EM61HH-MK2 Hand Held sensor.

The EM61MK2 will accept NMEA-0183 compatible data from a GPS receiver directly connected to an Allegro field computer. GPS data which are embedded in the EM61MK2 data file can be processed later in the Geonics DAT61MK2 program. The connected GPS must be able to stream NMEA-0183 compatible messages. The EM61MK2 uses two NMEA messages GGA and GSA. While message GGA is mandatory, the GSA string is used only to provide information related to the GPS signal quality during data collection.

The EM61MK2 program records data together with a time stamp at each station. Data files created with this program can be used to position a survey according to locations recorded separately by a Global Positioning System (GPS).

Survey setup parameters are saved in a file, therefore they can be automatically used during subsequent data collection sessions.

The program has an option that allows you to view data files. Data files are saved to the programs current data directory by default. Data file names, which can be set by the program based on the computer clock or user specified, have extension names R61. Files can be transferred to a PC computer using a memory card, or by a serial or USB port using the MS ActiveSync program.

Over 1,000,000 readings can be collected in the Allegro field computer with a standard memory of 64 Mb. The maximum speed of data collection is approximately 16 readings per second assuming 1 Hz (or less) GPS input. In graphic display mode, a profile containing the last 150 data readings is displayed for each channel.

## 1.1 Program Requirements

To successfully use this software, you will need :

### Computer

Field computer Allegro CX

Installed MS ActiveSync software (Version 3.50 or later) in desktop PC, or alternatively PCMCIA memory card to transfer files.

### Geonics EM61-MK2

The EM61-MK2 instrument with associated cables.

The EM61MK2 program for Allegro CX is stored on DAT61MK2 CD disk. All necessary initial files (with extension names .INI) as well as data folder (DATA61MK2) are created in your field computer after the program is run for the first time. Check that the file EM61MK2.EXE is included in AllegroCX directory on the CD disk.

## 1.2 Installing EM61MK2

While using the Allegro CX the EM61MK2.exe file should be transferred from a desktop PC using MS ActiveSync software and USB or serial cable provided by manufacturer. Optionally the program can be transferred to an Allegro using the PC memory card.

It is recommended that the program be placed in non-volatile solid state storage. This memory is represented in the Allegro by the C\_Drive icon. In the My Computer on the Allegro, double-tap on C\_Drive icon, then folder C\_Program Files will appear. The EM61MK2 program can be placed in C\_Program Files. Folders for data files should be also created in C\_Drive, which is a safe area to store data. The program creates folder DATA61MK2 which is the default folder for EM61-MK2 files.

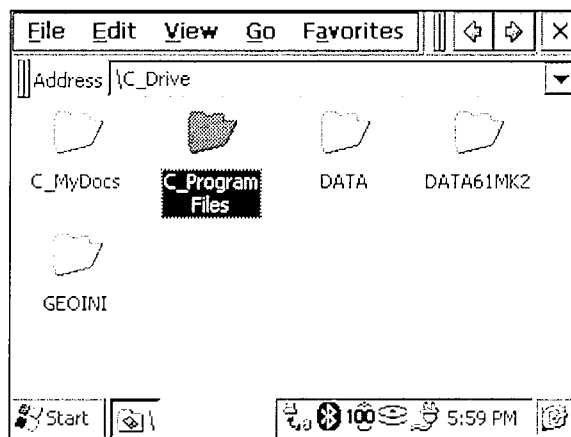

For more information about data storage options, refer to Chapter 3 of the Allegro CX manual.

## 1.3 Data Files Transfer

Data files are saved in the Allegro with extension R61. Transfer of files to desktop PC can be performed with MS ActiveSync or by PC memory card. Data files with extension R61 are binary raw data files. These files have to be converted to DAT61MK2 format with extension M61 (option "Convert Files" in DAT61MK2). Then they can be loaded and processed in the DAT61MK2 program.

## 1.4 Running EM61MK2 Program

To run the EM61MK2 locate program in C\_Program Files and double-tap program icon. The EM61MK2 is a Windows CE based, button and dialog driven program designed to be simple to use. Although the program fully supports touchscreen interface, the keyboard entry may be more convenient in most field applications. The EM61MK2 can be fully operated from the keyboard when touchscreen functions are disabled by the user.

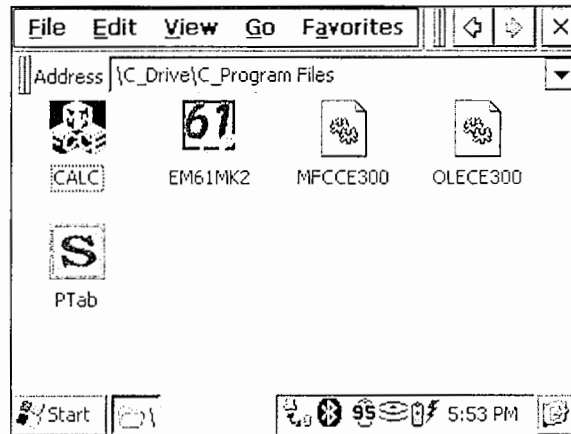

Options represented by the command buttons can be accessed by a single tap on the button. Buttons can also be selected from the keyboard by using shortcuts (pressing key corresponding to underline letter in button caption or by selecting button by pressing **TAB** and then execute by pressing **ENTER**. Shortcuts are the fastest way of accessing options represented by buttons.

Most options in the dialog windows are given in the form of text boxes and drop-down boxes which can be accessed using touchscreen or by the keyboard. Each dialog window has a title bar with a caption describing the dialog function and two buttons **OK** and **X (Cancel)**. The **OK** button (or key **ENTER**) confirms dialog selection. Tapping on the **Cancel** button (or pressing **Esc** key) closes the dialog and returns to the initial selection.

## 1.5 Main Screen

The Main Screen always appears after the program is started. It contains the name of the program, its version number, and a list of buttons representing the available options. The EM61MK2 Main Screen is displayed below.

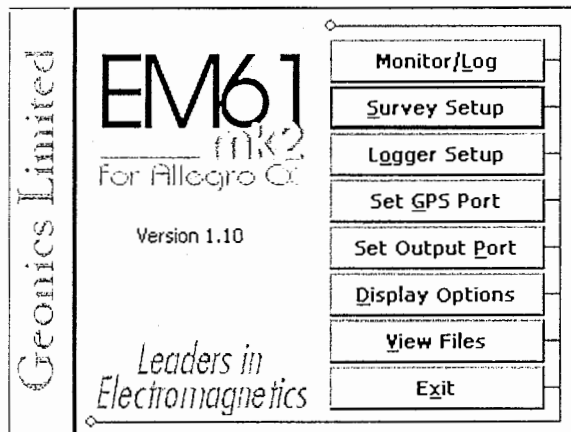

These options are selected by using tapping buttons, or from keyboard using TAB/ENTER or shortcuts indicated by underline label characters. In case of Main Screen buttons the **Down** and **Up** arrow keys and <ENTER> can be used as well.

Short description for each of the options follows.

## Short description of Main Screen options

### **Monitor/Log**

This option allows to monitor and log the EM61-MK2 output. Monitor/Log screen starts always in Monitor mode, and then after a data file is created Logging mode is available. Monitor mode provides several options: the instrument nulling, performing Internal and External QC coil calibration, monitoring EM61-MK2 and Allegro battery level, etc.

### **Survey Setup**

The Survey Setup dialog will be displayed. All survey settings (survey line name, increments, etc.) can be specified in this dialog.

### **Logger Setup**

Dialog window that is associated with this option is used to set the instrument type, antenna size, serial port number, and type of pause key.

### **Set GPS Port**

The GPS Port Setup dialog allows to disable and enable GPS data acquisition. This option is also used to set the serial port number used for GPS input and to specify necessary serial port communication settings. GPS monitoring window can be accessed from this dialog as well.

### **Set Output Port**

This option can be used to enable simultaneous output of collected data through selected serial port. Data can be sent to other logging devices, including remote computers connected by wireless modem or digital radio. This option is also used to set the serial port number used for output and to specify necessary serial port communication settings.

### **Display Options**

The dialog which will allow you to specify colour and thickness of profile lines will appear. This dialog provides also choice of linear or compressed amplitude used for profile display.

### **View Files**

This option allows to review data files saved in Allegro.

### **Exit**

This option will terminate the program execution.

## 2. Survey Setup

The Survey Setup dialog, presented below, contains several parameters which affect two important procedures: instrument settings (instrument mode, frequency of data collection, etc.) and survey geometry layout (survey line names, line spacing, start station, station increment, etc.).

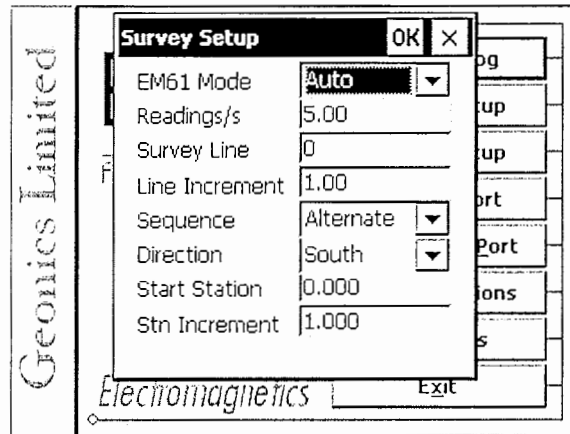

Description of Options and Parameters:

### EM61 Mode

This option allows you to select the type of instrument used. In the drop-down list box select Standard for the EM61-MK2 or High Power if EM61-MK2 High Power (HP) modification is used.

Set the EM61-MK2 mode of operation by selecting an item from the drop-down listbox labeled EM61 Mode. Available modes are: Auto, Wheel, and Manual. These modes of operation are described below.

#### Auto Mode

Readings will be triggered automatically at a specified frequency (see option Readings/s).

Please note that while in the former data acquisition system (DAS70) Stn Increment (station increment) had only two options: Positive or Negative, in the current program this value is optional.

#### Wheel Mode

Readings will be triggered automatically by a counter attached to the wheel. Wheel increment is approximately 20 cm (or 0.64 foot) for the EM61-MK2 equipped with 1 x 0.5 m or 1 x 1 m antennas. The Hand Held EM61HH-MK2 has two wheel increments 0.1 and 0.2 m. Check the wheel increment setting on the antenna assembly.

When Wheel mode is selected option Reading/s is not available, see figure below. Please note that while in former data acquisition system (DAS70) Stn Increment (station increment) had only two options: Positive or Negative, in the current program this parameter is optional and its value has to be entered according to used wheel increment.

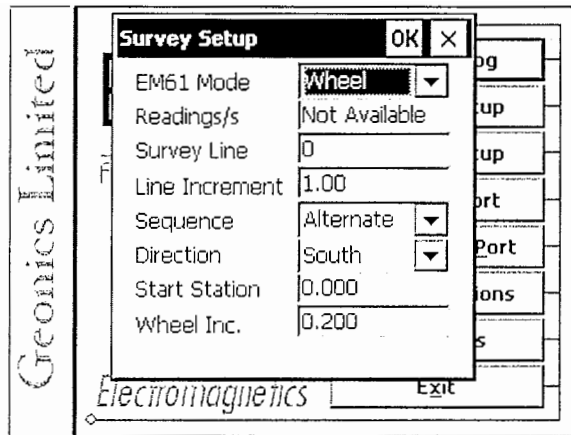

Manual Mode

Readings will be taken only while the manual trigger (switch on the logger cable) is pressed. This mode may be used only in very specific applications since the highly dynamic EM61-MK2 response requires finely spaced data points. Please note that when Manual mode is selected option is not available.

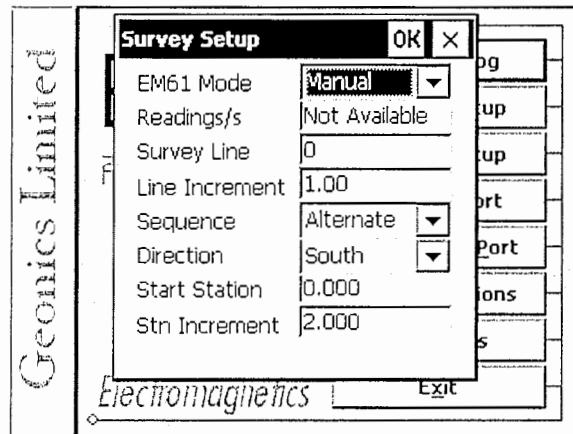

**Readings/s**

When this option is available (only in Auto mode) activate text box by tapping or using TAB key and then enter desired value.

This parameter describes number of readings per second that will be taken. Any number larger than zero can be entered, however the EM61-MK2 maximum frequency of data output is 16 readings per second.

**Survey Line** (survey line name)

Activate text box by tapping or using TAB key and then enter desired name (number) for the survey line.

This is a user's tag number/name for the profile line. The length of the name can not exceed 8 characters. The line name is usually used as a coordinate perpendicular to the survey lines direction. For example, when survey lines are laid out along W-E direction stations describe W-E coordinate, while Line names may describe S-N (vertical on a map) coordinate.

**Line Incr.** (survey line name)

Activate text box by tapping or using TAB key and then enter desired for the survey line increment.



This parameter specifies the distance by which survey lines will be separated. This setting will be used to determine number (name) of the next survey line.

### Sequence

Tapping on the down arrow next to the text box opens a drop-down box showing the available settings, or when the keyboard is used activate the text box and then by using up or down arrow keys select one of two available items: Alternate and One Way.

Alternate is used when neighboring lines are surveyed in the opposite direction, which is the most common procedure during field surveys.

One Way is used when each survey line is traversed in the same direction.

The choice of this parameter will affect the default start station, a signature of the station increment, and line direction when parameters for the next survey lines is determined.

### Direction

Tapping on the down arrow next to the text box opens a drop-down box showing the available options, or when the keyboard is used activate the text box and then by using up or down arrow keys select one of four available settings: East, West, South, and North.

This parameter indicates the heading of the survey line.

### Start Station (start station of a survey line)

Activate text box by tapping or using **TAB** key and then enter the desired value for the start station.

This parameter specifies the starting station number for the selected survey line. This value is used in conjunction with Station Increment to calculate the current station number for display purposes.

### Stn Increment (station increment)

Activate text box by tapping or using **TAB** key and then enter the desired value for the station increment.

This parameter specifies the station increment for the selected survey line. This value is used in conjunction with Start Station to calculate the current station number for display purposes.

After all the parameters in the Survey Setup dialog are updated tap the button **OK** or press **ENTER** key to accept the displayed settings. The program will return to the Main Screen. Updated settings will be written to the initial file and they will be given as default parameters in the subsequent Survey Setup dialog.

To return to original settings (state before this dialog was selected) tap **Cancel (X)** button or press **Esc** key. All parameters will be reset to initial settings and the program will return to the Main Screen.



### 3. Logger Setup

This option allows you to specify used type of the instrument, antenna size and set several parameters in the logger. The Logger Setup dialog is presented below.

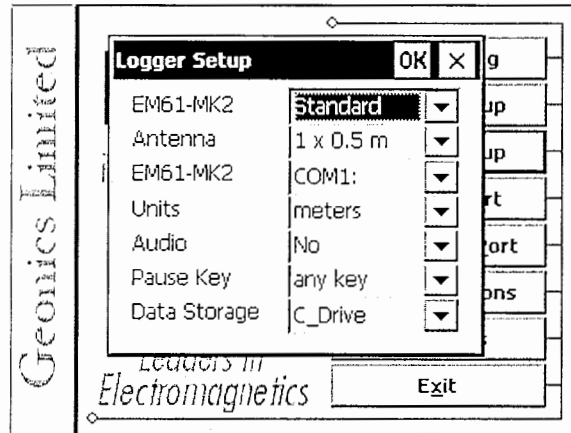

Description of Parameters:

#### EM61-MK2

This option allows you to select type of used instrument. In the drop-down list box select Standard for the EM61-MK2 or High Power if EM61-MK2 High Power (HP) modification is used.

#### Antenna

The Antenna option allows you to select the size of the EM61-MK2 sensor. If the EM61HH-MK2 Hand Held antenna is used this option can be ignored. If the standard antennas are used (1 x 0.5 m, 1 x 1 m, or 0.5 x 0.5 m) the size of the sensor must be specified before monitoring the instrument output. Select proper size of the EM61-MK2 sensor in the drop-down list box labeled Antenna.

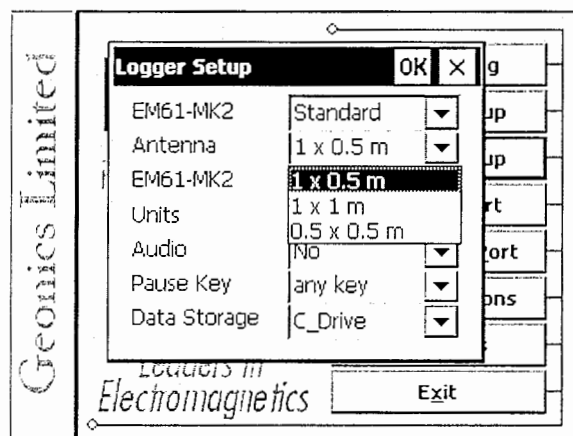

#### EM61 Port

The number of serial port that is assigned to the EM61-MK2. Available selections: COM1, COM2, COM3, and COM4. The program default is COM1. Communication parameters for the selected serial port are set by the program, since the EM61-MK2 operates at fixed settings: Baud Rate (9600), Parity (N), Data Bits (8), and Bit Stop (1).

This port must be different than serial port specified in the Set Port for GPS and Set Output Port options (see later chapter), otherwise a message will be displayed and ports will have to be reassigned.

Select port number in the drop-down list box (see Figure below).

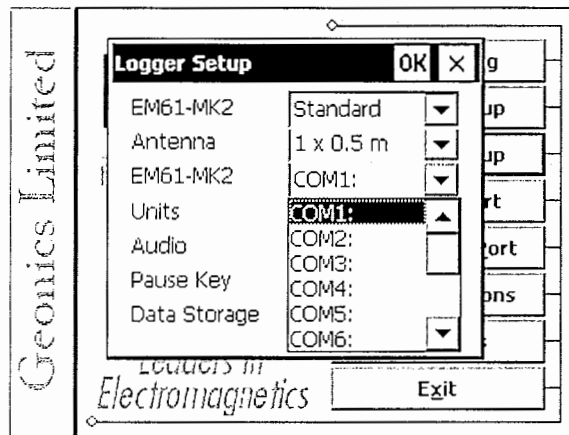

### Units

Two selections are available: **Meters** or **Feet**.

### Audio

Two selections are available: **Yes** or **No**. The audible click will be generated at each reading when this option is enabled. At fast rate (above 5 readings/s) the sound may appear not uniform, however this does not affect quality of data acquisition.

### Pause key

Four selections are available: **any key**, **Space Bar**, **Enter**, and **P**. This feature is used to pause data recording during logging session. Default setting **any key** can be changed to one of the three specific keys for field conditions where a logger key can be accidentally pushed causing unwanted stop of data logging.

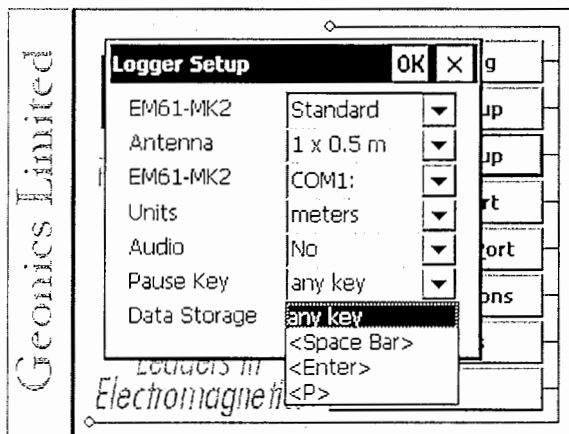

### Data Storage

A tap on the down arrow next to the text box opens a drop-down box showing the available settings, or when the keyboard is used navigate to the text box by TAB key and then by using up or down arrow keys select one of two available options.

Two options are available: **C\_Drive** (default) or **Storage\_Card**. The C\_Drive option will create data files in the built in non volatile memory of the Allegro CX field computer. The Storage\_Card option is available only when PC memory card is inserted in to Allegro CX PCMCIA slot (located behind the display).

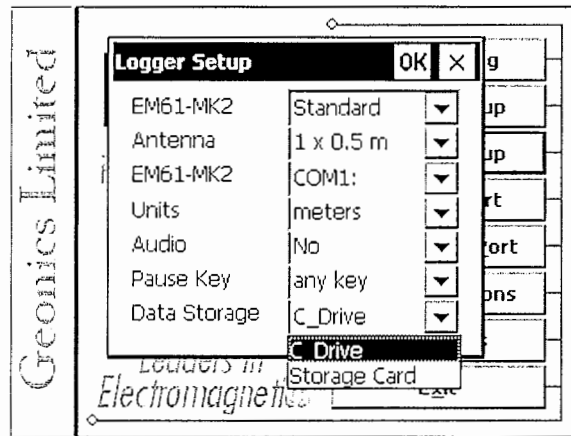

After all the parameters in the Logger Setup dialog are updated tap the button **OK** or press **ENTER** key to accept the displayed settings. The program will return to the Main Screen. Updated settings will be written to the initial file and they will be given as default parameters in the subsequent Logger Setup dialog.

To return to original settings (state before this dialog was selected) tap **Cancel (X)** button or press **Esc** key. All parameters will be reset to initial settings and the program will return to the Main Screen.



## 4. Set Port for GPS

After the Set Port for GPS button was tapped (or executed from the keyboard) in the Main Screen the Set Port for GPS dialog window appears on the screen. This dialog allows you to enable and disable the GPS input, specify serial communication parameters matching GPS receiver settings, and to monitor the GPS output in terminal mode (the bottom button). The dialog is presented below.

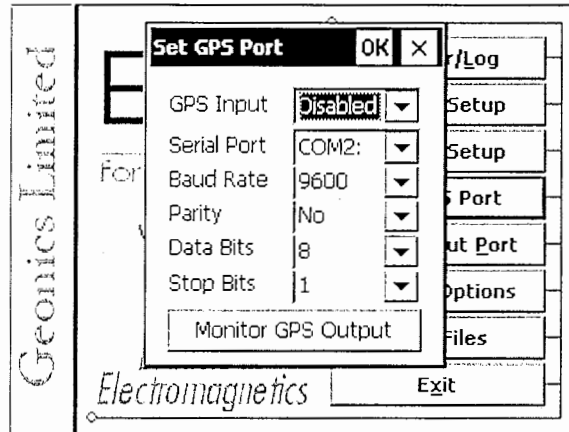

Description of Options and Parameters:

### GPS Input

This option allows you to Enable/Disable a serial port for GPS input. When Disabled is chosen logging and monitoring screens will display message “GPS disabled” in place of GPS parameters.

The GPS Input can be Enabled even if there is no GPS system connected to the Allegro. In such case data file will contain proper sequence of EM61-MK2 readings without any GPS input.

Tapping on the down arrow next to the text box labeled GPS Input opens a drop-down box showing the available settings, or when the keyboard is used activate the text box by pressing TAB key and then by using up or down arrow keys select one of two available items: Enable and Disable.

### Serial Port

The number of serial port that is assigned to the GPS input. Available selections: COM1 to COM12. The program default is COM2. Communication parameters for the selected serial port can be determined in options described below.

This port must be different than the port specified in the Logger Set Up menu (for EM61-MK2) and Set Output Port dialog, otherwise a message will be displayed and ports will have to be reassigned.

Tapping on the down arrow next to the text box labeled Serial Port opens a drop-down box showing the available ports, or when the keyboard is used activate the text box by pressing TAB key and then by using up or down arrow keys select one of available items.

### Baud Rate

Specify Baud Rate for the output port, the selected value should match the Baud Rate of the GPS system, default is 9600. Available settings are: 4800, 9600, 19200, 38400, 57600, and 115200.

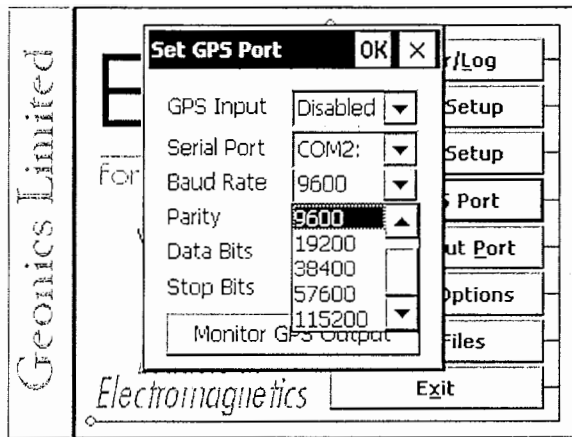

Tapping on the down arrow next to the text box labeled Baud Rate opens a drop-down box showing the available parameters, or when the keyboard is used activate this text box by pressing TAB key and then by using up or down arrow keys select one of available items.

#### Parity

Select Parity for the output port, the parameter should match the Parity set in the GPS serial port settings. Available settings are None, Even, and Odd; default is N.

Tapping on the down arrow next to the text box labeled Parity opens a drop-down box showing the available parameters, or when the keyboard is used activate this text box by pressing TAB key and then by using up or down arrow keys select one of available items.

#### Data Bits

Specify Data Bits for the output port, the selected value should match settings in the GPS receiver, default is 8. Other available selection is 7.

Tapping on the down arrow next to the text box labeled Data Bits opens a drop-down box showing the available parameters, or when the keyboard is used activate this text box by pressing TAB key and then by using up or down arrow keys select one of available items.

#### Stop Bits

Specify Stop Bits for the output port, the selected value should match settings in the GPS receiver, default is 1. Available selections are 1 or 2.

Tapping on the down arrow next to the text box labeled Stop Bits opens a drop-down box showing the available parameters, or when the keyboard is used activate this text box by pressing TAB key and then by using up or down arrow keys select one of available items.

After all the parameters in the Set GPS Port dialog are updated tap the button **OK** or press **ENTER** key to accept the displayed settings. The program will return to the Main Screen. Updated settings will be written to the initial file and they will be given as default parameters in the subsequent Set GPS Port dialog.

To return to original settings (state before this dialog was selected) tap **Cancel (X)** button or press **Esc** key. All parameters will be reset to initial settings and the dialog window will disappear.

To activate terminal mode which allows you to monitor GPS receiver output tap the button labeled Monitor GPS Output, or when using keyboard select this button using **TAB** key and press **ENTER**. The monitoring mode will work regardless of the GPS Input being Enabled or Disabled. This option is described in the following section.



## 4.1 Monitoring GPS Receiver Output

After the button Monitor GPS Output is tapped or executed by the keyboard the program will display the screen in terminal mode. In this mode the screen is divided into three parts. The largest, top portion of the screen displays the GPS receiver output. The middle portion shows that last NMEA command sent to the GPS receiver (by default command shown in Figure below), and at the bottom three buttons representing available options: Pause/Go, Send, and Exit. These buttons can be tapped, executed by TAB key and ENTER keys, or by using shortcuts (pressing underlined letter keys). This screen is shown below.

```
$GPGGA,011627.00,4336.59377,N,07936.64953,W,2,7,1,13
$GPGSA,A,3,30,22,20,25,,14,,05,01,,,,,01.8,01.1,01.4*09
$GPGGA,011628.00,4336.59376,N,07936.64953,W,2,7,1,13
$GPGSA,A,3,30,22,20,25,,14,,05,01,,,,,01.8,01.1,01.4*09
$GPGGA,011629.00,4336.59385,N,07936.64958,W,2,7,1,13
$GPGSA,A,3,30,22,20,25,,14,,05,01,,,,,01.8,01.1,01.4*09
$GPGGA,011630.00,4336.59385,N,07936.64958,W,2,7,1,13
```

```
$PASHS,NME,SAT,A,ON
```

Pause	Send	Exit
-------	------	------

As soon as the EM61MK2 screen is in terminal mode and the GPS is streaming data, each message transmitted by GPS receiver will appear in the top portion of the display (the end may be cut off if an NMEA message is longer than screen). The display is updated with the frequency the GPS receiver outputs data. This allows you to recognize the GPS update rate and type of messages being sent by the connected GPS. In cases where the GPS data is not received by the logger a message NO DATA and current time will appear in the top window of the display, as shown below.

```
NO DATA
NO DATA
NO DATA
NO DATA
NO DATA
```

```
$PASHS,NME,SAT,A,ON
```

Pause	Send	Exit
-------	------	------

The message NO DATA is normally updated with a rate of 7 seconds. This may indicate the following: serial port number not correctly specified in Set Port for GPS dialog, GPS receiver not sending any data, and not working or not connected GPS receiver. If the message is updated more often than 7 seconds (i.e. every 1 or 2 seconds) or the display does not show legible characters, it is possible that the GPS is working correctly and is connected to the proper serial port, however communication parameters are not specified correctly. In most cases the Baud Rate or Parity must be adjusted.

The NO DATA message may also appear if the GPS data are received correctly, but the GPS receiver was set to send data with a time interval longer than 7 seconds. In this case the NO DATA message will be displayed in between GPS messages. This indicates that the GPS is working correctly, however the operator should consider adjustment of the GPS receiver output update rate. Most high resolution geophysical surveys require positioning update of 1 or 2 seconds, and a 5 seconds interval can be used only when the survey is carried out at an even pace and along relatively straight survey lines.

The monitoring display can be stopped any time by using button labeled **Pause**. At that time scrolling of the GPS output will be stopped, and the button will be labeled **Go**. The next tap (or keyboard action) on this button will activate receiving and display of GPS data.

The button labeled **Send** allows you to send a NMEA command to the GPS receiver. It is preferable if the GPS receiver parameters are set using the GPS manufacturer software or controller (GPS logger or panel keys). However, **when the operator is familiar with NMEA protocol and structure of commands for a given GPS system**, this function can be very convenient and useful when the update rate and enabling or disabling messages in the data stream is required.

After the button **Send** is tapped a dialog titled GPS Message is displayed and the beginning of the standard NMEA command, **\$PASHS**, or the last entered command is displayed. After the entire NMEA command is typed in, tap **OK** button or press the key <ENTER> to send the command to the GPS receiver. Tapping **Cancel** button or pressing the <Esc> key will cancel the command and hide the NMEA Message dialog. An example of a command that will enable the NMEA message **SAT** is given in the below figure (it is assumed that the GPS receiver output serial port is A).

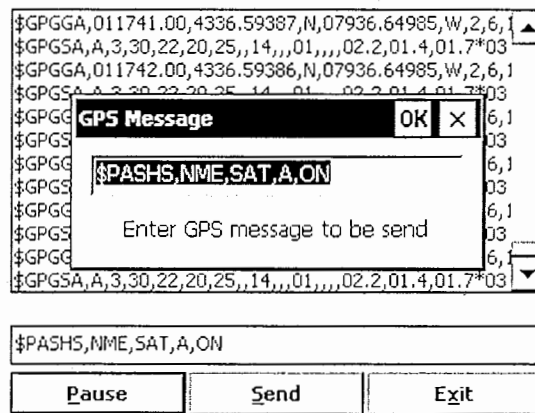

After this command is received by the GPS receiver, the confirmation message will be send by the receiver (\$PASHR, ACK\*3D) and data stream will contain the message SAT (\$PASHR, SAT,.... in the above figure).

Please note, that not every GPS system accepts and uses the same standard set of NMEA commands and messages. In addition, some GPS systems do not accept commands sent by the serial port at all. The configuration of these type of receivers can be updated only by the controlling device (usually GPS logger, controller, or the receiver panel keys).

## 5. Set Output Port

This option is used to enable simultaneous output of data collected through a selected serial port. Data can be sent to other logging devices, including remote computers connected by wireless modem or digital radio. EM61-MK2 data and optional GPS stream is sent by the Allegro serial port output only during Logging session when readings are written to a data file.

After the Set Output Port button is tapped (or executed from the keyboard) in the Main Screen the Set Output Port dialog window appears on the screen. This dialog allows you to enable and disable the output, specify format of output, and specify serial communication parameters matching external device settings. The dialog is presented below.

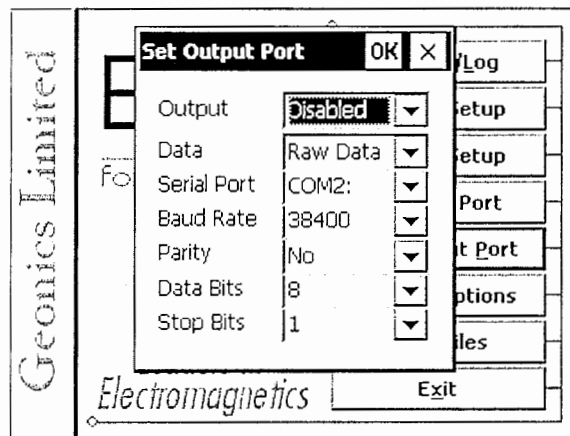

Description of Options and Parameters:

### Output

This option allows you to Enable/Disable a serial port data output. The Output can be Enabled even if there is no receiving device connected to the Allegro.

Tapping on the down arrow next to the text box labeled GPS Input opens a drop-down box showing the available settings, or when the keyboard is used activate the text box by pressing TAB key and then by using up or down arrow keys select one of the two available items: Enable and Disable.

### Format

This option allows you to specify the format of the output string: Raw Data or Converted. The Raw Data format indicates that the string will be sent in binary format (24 bytes long records) and the format is exactly the same as the raw data file format (R61) described in Appendix A. All GPS messages are broken to 24 bytes long records as described in Appendix A. Data files collected with an external device may be converted to ASCII format (assuming the entire data set was collected) using the option Convert in the data processing program DAT61MK2.

If Converted is selected then the string sent by the output serial port will contain converted data in mV and GPS NMEA message will be sent as it is received from the employed GPS receiver. The converted format also includes station number according to start station and increment specified in corresponding dialogs, and a time stamp in milliseconds for each reading. An example of the output data format is shown in Appendix B.

The Raw Data format is preferable since it is more than three times smaller.

## Serial Port

The number of serial port that is assigned to the GPS input. Available selections: COM1 to COM12. The program default is COM2. Communication parameters for the selected serial port can be determined in options described below.

This port must be different than ports specified in the Logger Set Up (for EM61-MK2) and GPS Port Setup dialogs, otherwise a message will be displayed and ports will have to be reassigned.

Tapping on the down arrow next to the text box labeled Serial Port opens a drop-down box showing the available ports, or when the keyboard is used activate the text box by pressing TAB key and then by using up or down arrow keys select one of available items.

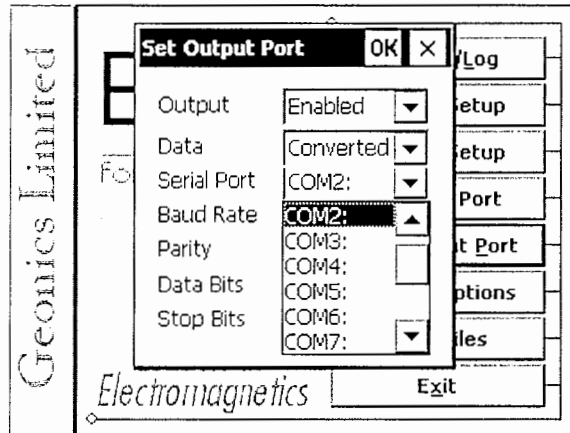

## Baud Rate

Specify Baud Rate for the output port, the selected value should match the Baud Rate of the external device, default is 9600. Available settings are: 4800, 9600, 19200, 38400, 57600, and 115200.

Tapping on the down arrow next to the text box labeled Baud Rate opens a drop-down box showing the available parameters, or when the keyboard is used activate this text box by pressing TAB key and then by using up or down arrow keys select one of available items.

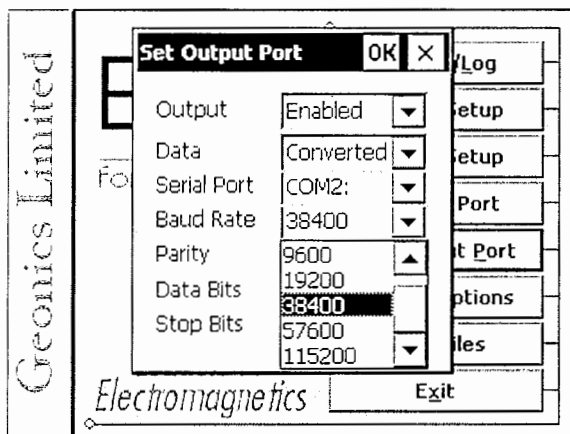

## Parity

Select Parity for the output port, the parameter should match the Parity set in the external device. Available settings are None, Even, and Odd; default is N.

Tapping on the down arrow next to the text box labeled Parity opens a drop-down box

showing the available parameters, or when the keyboard is used activate this text box by pressing TAB key and then by using up or down arrow keys select one of available items.

#### **Data Bits**

Specify Data Bits for the output port, the selected value should match settings in the receiving device, default is 8. Other available selection is 7.

Tapping on the down arrow next to the text box labeled Data Bits opens a drop-down box showing the available parameters, or when the keyboard is used activate this text box by pressing TAB key and then by using up or down arrow keys select one of available items.

#### **Stop Bits**

Specify Stop Bits for the output port, the selected value should match settings in the external device, default is 1. Available selections are 1 or 2.

Tapping on the down arrow next to the text box labeled Stop Bits opens a drop-down box showing the available parameters, or when the keyboard is used activate this text box by pressing TAB key and then by using up or down arrow keys select one of available items.

After all the parameters in the Set Output Port dialog are updated tap the button **OK** or press **ENTER** key to accept the displayed settings. The program will return to the Main Screen. Updated settings will be written to the initial file and they will be given as default parameters in the subsequent Set Output Port dialog.

To return to original settings (state before this dialog was selected) tap **Cancel (X)** button or press **Esc** key. All parameters will be reset to initial settings and the dialog window will disappear.



## 6. Display Options

After the **Display Options** button was tapped (or executed from the keyboard) in the Main Screen the Display Options dialog window appears on the screen. This dialog allows you to enable and disable the display of each channel profile, specify color and thickness of profiles, and select linear or compressed amplitude for profiles. The dialog is presented below.

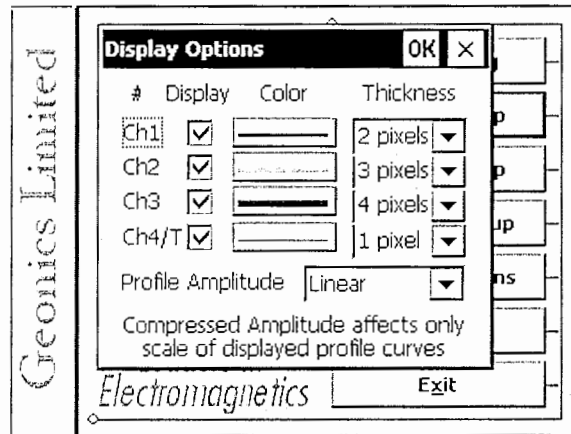

Description of Options and Parameters:

### Display

To enable or disable displaying of each channel profile tap on the corresponding button labeled Display. Profiles of all channels with checked buttons will be displayed during data logging.

Regardless of which channels are chosen to be displayed as profiles, data for all four channels will be displayed in numeric form below profile display.

### Color

To change colour of each profile tap the corresponding button (with colour line) labeled Color. The following dialog titled Color will appear.

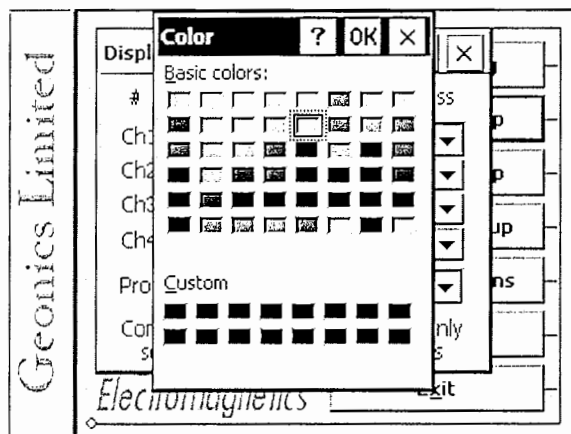

Select desired colour by tapping on a colour box (the selected colour box will be highlighted).

Tap the button **OK** or press **ENTER** key to accept the highlighted colour. The Color dialog will disappear and the colour of the appropriate channel button will updated. To cancel colour selection tap **Cancel (X)** button or press **Esc** key.

### Thickness

Specify thickness of a profile for a desired channel by using one of four drop-down boxes labeled thickness. Thickness of a profile curve is expressed in pixels. Available settings are: 1, 2, 3, or 4 pixels.

Tapping on the down arrow next to the text box (labeled by number of pixels) opens a drop-down box showing available selection (see Figure below). Select thickness by tapping on the desired selection. If keyboard is used activate text box by pressing TAB key (till the box is highlighted) and then by using up or down arrow keys select one of available items.

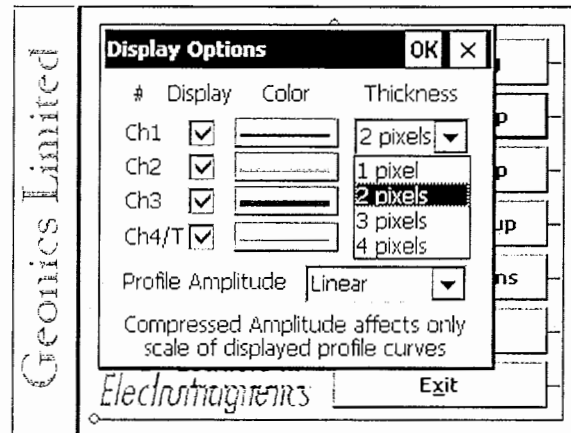

### Profile Amplitude

This option allows you to select Linear or Compressed amplitude scale for profiles. The compressed amplitude (square root function) allows you to display the high dynamic range of the EM61-MK2 data in a legible way and it is recommended.

Tapping on the down arrow next to the text box labeled Profile Amplitude opens a drop-down box showing available parameters, or when keyboard is used activate this text box by pressing TAB key and then by using up or down arrow keys select one of available items.

**Please note, that readings in numeric form are always given in mV (linear scale) regardless of the Profile Amplitude selection. Further, graphic display in the compressed scale does not affect readings saved in the data file. Data are always written to file in original form.**

After all the parameters in the Display Options dialog are updated tap button **OK** or press **ENTER** key to accept the displayed settings. The program will return to the Main Screen. Updated settings will be written to the initial file and they will be given as default parameters in the subsequent Survey Setup dialog.

To return to original settings (state before this dialog was selected) tap **Cancel (X)** button or press **Esc** key. All parameters will be reset to initial settings and the dialog window will disappear.



## 7. Logging Data

After the **Monitor/Log** button (in Main Screen) is tapped or executed by the keyboard, the program enters logging session which contains three modes: Monitoring, Stand By and Logging. Program starts logging session always in Monitoring mode. In this mode EM61-MK2 readings and GPS

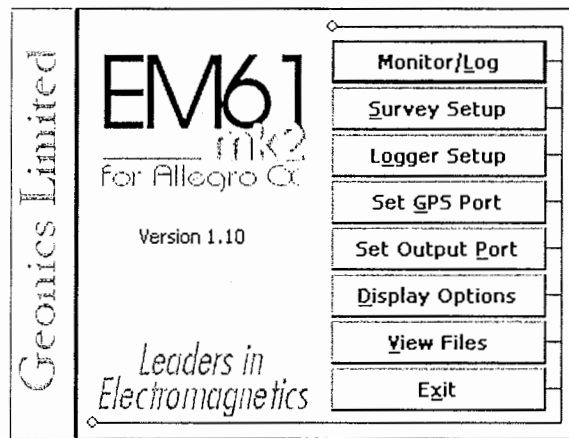

parameters can be quickly examined and some functions (creating data file, nuling, QC coil check) can be performed. After a data file is created in Monitoring mode, the program switches to Stand By mode and allows access to Logging mode. In Stand By mode instrument output can be monitored and some survey and logging parameters can be changed, and Logging mode is used only to record data. Two modes Stand By and Logging are toggled by **GO** and **Pause** buttons.

### 7.1 Monitoring Mode

The Monitor mode allows initial inspection of the range of the instrument readings at a particular site, monitoring the instrument performance, quick inspection of the condition of the instrument battery, perform QC Coil check, and setting zero level of the instrument.

It is assumed that the instrument is turned ON prior to using this option. If the instrument is OFF or the instrument console is not connected to the computer the following message will appear:

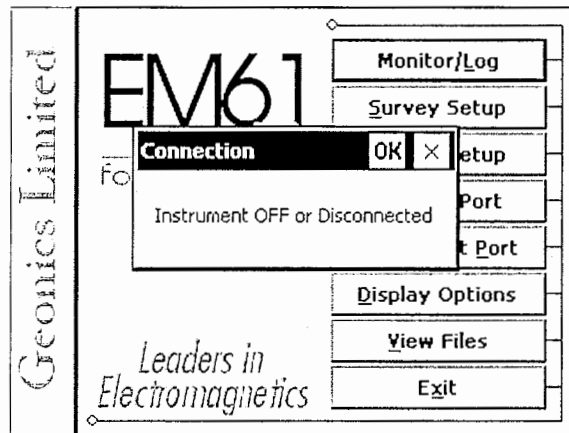

Check the connection or turn the instrument ON and select the Monitor/Log option again.

Assuming that the instrument works properly the program will display the Monitor mode window and will start normalization session which lasts less than 10 seconds. At this stage the Monitor window will display the following message:

After the normalization is finished the layout of the Monitor window is as follows:

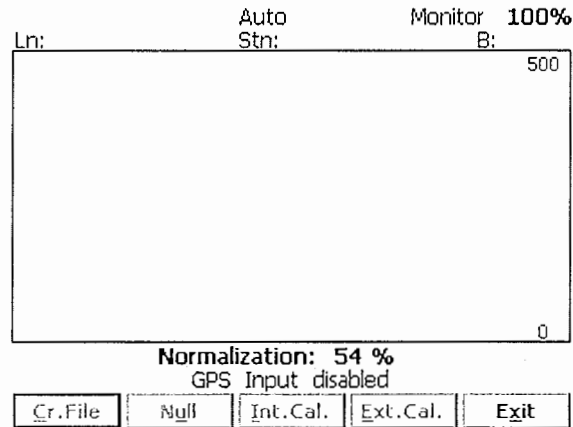

The Monitor (as well as Stand by and Logging) window is divided into four sections.

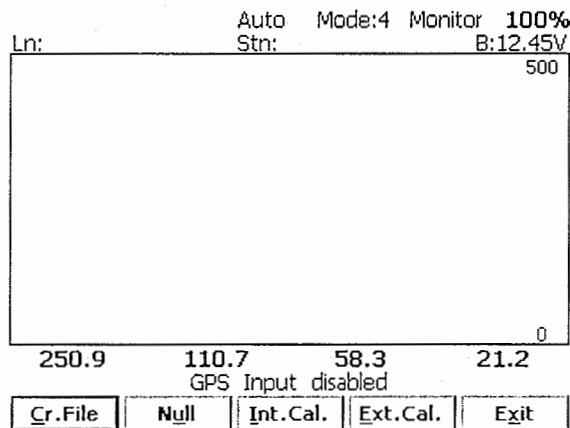

Two lines of text in the top section provides survey parameters (used in Stand By and Logging modes) and instrument information. In Monitor mode this section displays: instrument mode (4 or D), current display mode (Monitor, Stand By or Logging), Allegro battery level (in % of full charge), and the EM61-MK2 battery level in Volts (following label **B:**). When fiducial marker is pressed then **M** is displayed next to label **Stn:**.

The second, largest graphic section will be used to display profiles during logging data.

The third section contains two lines of text. The first line is used to display EM61-MK2 readings and the second line of text provides GPS related information.

If Mode 4 was selected on the instrument panel (it is displayed at the top of the screen) channels 1, 2, 3, and 4 will be displayed under profile window, and when Mode D was selected (for Top and Bottom antennas) channels 1, 2, 3, and T will be given in the Monitoring window. Channels are not labeled and they are displayed from the left in ascending order: 1, 2, 3, and 4, or 1, 2, 3, and T. The EM61-MK2 readings are updated approximately 10 times per second during the monitoring session.

When GPS was Disabled in the Set GPS Port dialog a message **GPS Input: disabled** will be displayed. If the GPS port is Enabled and a working GPS receiver is connected to the field computer the Monitoring screen will display GPS parameters, as presented below.

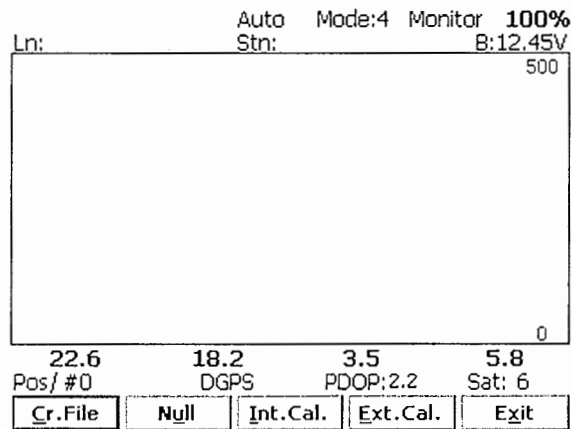

In the above Figure one line of the display is dedicated to show the GPS status. A label **Pos/#** will be used during data acquisition, it will provide the number of GPS positions saved in the data file. In Monitor mode this label indicates GPS activity by toggling between forward (/) and back (\) slash (that follows label **Pos**) every time the program receives a message from the GPS receiver. If the slash is not changing for long periods of time it means that the GPS receiver is not working or that it is not connected to the field computer. A label **DGPS** (Differential Global Positioning System) indicates that GPS readings are differentially corrected in real time, while label **AGPS** (Autonomous Global Positioning System) indicates lack of differential correction. The next label **PDOP** with a value varying between 0 and 99.9 represents an index called Position Dilution of Precision (**PDOP**). This value is available only when messages both, GGA and GSA are received from GPS. The last label **Sat** and following number shows number of currently tracked satellites. Refer to section 9 (Set Port for GPS), Appendix A, and to GPS manuals for more information about GPS parameters.

The fourth section of the Monitor window lists the program functions available directly in the Monitor mode given at the bottom of the screen in form of buttons. Available options are as follows: **Cr.File** - create data file, **Null** - Nulling, **Int.Cal.** - Internal QC-coil calibration, **Ext.Cal.** - External QC-coil calibration, **Exit** - exits the Monitor mode and returns program to Main Screen.

## Description of Monitoring Mode Options

### **Cr.File** (*create data file*)

When a data file is created the program will switch to Stand By mode automatically.

The log file can be created in the given default directory (DAT61MK2) or in any other directory in the Allegro CX. If other directories are used, please note that only subdirectories of C\_Drive represent save, non volatile memory.

The name of the file is given by the field computer clock and it consists of month (2 digits), day (2 digits), hour (2 digits), and one alphabetic character A, B, C, etc. (If all letters during one hour are used use the Overwrite option). The Create Data File dialog is presented below.

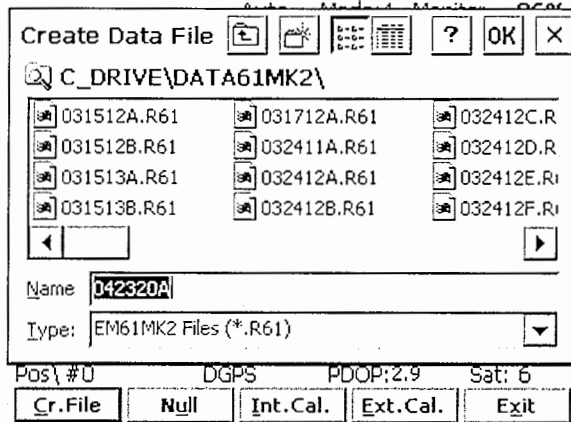

The file name can be specified in the Create Data File dialog using the Windows standard interface procedure. The EM61-MK2 data files cannot be appended.

Each data file in the field computer (raw data file) has an extension name R61 and it is created in the directory specified in Create Data File dialog. The R61 files are created in the instrument binary format. They can be viewed using the Main Screen option "View Files". These files can be also converted to ASCII format and processed in the Geonics DAT61MK2 program.

After the file is specified tap the button **OK** or press **ENTER** key to accept and create data file. The program will switch Monitor mode to Stand By mode and the data file will be displayed on the screen.

To cancel selection and return to Monitoring mode tap the **Cancel (X)** button or press **Esc** key.

## Null

To perform a null of the instrument tap the button labeled **Null** or execute this option using the keyboard (navigate to the button by pressing **TAB** key and when highlighted press **ENTER** key, or use shortcut - press key **U**). At this moment the computer takes 50 readings and calculates the instrument offset.

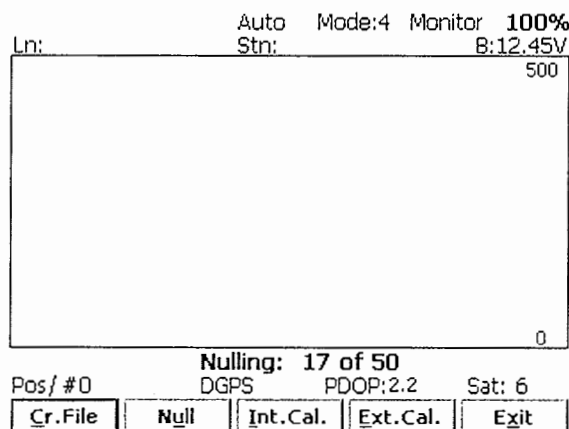

The calculated offset is applied to all the readings that follow this operation. If needed, this procedure can be repeated several times until satisfactory results are obtained. However, there is no associated "Undo" function. If original values (without calculated offsets) of the EM61-MK2 readings are needed, exit the EM61MK2 program and run it again. The EM61-MK2 instrument does not have to be turned OFF. Null operation can be also performed later during data collection.

### Int.Cal. (Internal QC Coil Calibration)

The Internal QC coil calibration is described in detail in the EM61-MK2 Operating Instructions.

To start the calibration using Internal QC coil tap the key labeled **Int.Cal.** or execute this option by keyboard (navigate to the button by pressing **TAB** key and when highlighted press **ENTER** key, or use shortcut - press key **I**). This action begins by performing the automatic nulling which in this case is only in effect for the duration of the calibration process. It will not affect EM61-MK2 readings. After the nulling is completed (less than 5 seconds) the Internal QC coil Calibration window is displayed.

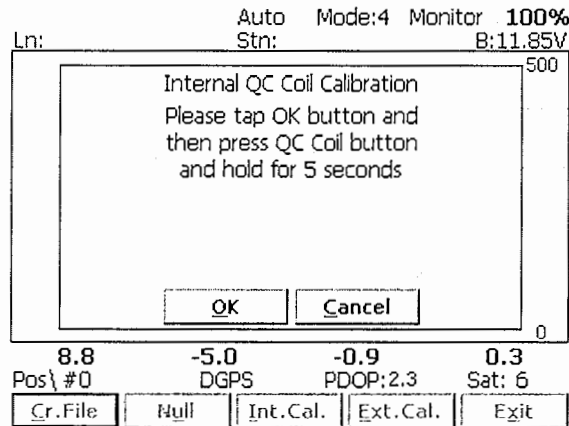

After **OK** button is tapped (or shortcut key **O** is pressed) the window displays timer with elapsed seconds and EM61-MK2 readings. This display lasts for 60 seconds. During this time please follow the instructions provided on the Allegro screen.

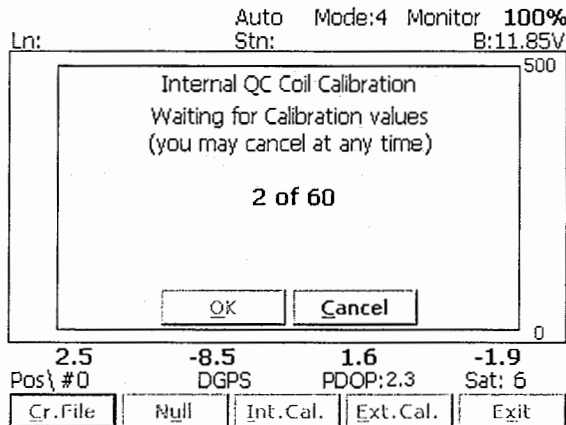

Internal QC coil calibration can end in the following four ways:

The process can be stopped by an operator at any time by tapping **Cancel** button or pressing shortcut key **C**.

The calibration may end by time out (60 seconds) if QC coil button was not pressed or this action did not activate QC coil. The following screen will then be displayed:

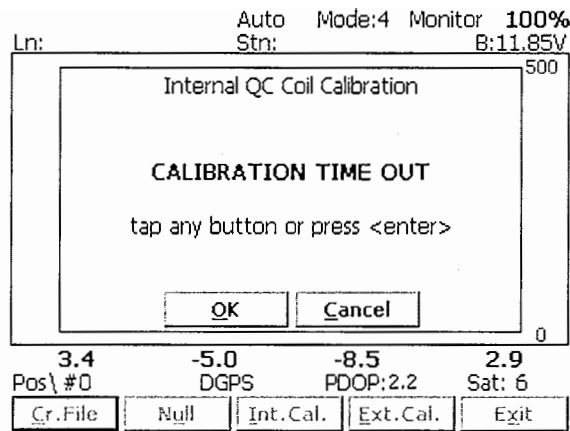

After pressing any key the program returns to Monitoring window. To repeat Internal QC coil calibration please tap the **Int.Cal.** button again.

The logger will determine if the instrument has passed test. If after activating the QC coil, the program determines that the reading is inside the standard values within +/- 10% tolerances then a message "CALIBRATION OK" will be displayed (see below).

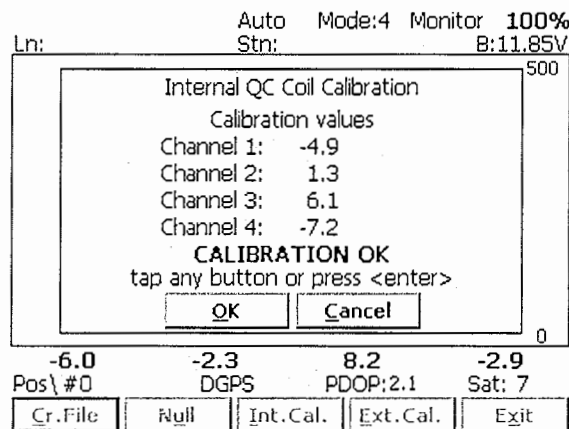

Otherwise, if the program determines that the reading is outside of the test values range the corresponding message "CALIBRATION FAILED" is displayed.

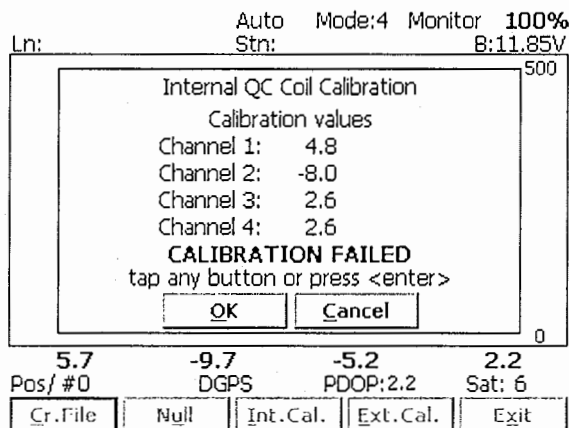

Regardless of the test result (OK or FAILED) the readings will be saved on screen. The program returns to Monitoring window after any button is tapped or ENTER key is pressed. Then the Internal QC coil calibration process can be repeated.

## External QC Coil Calibration

The External QC coil calibration is described in detail in the EM61-MK2 Operating Instructions.

To start the calibration using the Internal QC coil tap the button labeled **Ext.Cal.** or execute this option by keyboard (navigate to the button by pressing **TAB** key and when highlighted press **ENTER** key, or use shortcut - press key **E**). This action begins by performing the automatic nulling which in this case is only in effect for the duration of the calibration process. It will not affect EM61-MK2 readings. After the nulling is completed (less than 5 seconds) the External QC coil Calibration window is displayed.

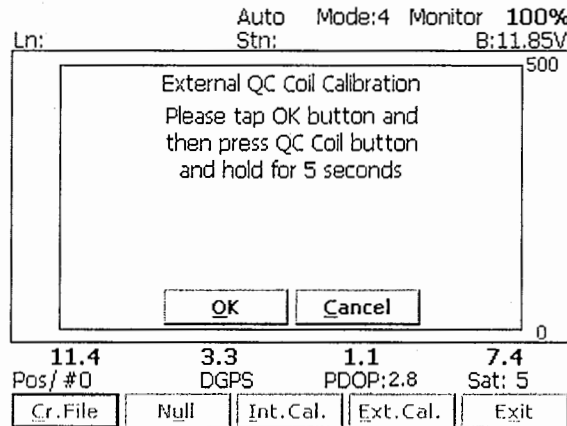

After **OK** button is tapped (or shortcut key **O** is pressed) the window displays timer with elapsed seconds and EM61-MK2 readings. This display lasts for 60 seconds. During this time please follow the instructions provided on the Allegro screen.

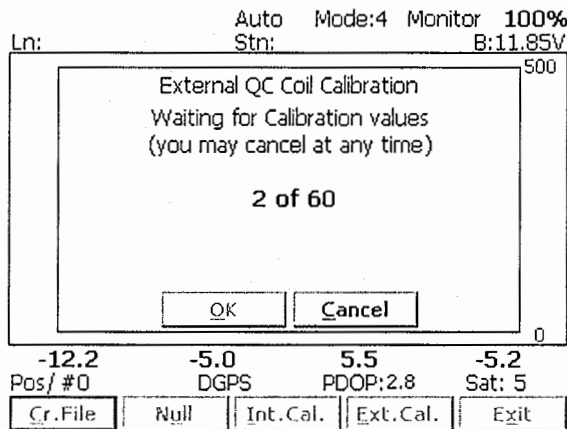

External QC coil calibration can end in the following four ways:

The process can be stopped by an operator at any time by tapping **Cancel** button or pressing shortcut key **C**.

The calibration may end by time out (60 seconds) if the External QC coil button was not pressed or this action did not activate QC coil. The following window will then be displayed (see below).

After pressing any key the program returns to Monitoring window. To repeat External QC coil calibration please tap the **Int.Cal.** button again.

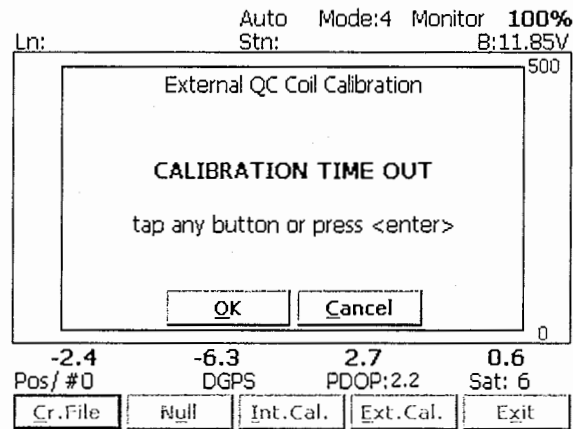

The logger will determine if the instrument has passed test. If after activating the QC coil, the program determines that the reading is inside the standard values within +/- 10% tolerances then a message "CALIBRATION OK" will be displayed.

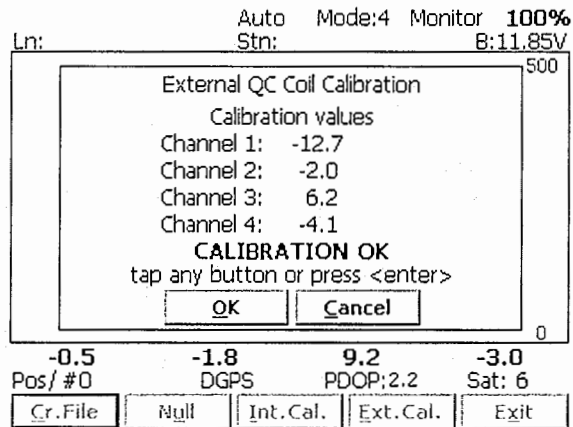

Otherwise, if the program determines that the reading is outside of the test values range the corresponding message "CALIBRATION FAILED" is displayed.

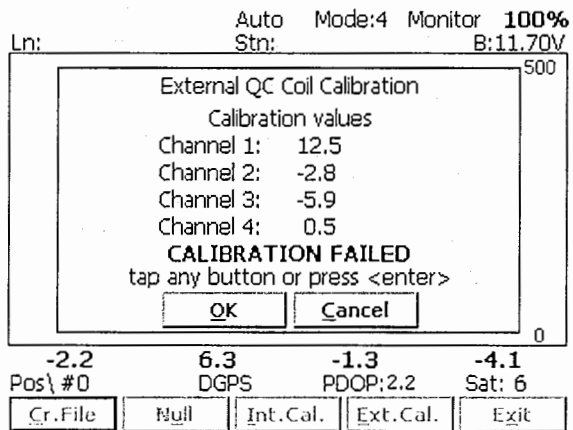

Regardless of the test result (OK or FAILED) the readings will be saved on screen. The program returns to Monitoring window after any button is tapped or ENTER key is pressed. Then the Internal QC coil calibration process can be repeated.

#### Exit (exit Monitor mode)

After tapping Exit button (or executing this option using keyboard) the program immediately returns to Main Screen.



## 7.2 Stand By Mode

After data file is created in Monitoring mode the program automatically switches logging window to Stand By mode. This window is similar to Monitor mode however it contains survey parameters (file name, survey line name, etc.) and different set of options represented by buttons displayed at the bottom of the screen. The logging window in Stand By mode in initial state (before any data is recorded) is presented below.

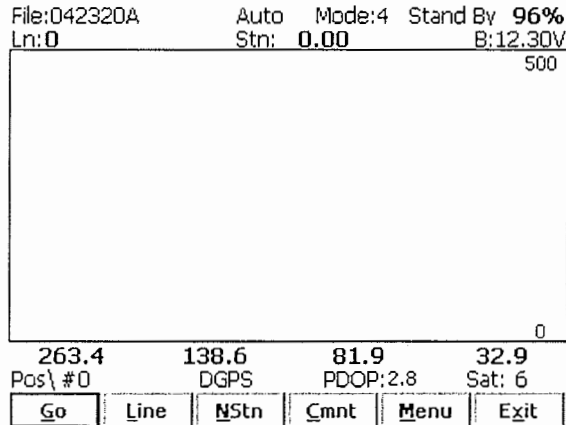

The main portion of the screen is occupied by the plot area which displays profiles (see Figure below which shows Stand By mode after some data were collected). Readings in the plot area can be displayed in compressed amplitude scale, which corresponds to Square Root of the amplitude. In compressed amplitude scale 0 to 100 corresponds to 0 to 10,000 mV, and compressed range 0 to 200 corresponds to 0 to 40,000 mV. Plotting data in compressed amplitude allows you to show details in the low range of amplitude, as well as relatively good resolution in the high range of data on the small screen. **Please note, that data displayed in the numeric form are always given in the standard, linear scale.** The amplitude scale is divided by four or five grey grid lines. In the case where the amplitude scale starts with a negative value, then the grid line corresponding to zero is always plotted as a thicker line.

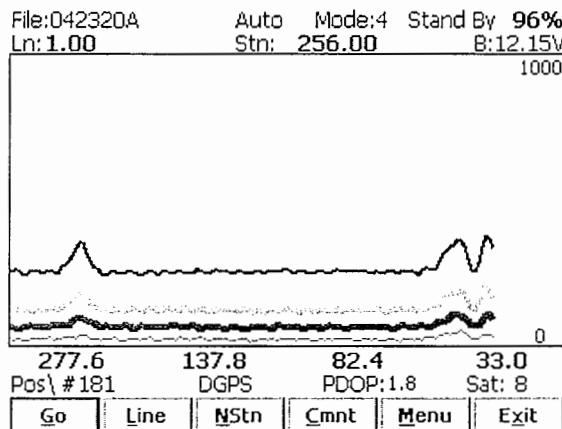

Readings for channels 1, 2, 3, and 4 (or T) are shown in numeric form below the plot area. Channel labels are not displayed due to the small screen of the Allegro. Values of readings are displayed in the following order (from the left): Channel 1, 2, 3, and 4 (or T). EM61-MK2 readings (in numeric form) are updated in Stand By mode approximately 10 times per second. Profiles in the plot area are updated only during Logging mode when data are actually saved in the data file.

A section of the window at the top of the screen contains two lines of text displaying survey and instrument related parameters. These are (from top left): current data file name (labeled **File:**), survey mode (**Auto**, **Wheel** or **Manual**), instrument mode **4** or **D** (labeled Mode:)), logging mode **Stand By** or **Logging**), Allegro internal battery level (in % of full charge, not labeled), current survey line (labeled **Ln:**), current station (labeled **Stn:**), and EM61-MK2 battery level in Volts (labeled **B:**). When fiducial marker is active a label **M** is displayed between station label and station value.

In the Stand By mode the station number will not change. Stations in the EM61MK2 program are incremented by station increment value after each reading is written to the data file.

One line of the display is dedicated to showing the GPS status. A number following the label **Pos/#** provides the number of GPS positions saved in the current data file. In Stand By mode the number of positions is not incremented (it is updated only when GPS position is written to the file). However this label indicates GPS activity by toggling between forward (/) and back (\) slash (that follows label **Pos**) every time the program receives a message from GPS receiver. If the slash is not changing for long periods of time (larger than GPS receiver update rate) it means that the GPS receiver is not working or that it is not connected to the field computer. A label **DGPS** (Differential Global Positioning System) indicates that GPS readings are differentially corrected in real time, while label **AGPS** (Autonomous Global Positioning System) indicates lack of differential correction. The next label **PDOP** with a value varying between 0 and 99.9 represents an index called Position Dilution of Precision (**PDOP**). This value is available only when messages both, GGA and GSA are received from GPS. The last label **Sat** and following number shows number of currently tracked satellites. Refer to section 4 (Set Port for GPS), Appendix A, and to GPS manuals for more information about GPS parameters.

Several available field options are listed at the bottom (in form of buttons) of the Stand By mode window. They will be described in the following section 6.4.

## 7.3 Logging Mode

The Logging mode is enabled by tapping on the **GO** button or pressing the shortcut key **G** (or the **<ENTER>** key if button **GO** is highlighted) in Stand By mode. After this button is pressed the list of buttons at bottom of the screen will be replaced by one "Pause" button, label Stand By will be replaced by label **Logging** (at the top of the display) and data will be logged in the mode corresponding to the selected EM61-MK2 mode in the Survey Setup menu. All labels and parameters (with the exception of buttons representing Stand By mode options) are the same as in Stand By mode and they are described in the preceding section 6.2. The screen in Logging mode is presented below.

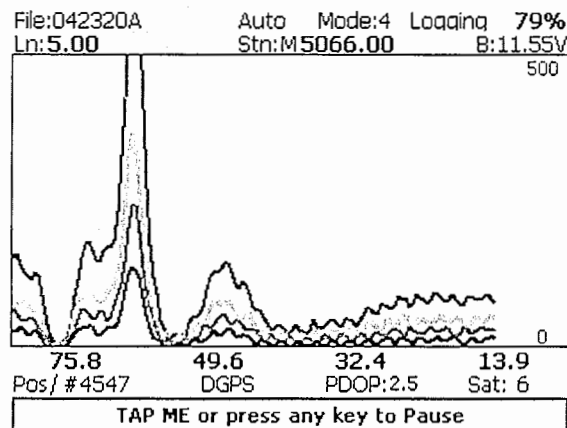

After the screen changes to Logging mode the current station (label **Stn:**) is updated according to the station interval. Similarly, if GPS Input was enabled, total number of GPS positions (label **Pos**) in the data file is incremented every time (usually once a second) GPS position is written to the file. Profile curves (for channels selected in Display Options window) are updated after each reading is written to the data file.

There is only one option available in the Logging mode - pause logging. After a Pause button is tapped or Pause key (any key or other Pause Key selected in Logger Setup window) is pressed the recording is stopped and the Logging mode returns to the Stand By mode. In Stand By mode the EM61-MK2 data will be displayed with the update rate approximately 10 readings per second, however data will not be saved in the log file and profile curves will be not updated.

Exit from the logging session and access to field options are available only from the logging window in Stand By mode.

## 7.4 Stand By Mode Field Options

Several field options are available while the Logging window is in the Stand By mode. More frequently used options can be accessed directly from command buttons and others can be used from pop up menu activated by button **Menu** (displayed below). Command buttons can be used by tapping on the desired button, or from the keyboard by pressing one of the shortcut keys (underlined characters on button labels) or by navigating using <TAB> key (sets button as a default button - default button is highlighted) and pressing <ENTER> key.

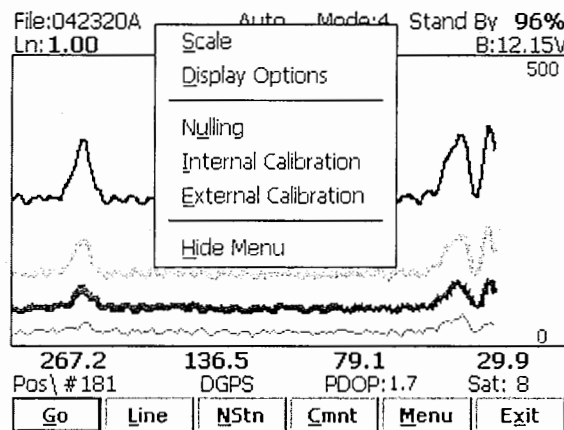

Options listed in the menu can be accessed directly (without displaying pop up menu from Menu button) by using keyboard shortcuts, i.e. pressing key S will display Scale dialog. While menu is displayed options can be selected by tapping on the appropriate proper option, or from the keyboard by pressing the shortcut keys or by navigating using <Up> and <Down> arrow keys and executing by <ENTER>

### GO (start data logging)

Tap on the **GO** button, or while using the keyboard press shortcut key <G> or if the button is a default button (highlighted) press <ENTER>. The logging window in Stand By mode will change to Logging mode and logging data starts immediately.

### Line (New Survey Line)

The New Line dialog is displayed (see Figure below). Selecting this option allows the operator to enter a new survey line number (name) and associated line parameters (Line Increment, Line Sequence, Direction, Start Station, and Station Increment). The new line number and associated parameters are prompted by the program based on parameters specified in the Survey Setup menu.

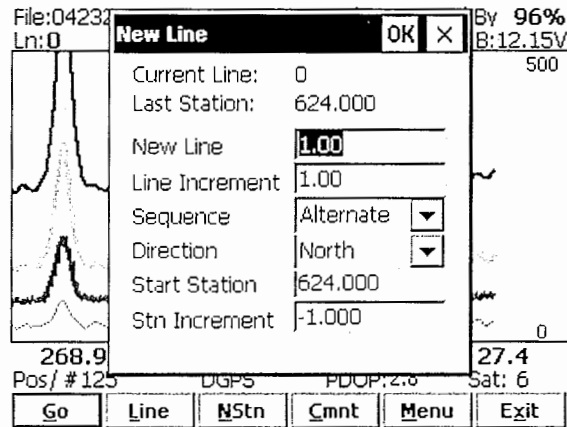

At the top of the dialog the last survey line name and the last logged station are displayed. Default name for the new line is given based on the Line Increment parameter. The default Start Station, direction of the Station Increment, and Direction are determined based on Sequence selection. All these parameters can be overwritten by the user as described in the Survey Setup menu description (chapter 2).

After all the parameters in the New Line dialog are updated tap the button **OK** or press **ENTER** key to accept the displayed settings. The program will return to the Logging window in Stand By mode. Survey line (**Ln:**) name and current station (**Stn:**) value will be updated and profile curves plot for former survey line will disappear.

To return to Stand By mode and current survey line settings (state before this dialog was selected) tap **Cancel (X)** button or press **Esc** key, the dialog window will disappear.

### NStn (New Station)

Selecting this option allows the operator to enter a new station number (within the same survey line). The New Station dialog is displayed.

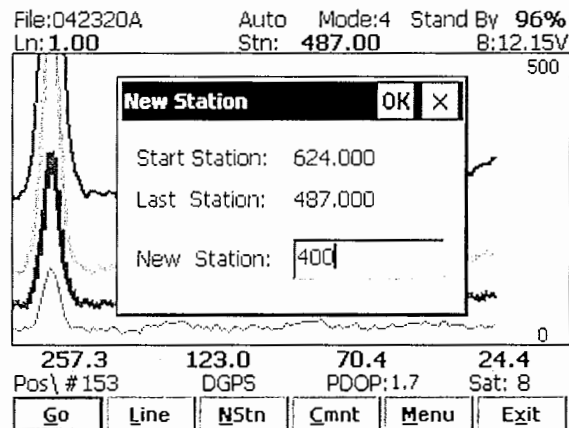

Start and Current station are displayed at the top of the dialog. The New Station can be entered in the provided edit box labeled New Station.

Tap the button **OK** or press **ENTER** key to accept the new value. The program will return to the Logging window in Stand By mode. Current station (**Stn:**) value will be updated and after data logging is activated the profile curves will have a small gap (two pixels) showing the new station entry (see Figure below).

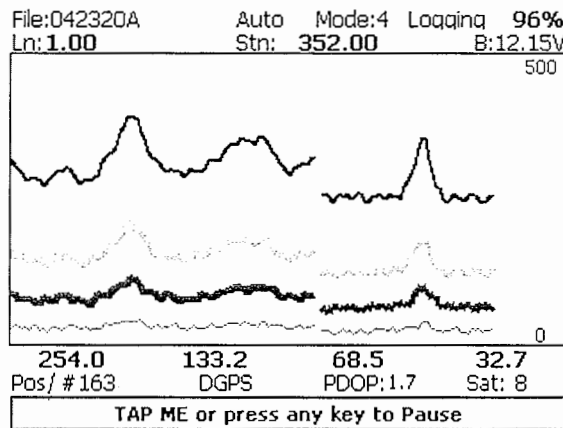

To return to Stand By mode and current survey line settings (state before this dialog was selected) tap **Cancel (X)** button or press **Esc** key, the dialog window will disappear and measurements can be continued.

#### Cmnt (*Comment*)

Selecting this option allows the operator to enter a comment at any point of the survey. A maximum of 11 characters can be entered as a comment. The Enter Comment dialog is displayed.

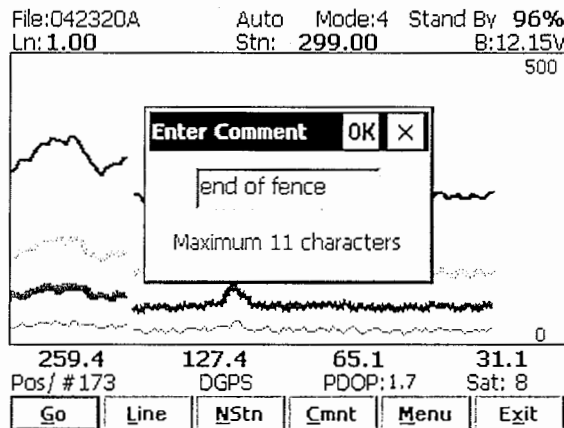

Tap the button **OK** or press **ENTER** key to accept the comment entered in a text box of the dialog. The text of the comment is saved in the file with a corresponding time stamp and the program will return to the Logging window in Stand By mode.

To ignore an entry and return to Stand By mode tap **Cancel (X)** button or press **Esc** key, the dialog window will disappear and measurements can be continued.

### Scale (New Scale for Profile Plot)

Selecting New Scale option allows the operator to enter new scale parameters for the profile plot. This option is available only from pop up menu (accessible from **Menu** button) or directly from keyboard by using shortcut key <S>.

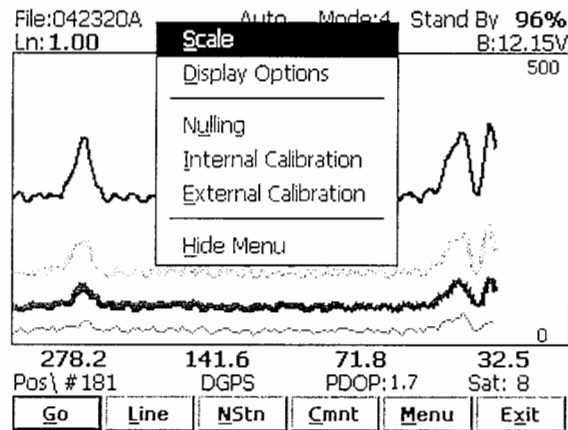

The Enter Scale dialog will be displayed. It contains two text boxes for Minimum and Maximum values of a new scale for profile plot. Current settings (minimum and maximum values) for the scale are displayed in the bottom right and top right corners of the plot area.

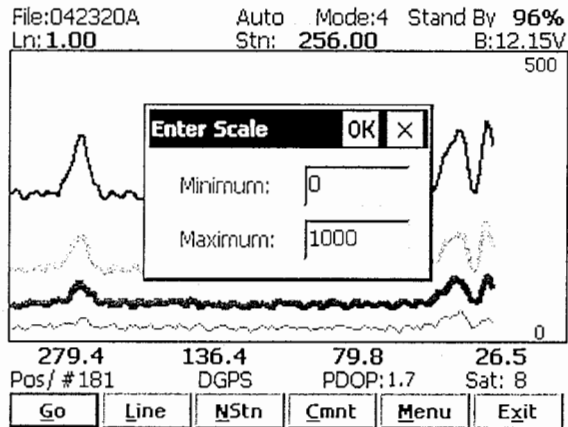

After minimum and maximum values are specified tap the button **OK** or press **ENTER** key to accept to accept new values and the profile plot area will be redrawn (see Figure below).

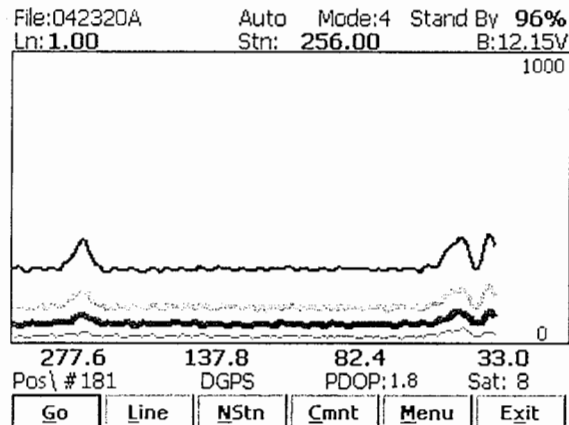

To ignore an entry and return to Stand By mode tap the **Cancel (X)** button or press **Esc** key, the dialog window will disappear and measurements can be continued.

### Display Options *(new options for profile plot display)*

This option is available only from pop up menu (accessible from **Menu** button) or directly from keyboard by using shortcut key <D>.

After the **Display Options** item was selected in the pop up menu the Display Options dialog window appears on the screen. This dialog allows you to enable and disable the display of each channel profile, specify color and thickness of profiles, and select linear or compressed amplitude for profiles. The dialog is presented below.

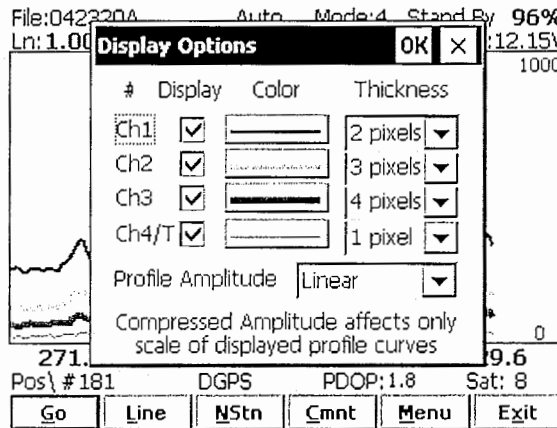

Please refer to chapter 5 where this dialog and its parameters are described in detail.

Tap the button **OK** or press **ENTER** key to accept updated display parameters. The dialog will disappear and profile plot area will be redrawn in Stand By mode.

To return to Stand By mode and current display options (state before this dialog was selected) tap **Cancel (X)** button or press **Esc** key, the dialog window will disappear.

### Nulling

This option is available only from pop up menu (accessible from **Menu** button) or directly from keyboard by using shortcut key <U>.

During data collection (in Stand By mode) a confirmation message will be displayed (there is no such message if Nulling is performed in Monitoring mode) before actual operation is applied.

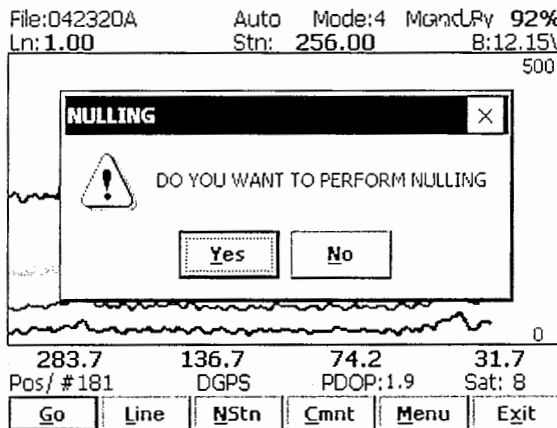

After above message is confirmed the program collects 50 readings and calculates the instrument offset.

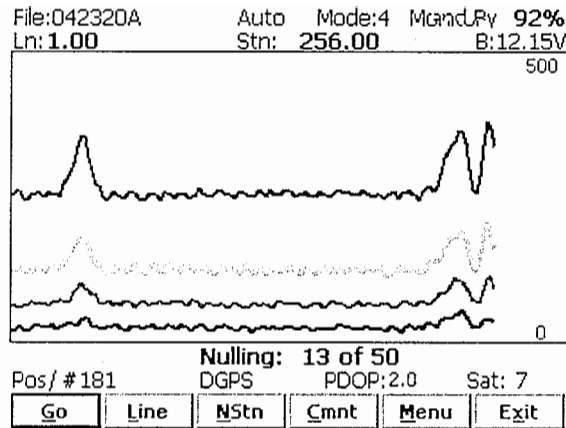

The calculated offset is applied to all the readings that follow this operation. If needed, this procedure can be repeated several times until satisfactory results are obtained. However, there is no associated “Undo” function. If original values (without calculated offsets) of the EM61-MK2 readings are needed, exit the EM61MK2 program and run it again. The EM61-MK2 instrument does not have to be turned OFF.

**Internal Calibration** (*Internal QC coil calibration*)

The Internal QC coil calibration is described in detail in the EM61-MK2 Operating Instructions. During data logging in Stand By mode this option is available only from the pop up menu (accessible from **Menu** button) or directly from the keyboard by using shortcut key <I>.

The Internal Calibration process begins by performing the automatic nulling which in this case is only in effect for the duration of the calibration process. It will not affect EM61-MK2 readings. After the nulling is completed (less than 5 seconds) the Internal QC Coil Calibration window is displayed.

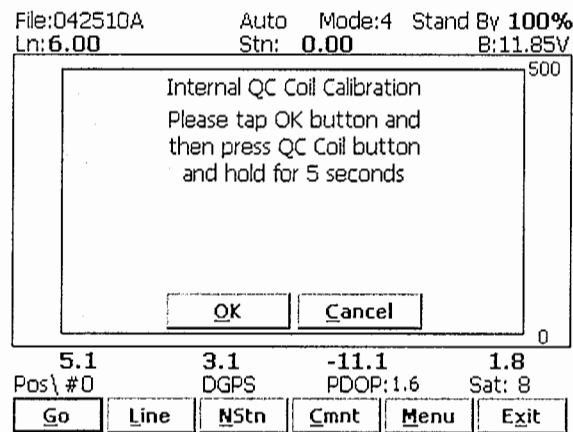

After **OK** button is tapped (or shortcut key **O** is pressed) the window displays timer with elapsed seconds and EM61-MK2 readings. This display lasts for 60 seconds. During this time please follow the instructions provided on the Allegro screen.



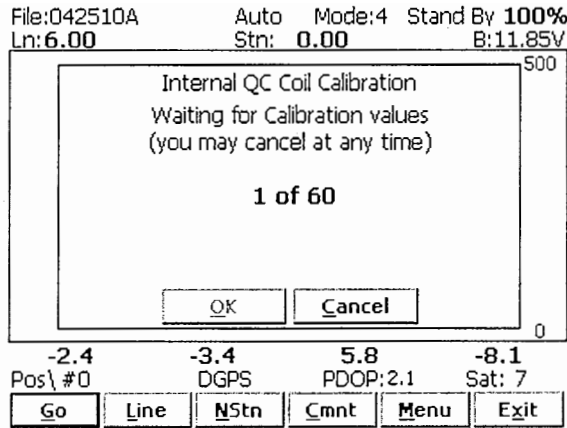

Internal QC coil calibration can end in the following four ways:

The process can be stopped by an operator at any time by tapping **Cancel** button or pressing shortcut key **C**.

The calibration may end by time out (60 seconds) if QC coil button was not pressed or this action did not activate QC coil. The following screen will then be displayed:

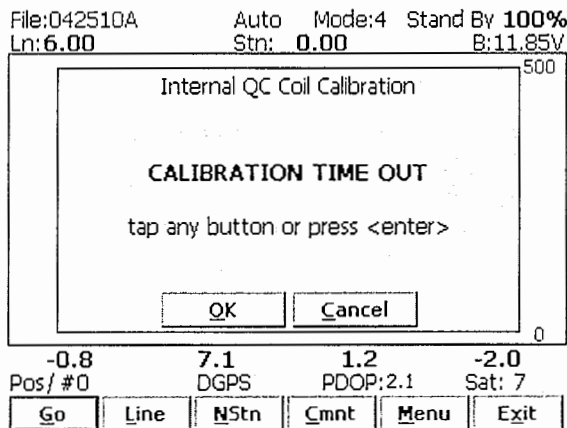

After pressing any key the program returns to logging window in Stand By mode. To repeat Internal QC coil calibration please repeat the procedure.

The logger will determine if the instrument has passed test. If after activating the QC coil, the program determines that the reading is inside the standard values within +/- 10% tolerances then a message "CALIBRATION OK" will be displayed (see below).

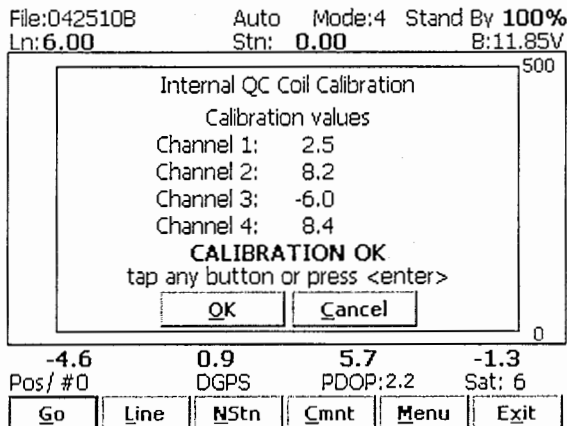

Otherwise, if the program determines that the reading is outside of the test values range the corresponding message “CALIBRATION FAILED” is displayed.

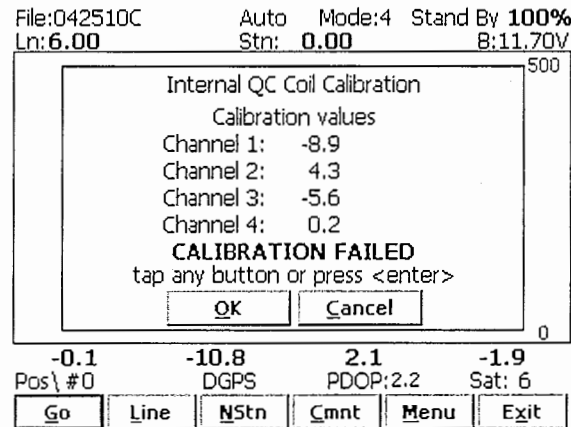

Regardless of the test result (OK or FAILED) the readings will be saved on screen. The program returns to logging window in Stand By mode after any button is tapped or ENTER key is pressed. Then the Internal QC coil calibration process can be repeated.

**External Calibration** (*External QC coil calibration*)

The External QC coil calibration option is described in detail in the EM61-MK2 Operating Instructions. During data logging (when logging window is in Stand By mode) this option is available only from pop up menu (accessible from **Menu** button) or directly from keyboard by using shortcut key <E>.

The External calibration action begins by performing the automatic nulling which in this case is only in effect for the duration of the calibration process. It will not affect EM61-MK2 readings. After the nulling is completed (less than 5 seconds) the External QC coil Calibration window is displayed.

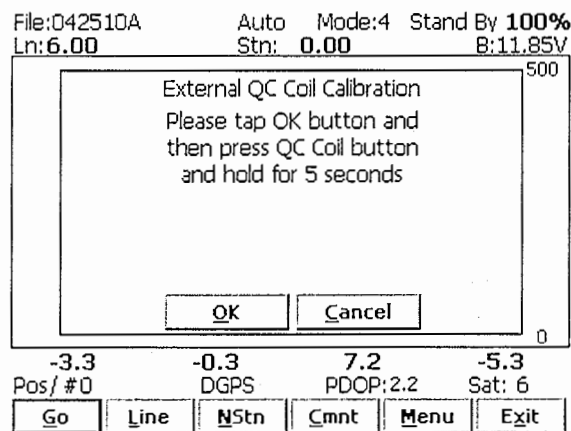

After the **OK** button is tapped (or shortcut key **O** is pressed) the window displays a timer with elapsed seconds and EM61-MK2 readings. This display lasts for 60 seconds. During this time please follow the instructions provided on the Allegro screen.

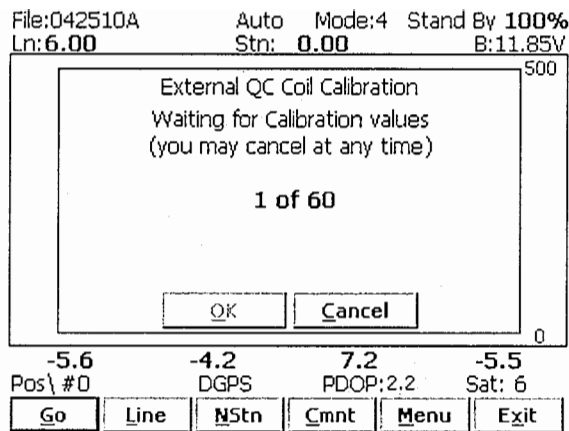

External QC coil calibration can end in the following four ways:

The process can be stopped by an operator at any time by tapping **Cancel** button or pressing shortcut key **C**.

The calibration may end by time out (60 seconds) if the External QC coil button was not pressed or this action did not activate QC coil. The following window will then be displayed (see below).

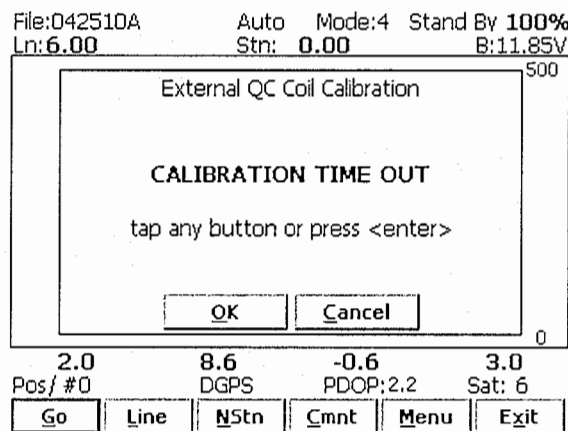

After pressing any key the program returns to Stand By mode window. To repeat External QC coil calibration please repeat the procedure.

The logger will determine if the instrument has passed test. If after activating the QC coil, the program determines that the reading is inside the standard values within +/- 10% tolerances then a message "CALIBRATION OK" will be displayed.

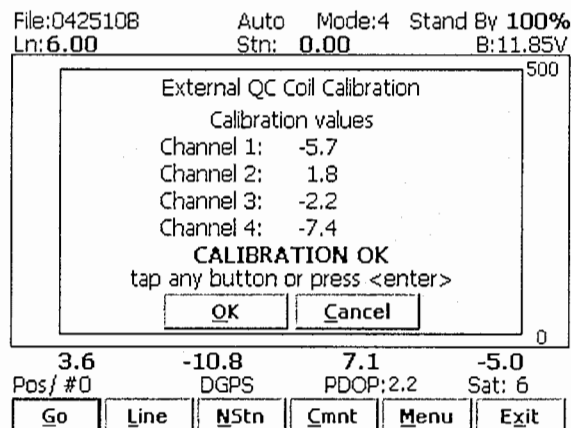

Otherwise, if the program determines that the reading is outside of the test values range the corresponding message “CALIBRATION FAILED” is displayed.

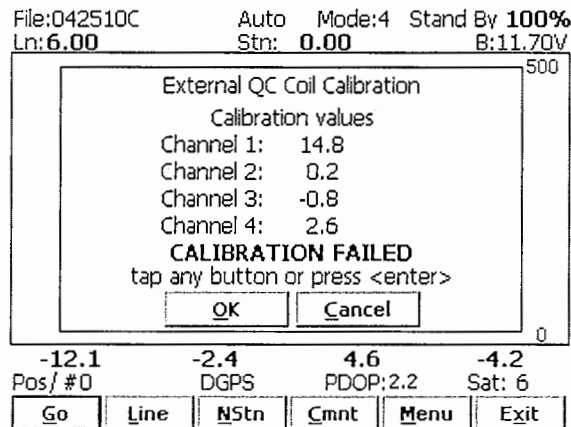

Regardless of the test result (OK or FAILED) the readings will be saved on screen. The program returns to Monitoring window after any button is tapped or ENTER key is pressed. Then the Internal QC coil calibration process can be repeated.

**Exit** (*exit data logging*)

During data collection (in Stand By mode) a confirmation message will be displayed (there is no such message if **Exit** is performed in Monitoring mode) before program exits logging window.

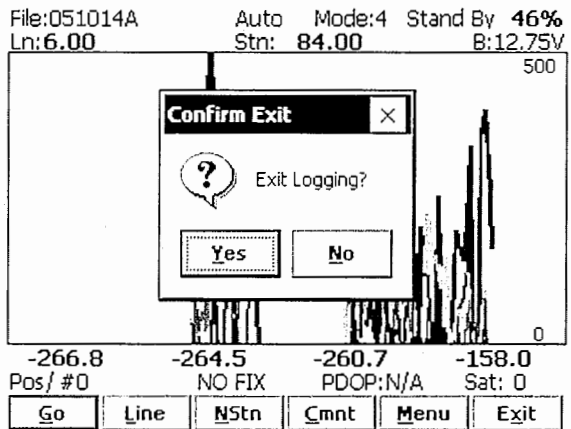

After above message is confirmed the program stops logging, closes data file and returns to Main Screen.

## 8. View Data Files

This option allows you to view recorded data files. After the View Files button is tapped (or executed from the keyboard) in the Main Screen the View Data Files window will be displayed.

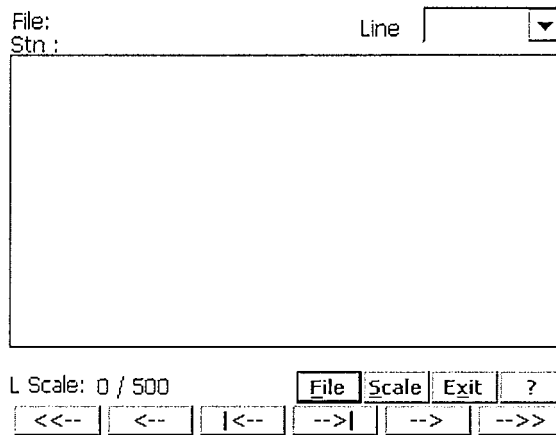

To open the data file tap the button labeled **File** or execute this option using the keyboard (navigate to the button by pressing **TAB** key and when highlighted press **ENTER** key, or use shortcut - press key **F**). The Open Data File dialog is presented below.

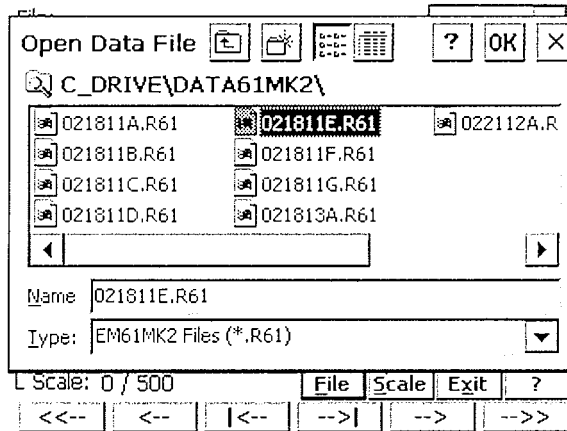

The file name can be selected in the Open Data File dialog using the Windows standard interface procedure. After the file is selected (highlighted) tap the button **OK** or press **ENTER** key to accept and display data file (to cancel selection tap **Cancel** (X) button or press **Esc** key). After the file is opened readings taken at the beginning of the first survey line in the file are displayed, as shown below.

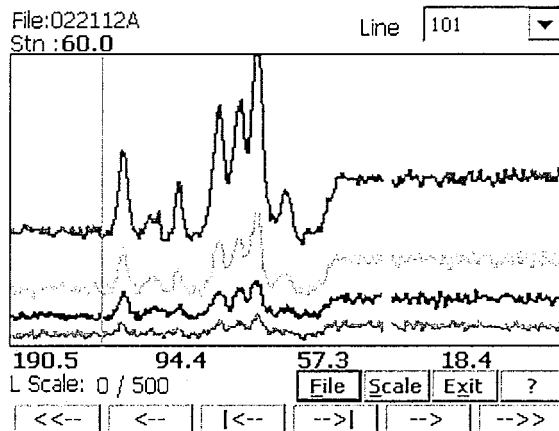

Name of the currently displayed data file is shown in the left top corner of the window. The main portion of the screen is occupied by the plot area which displays profiles. Readings in the plot area can be displayed in linear or compressed amplitude scale. Amplitude scale as well as display range (minimum and maximum value) is given by label located at the left bottom of the window (i.e. **L Scale: 0/500** means linear scale from 0 to 500 mV). The amplitude scale is set only in the Display Options window (see chapter 5) and range of scale display can be changed by tapping the button labeled **Scale**. The plot area is divided by four or five grey grid lines. In cases where the amplitude scale starts with a negative value, then the grid line corresponding to zero is always plotted as a thicker line.

A vertical bar (grey vertical line) indicates currently displayed station. The station is displayed above the plot area, next to label **Stn:** and readings at this station for channels 1, 2, 3, and 4 (or **T**) are shown in numeric form below the plot area. Channel labels are not displayed due to the small screen of the Allegro. Values of readings are displayed in the following order (from the left): Channel 1, 2, 3, and 4 (or T). EM61-MK2 readings (in numeric form) are updated every time vertical bar is moved.

To change the currently displayed survey line use the drop-down box labeled **Line** located in the top right corner of the window. Tapping on the down arrow next to the text box labeled **Line** opens a drop-down box showing the available survey lines. When the keyboard is being used you can activate the text box by pressing the **TAB** key until the drop down box is highlighted and then by using Up or Down arrow keys select one of available lines (as shown below).

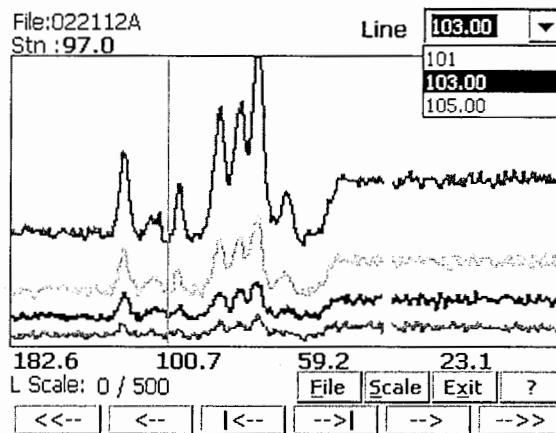

To shift the range of the displayed stations and to move the vertical bar indicating the currently displayed station, use the buttons located along the bottom of the View Files window. These buttons can be activated by tapping or by pressing the keyboard keys. A help screen containing info related to each button can be displayed at any time by tapping (or executing from keyboard) the Help button labeled **?**. The Help screen is shown below.

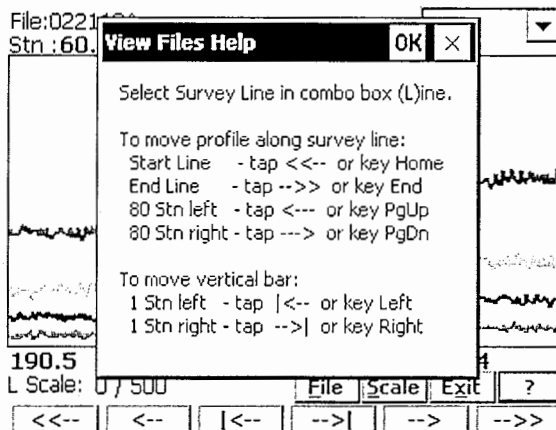

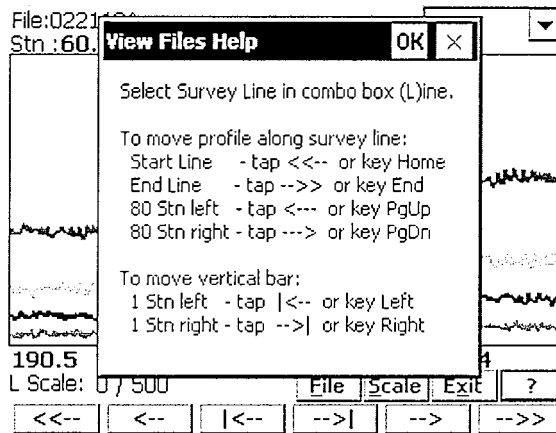

When moving displayed profile along survey line:

- button labeled <<-- or key **Home** moves display to the start of the currently displayed survey line, the left most station is the start station of the line,
- button labeled -->> or key **End** moves display to the end of the currently displayed survey line, the right most station is a final station of the survey line,
- button labeled <--- or key **PgUp** moves display 80 stations to the left,
- button labeled ---> or key **PgDn** moves display 80 stations to the right.

When changing stations and corresponding readings:

- button labeled |<-- or key **Left** (left arrow) moves vertical bar (station) one station to the left,
- button labeled -->| or key **Right** (right arrow) moves vertical bar (station) one station to the right.

To exit the View Files window tap the button labeled **Exit** (or from keyboard use shortcut key **X** or press key **ENTER** when the button is highlighted) to close file (if open). The program will return to Main Screen.





# Appendix A

## A.1 Description of Data File in EM61MK2 Allegro CX Format

Each record contains 24 characters, including line feed at the end of each record.

**Header of the file (contains six records starting with characters E, H, O, O, O, and O)**

1	2	3	4	5	6	7	8	9	10	11	12	13	14	15	16	17	18	19	20	21	22	23	24	
E	M	6	1	M	K	2		W	1	1	0	Survey Type	UT	IT	IM									10
H													File Name											10
O													Offset for Ch1 (F9.2)	IC										10
O													Offset for Ch2 (F9.2)	IC										10
O													Offset for Ch3 (F9.2)	IC										10
O													Offset for Ch4 (F9.2)	IC										10

EM61MK2	-	identification of program file
W110	-	version number (1.10, W - indicates file created by Windows CE program)
Survey Type	-	GPS (if GPS Input Enabled) or GRD (grid)
UT	-	unit type (0 = meters, 1 = feet)
IT	-	instrument type (0 =sensor 1x0.5m, 1 = 1x1m, 2 = 0.5x0.5m, 3 = HH61)
IM	-	instrument mode (0 =Auto, 1 =Wheel, and 2 =Manual)
File Name	-	file name, maximum 8 characters
Time Increment	-	time increment (Auto Mode) in seconds
Offset	-	offset for indicated channels in mV
IC	-	QC coil calibration (=N not performed, <>N otherwise)
QC coil value	-	value of QC coil calibration for indicated channels in mV
10	-	Line Feed character

**Header at the start of survey line (eight records starting with L, B, A, Z, O, O, O, O)**

1	2	3	4	5	6	7	8	9	10	11	12	13	14	15	16	17	18	19	20	21	22	23	24	
L																								10
B																								10
A	Dir																							10
Z	D	D	M	M	Y	Y	Y	Y		H	H	:	M	M	:	S	S							10
O													Offset for Ch1 (F9.2)											10
O													Offset for Ch2 (F9.2)											10
O													Offset for Ch3 (F9.2)											10
O													Offset for Ch4 (F9.2)											10

Line Name	-	Line Name, maximum 8 characters
Start Station	-	Start Station for the Line, format F11.2
Dir	-	Direction of the Line (E, W, N, or S)
Station Inc.	-	Station Increment, format F11.3
Date	-	Date when Line was created, format DD-MM-YYYY
Time	-	Real Time when Line was created, format HH:MM:SS
Offset	-	Offset for indicated channels in mV at the start of Line
Former Offset	-	Former offset for indicated channels in mV
10	-	Line Feed character

**Timer Relation**

1	2	3	4	5	6	7	8	9	10	11	12	13	14	15	16	17	18	19	20	21	22	23	24
*	Computer Time (Format HH:MM:SS.sss)												Time Stamp in milliseconds										10

Indicates relation between computer clock and the program timer. This record links timer in milliseconds and computer time (local time) in format HH:MM:SS.sss. This record is written to the file each time a new new line is entered.

**Reading**

1	2	3	4	5	6	7	8	9	10	11	12	13	14	15	16	17	18	19	20	21	22	23	24
I	Gn	1h	1l	2h	2l	3h	3l	4h	4l	5h	5l	6	Time Stamp in ms (10 digits)										10

- I - indicator T, D, E, F, M, N, P, or Q. Each record representing reading starts with one of the following character, which indicates type of reading:
  - T - Standard, Mode 4, channels 1, 2, 3, 4
  - D - Standard, Mode D, channels 1, 2, 3, T
  - E - Hand Held, Mode 4, channels 1, 2, 3, 4
  - F - Hand Held, Mode D, channels 1, 2, 3, T
  - M - Standard, Mode 4, channels 1, 2, 3, 4 +Marker
  - N - Standard, Mode D, channels 1, 2, 3, T +Marker
  - P - Hand Held, Mode 4, channels 1, 2, 3, 4 +Marker
  - Q - Hand Held, Mode D, channels 1, 2, 3, T +Marker
- Gn - one character parameter (Hex format), contains Gain, see table of ranges at the end of this section.
- 1h - higher byte of the 2's complement Hex number of Channel 1
- 1l - lower byte of Channel 1
- 2h - higher byte of the 2's complement Hex number of Channel 2
- 2l - lower byte of Channel 2
- 3h - higher byte of the 2's complement Hex number of Channel 3
- 3l - lower byte of Channel 3
- 4h - higher byte of the 2's complement Hex number of Channel 4
- 4l - lower byte of Channel 4
- 5h - higher byte of the 2's complement Hex number of TX current
- 5l - lower byte of TX current
- 6 - fraction of current (5h 5l), Hex number
- Time Stamp - time in ms from the Windows start (resets every 49.7 days)
- 10 - Line Feed character

**Comment**

1	2	3	4	5	6	7	8	9	10	11	12	13	14	15	16	17	18	19	20	21	22	23	24
C	Comment (maximum 11 characters)											Time Stamp in ms (10 digits)										10	

**New Station**

1	2	3	4	5	6	7	8	9	10	11	12	13	14	15	16	17	18	19	20	21	22	23	24
S	New Station (Format 11.2)											Time Stamp in ms (10 digits)										10	

**Nulling**

1	2	3	4	5	6	7	8	9	10	11	12	13	14	15	16	17	18	19	20	21	22	23	24
O	Offset for Ch1 (F9.2)											Former Offset for Ch1 (F9.2)										10	
O	Offset for Ch2 (F9.2)											Former Offset for Ch2 (F9.2)										10	
O	Offset for Ch3 (F9.2)											Former Offset for Ch3 (F9.2)										10	
O	Offset for Ch4 (F9.2)											Former Offset for Ch4/T (F9.2)										10	

**QC Coil Calibration**

1	2	3	4	5	6	7	8	9	10	11	12	13	14	15	16	17	18	19	20	21	22	23	24
I	C	Offset for Ch1 (F9.2)																					10
I	C	Offset for Ch2 (F9.2)																					10
I	C	Offset for Ch3 (F9.2)																					10
I	C	Offset for Ch4 (F9.2)																					10

IC - **II** indicates Inrenal QC coil calibration,  
**IE** indicates External QC coil calibration.

**GPS Data Message Records**

Each GPS record (GGA Message) is broken in to several 22 characters strings and placed in the EM61MK2 data file which contains 24 characters records, including one character indicator and line feed at the end of each record. The GPS sequence starts at the line which contains character @ as the first character, then records that contain continuation of the same message start with character #. The GPS sequence ends with a line starting with the character !. The last line contains logger time stamp in milliseconds for given GPS reading. A sample of the GPS message written in EM61MK2 format is given below.

1	2	3	4	5	6	7	8	9	10	11	12	13	14	15	16	17	18	19	20	21	22	23	24
@	\$	G	P	G	G	A	,	h	h	m	m	s	s	.	s	s	,	d	d	m	m	.	10
#	m	m	m	m	m	,	s	,	d	d	d	m	m	.	m	m	m	m	m	,	s	,	10
#	n	,	q	q	,	p	p	.	p	,	s	a	a	a	a	a	.	a	a	,	u	,	10
#	±	x	x	x	x	.	x	,	M	,	s	s	s	,	a	a	a	*	c	c	CR	LF	10
!												Time Stamp in milliseconds										10	

The GPS sequence may contain 4 to 6 records. Component of the GGA message may differ in length, however they are placed in the same number of columns. Refer to Appendix B (section B.2) for definition of each component of GGA data message.

## A.2 Conversion Factors

EM61MK2 has four channels. Channels 1, 2, and 3 are common for Mode 4 and Mode D. Channel 4 in Mode D is named Channel T (it corresponds to Top coil).

The instrument response is converted to output voltage in mV for each sampling channel as given below.

Channel 1 to 4 - converted data  
DATA1 (to 4) - instrument output for each channel as recorded in logger  
RANGE - range is controlled by the EM61MK2, it can be 1, 10, 100

**Standard Unit - Mode 4** (One Sensor 1 x 0.5 m or 1 x 1 m)

$$\text{Channel 1} = (\text{DATA1} \times 4.8333 \times 2) / \text{RANGE}$$

$$\text{Channel 2} = (\text{DATA2} \times 4.8333 \times 2) / \text{RANGE}$$

$$\text{Channel 3} = (\text{DATA3} \times 4.8333 \times 2) / \text{RANGE}$$

$$\text{Channel 4} = (\text{DATA4} \times 4.8333 \times 2) / \text{RANGE}$$

**Standard Unit - Mode D** (Two Sensors 1 x 0.5 m or 1 x 1 m, Top and Bottom coils)

$$\text{Channel 1} = (\text{DATA1} \times 4.8333 \times 2) / \text{RANGE}$$

$$\text{Channel 2} = (\text{DATA2} \times 4.8333 \times 2) / \text{RANGE}$$

$$\text{Channel 3} = (\text{DATA3} \times 4.8333 \times 2) / \text{RANGE}$$

$$\text{Channel T} = (\text{DATA4} \times 4.8333 \times 4) / \text{RANGE}$$

if coil is 1 x 0.5 m Channel T is further multiplied by a factor 1.114.

**Hand Held Unit - Mode 4** (One Sensor)

$$\text{Channel 1} = 0.902500 \times (\text{DATA1} \times 4.8333) / \text{RANGE}$$

$$\text{Channel 2} = 1.363000 \times (\text{DATA2} \times 4.8333) / \text{RANGE}$$

$$\text{Channel 3} = 2.026795 \times (\text{DATA3} \times 4.8333) / \text{RANGE}$$

$$\text{Channel 4} = 3.018856 \times (\text{DATA4} \times 4.8333) / \text{RANGE}$$

**Hand Held Unit - Mode D** (Two Sensors, Top and Bottom coils)

$$\text{Channel 1} = 0.9025 \times (\text{DATA1} \times 4.8333) / \text{RANGE}$$

$$\text{Channel 2} = 1.3630 \times (\text{DATA2} \times 4.8333) / \text{RANGE}$$

$$\text{Channel 3} = 2.0430 \times (\text{DATA3} \times 4.8333) / \text{RANGE}$$

$$\text{Channel T} = 12.152 \times (\text{DATA4} \times 4.8333) / \text{RANGE}$$

Further each channel is normalized by current following formula:

**Standard Unit**

$$\text{Channel} = \text{Channel} \times 3000 / \text{Current}$$

**Hand Held Unit**

$$\text{Channel} = \text{Channel} \times 1800 / \text{Current}$$

where, current is a value represented by 5h, 5l, and 6 in EM61MK2 data file (see section B.1)

Table of Ranges Determined by the EM61-MK2 Microprocessor

HEX	Ch1	Ch2	Ch3	Ch4	HEX	Ch1	Ch2	Ch3	Ch4	HEX	Ch1	Ch2	Ch3	Ch4
0	1	1	1	1	40	10	1	1	1	C0	100	1	1	1
1	1	1	1	10	41	10	1	1	10	C1	100	1	1	10
3	1	1	1	100	43	10	1	1	100	C3	100	1	1	100
4	1	1	10	1	44	10	1	10	1	C4	100	1	10	1
5	1	1	10	10	45	10	1	10	10	C5	100	1	10	10
7	1	1	10	100	47	10	1	10	100	C7	100	1	10	100
C	1	1	100	1	4C	10	1	100	1	CC	100	1	100	1
D	1	1	100	10	4D	10	1	100	10	CD	100	1	100	10
F	1	1	100	100	4F	10	1	100	100	CF	100	1	100	100
10	1	10	1	1	50	10	10	1	1	D0	100	10	1	1
11	1	10	1	10	51	10	10	1	10	D1	100	10	1	10
13	1	10	1	100	53	10	10	1	100	D3	100	10	1	100
14	1	10	10	1	54	10	10	10	1	D4	100	10	10	1
15	1	10	10	10	55	10	10	10	10	D5	100	10	10	10
17	1	10	10	100	57	10	10	10	100	D7	100	10	10	100
1C	1	10	100	1	5C	10	10	100	1	DC	100	10	100	1
1D	1	10	100	10	5D	10	10	100	10	DD	100	10	100	10
1F	1	10	100	100	5F	10	10	100	100	DF	100	10	100	100
30	1	100	1	1	70	10	100	1	1	F0	100	100	1	1
31	1	100	1	10	71	10	100	1	10	F1	100	100	1	10
33	1	100	1	100	73	10	100	1	100	F3	100	100	1	100
34	1	100	10	1	74	10	100	10	1	F4	100	100	10	1
35	1	100	10	10	75	10	100	10	10	F5	100	100	10	10
37	1	100	10	100	77	10	100	10	100	F7	100	100	10	100
3C	1	100	100	1	7C	10	100	100	1	FC	100	100	100	1
3D	1	100	100	10	7D	10	100	100	10	FD	100	100	100	10

## A.3 Example of Data File in EM61MK2 (Allegro CX) Format

The Em61MK2 data file records are written in binary format, therefore the file may have different shape when displayed or printed, depending on particular video or printer settings.

```
EM61MK2 W100GPS000
H 042320A 0.200
O 0.00E 0.00
O 0.00E 0.00
O 0.00E 0.00
O 0.00E 0.00
LO
B 0.00
AS 1.000
Z23042005 20:02:51
O 0.00 0.00
O 0.00 0.00
O 0.00 0.00
O 0.00 0.00
*20:02:51.000 4179829
@$GPGGA,020412.00,4336.
#59410,N,07936.64856,W,
#2.6,2,141.56,M,-35,M,5
#,119*55
! 4287423
@$GPGSA,A,3,30,,25,,20
#,14,,06,,01,02.8,02.1
#,02.0*0D
! 4287441
Eÿø `/^ "N 4287673
Eÿ t/" "Q 4287879
C comment text 4287983
Eÿ: G/yi "O 4288089
Eÿ$ h/zb "W 4288279
@$GPGGA,020413.00,4336.
#59408,N,07936.64857,W,
#2.6,2,141.51,M,-35,M,6
#,119*58
! 4288338
Eÿñ 5/ # "S 4288488
@$GPGSA,A,3,30,,25,,20
#,14,,06,,01,02.8,02.1
#,02.0*0D
! 4288419
Eÿb o/i "O 4288677
EÿL t/k "Q 4288885
@$GPGGA,020414.00,4336.
#59411,N,07936.64846,W,
#2.6,2,141.68,M,-35,M,6
#,119*5D
! 4289337
Eÿ4 (/± " 4290288
@$GPGGA,020415.00,4336.
#59411,N,07936.64845,W,
#2.6,2,141.69,M,-35,M,7
#,119*5F
! 4290338
EÿÈ 1/Y " 4290496
@$GPGSA,A,3,30,,25,,20
#,14,,06,,01,02.8,02.1
#,02.0*0D
! 4290417
Eÿtr /F 4290687
Eÿkø/ à " 4290893
Eÿh/IA " 4291101
Eÿ2 A/5Ñ " 4291293
@$GPGGA,020416.00,4336.
#59420,N,07936.64848,W,
#2.6,2,142.11,M,-35,M,4
#,119*5C
! 4291335
E
tsÿ3 " 4291502
@$GPGSA,A,3,30,,25,,20
#,14,,06,,01,02.8,02.1
#,02.0*0D
! 4291414
Eÿ*, bE "Y 4291691
C building 4291793
E
# *â "V 4291900
E,/D "C 4292299
```

---

# Appendix B

## B.1 Using the EM61MK2 with a GPS Receiver

The EM61MK2 program accepts input from GPS receiver that stream NMEA-0183 compatible data through their output port. The program uses two NMEA messages: GGA and GSA. The entire GGA message is used later by the DAT61MK2 program, while the GSA message is used only to display PDOP index on the logger screen.

The GPS system means (control device, receiver panel, or manufacturer software) must be used to set GPS receiver communication parameters, to specify frequency of GPS output, and number and type of NMEA messages sent by the GPS system output port. Any GPS system can send various NMEA messages. **It is important to select only two messages (GGA and GSA) that are actually used by EM61MK2.** The program will accept any GPS string sent by the GPS receiver, however it uses time to process GPS data that is not being used. Therefore, selecting a larger number of NMEA messages for GPS output will result in slower data acquisition of EM61MK2. Normally, the EM61MK2 running in Allegro CX logger uses less than 100 ms to process and record GPS data from two NMEA messages, GGA and GSA.

Only message GGA is necessary to position EM61MK2 data. If message GSA is not available in a particular system, the EM61MK2 will function and record position data based on GGA message. Lack of GSA message will result in PDOP index displayed as Not Available (N/A) on the logger display. Using message GGA alone will also result in slightly faster operation of the program. The speed can be further improved by setting higher Baud Rate (if it is supported by the employed GPS receiver) in Set GPS Port menu.

The EM61MK2 dedicates one line of the display to show GPS status. A label **DGPS** (Differential Global Positioning System) that GPS readings are differentially corrected in real time. Label **AGPS** (Autonomous Global Positioning System) indicates lack of differential correction. On the right side of the **POS** a label slash character is displayed. This slash alternates between forward and back slash with the frequency of GPS update rate (usually 1 second intervals). If the slash is not moving for longer period of time it means that GPS system is not working or that it is not connected to the field computer. Number of recorded GPS positions are displayed on the right side of the alternating slash following # sign. This number is updated only in the logging mode, when the data are recorded. (In Stand By mode or during Monitoring only the alternating slash, and updated values of PDOP and number of tracked satellites, indicate presence of GPS input).

Two more GPS parameters are displayed on the logger screen. These are index PDOP shown by label **PDOP** and number of tracked satellites represented by label **Sat**. The index called PDOP (Position Dilution of Precision) measures the strength of satellite coverage for a given area. PDOP is affected by the number of satellites visible and their relative positions in the sky. The smaller the number of PDOP the stronger the satellite coverage is. When there are more than 5 satellites widely spaced visible, the PDOP is 4 or less. However, when there are less satellites visible, or they are unevenly spaced in the sky, PDOP values can be 6 or higher. In most cases, the PDOP in an open sky is less than 3, and most accuracies given for many GPS systems are given for this norm. Refer to GPS documentation and literature for more information related to error sources of GPS positioning.

## B.2 Description of GGA and GSA Data Messages

### GGA Data Message

The GGA message contains the GPS position information and it is the most widely used NMEA data message. This message takes the following form:

```
$GPGGA,hhmmss.ss,ddmm.mmmmm,s,dddmm.mmmmm,s,n,qq,pp.p,saaaaa.aa,u,  
±xxxx.x,M,sss,aaaa*cc<CR><LF>
```

Definition of GGA message component:

hhmmss.ss	UTC time in hours, minutes, seconds of the GPS position
ddmm.mmmmm	Latitude in degrees, minutes, and decimal minutes
s	s=N or s=S, for North and South latitude
dddmm.mmmmm	Longitude in degrees, minutes, and decimal minutes
s	s=E or s=W, for East and West longitude
n	Quality indicator, 0 = no position, 1 = raw, no differentially corrected position, 2 = differentially corrected position, 9 = position computed using almanac information
qq	Number of satellites used in position computation
pp.p	HDOP = 0.0 to 99.9
saaaaa.aa	Antenna altitude
u	Altitude units, M=meters
±xxxx.x	Geoidal separation (requires geoidal height option)
M	Geoidal separation units, M = meters
sss	Age of differential corrections in seconds
aaaa	Base station identification
*cc	Checksum
<CR><LF>	Carriage return and Line feed

### GSA Data Message

The GSA message contains active satellites and PDOP value. The GSA message is given in the following form:

```
$GPGSA,c1,d1,d2,d3,d4,d5,d6,d7,d8,d9,d10,d11,d12,d13,f1,f2,f3*cc<CR><LF>
```

Definition of GSA message components:

c1	Mode, M = manual, A = automatic
d1	Mode, 2 = 2D, 3 = 3D
d2-d13	Satellites used in position computation (range 0 to 32)
f1	PDOP (range 0 to 99.9)
f2	HDOP (range 0 to 99.9)
f3	VDOP (range 0 to 99.9)
*cc	Checksum
<CR><LF>	Carriage return and Line Feed



## B.3 Example of Converted Output Format

If Output in Set Output Port was enabled and the option labeled Format was set to Converted the data will be sent through serial port to external device in the following format.

```

082216G.R61
L1010
AS
Z08222002 16:42:44.000
E 14.00 164.60 90.09 40.10 123.70 4287123
E 13.00 166.18 88.16 40.48 124.96 4287622
$GPGGA,214218.00,4336.59343,N,07936.65086,W,2,7,1,139.61,M,-35,M,4,118*50 4287623
E 12.00 161.02 91.85 41.33 120.28 4288018
E 11.00 165.47 92.22 37.72 123.65 4288520
$GPGGA,214219.00,4336.59342,N,07936.65088,W,2,7,1,139.50,M,-35,M,5,118*5D 4288623
E 10.00 168.53 90.49 41.03 127.45 4289023
E 9.00 168.09 89.97 42.26 126.31 4289523
$GPGGA,214220.00,4336.59340,N,07936.65086,W,2,7,1,139.48,M,-35,M,4,118*53 4289622
E 8.00 161.19 83.53 45.38 120.79 4290123
E 7.00 167.16 87.46 44.43 125.57 4290523
$GPGGA,214221.00,4336.59344,N,07936.65087,W,2,7,1,139.71,M,-35,M,5,118*5C 4290623
E 6.00 163.30 91.15 42.72 121.75 4290993
$GPGGA,214222.00,4336.59342,N,07936.65087,W,2,7,1,139.55,M,-35,M,6,118*5C 4291619
Ccars 16:43:28.940
S 0.00 16:43:40.910
E 0.00 159.82 87.55 41.14 120.02 4311505
$GPGGA,214242.00,4336.59338,N,07936.65084,W,2,7,1,139.31,M,-35,M,4,118*54 4311619
E -1.00 164.09 85.39 42.08 123.52 4312019
E -2.00 168.11 89.50 38.59 125.47 4312549
$GPGGA,214243.00,4336.59333,N,07936.65081,W,2,7,1,139.40,M,-35,M,5,118*5C 4312621
E -3.00 163.27 91.27 39.43 121.26 4313033
$GPGGA,214244.00,4336.59338,N,07936.65082,W,2,7,1,139.39,M,-35,M,4,118*5C 4313620
E -4.00 173.31 85.18 39.15 129.80 4314076
E -5.00 167.73 86.50 40.46 125.44 4314501
$GPGGA,214245.00,4336.59337,N,07936.65082,W,2,7,1,139.39,M,-35,M,5,118*53 4314625
E -6.00 160.22 89.60 41.87 119.69 4315012
E -7.00 156.22 86.11 41.21 116.17 4315543
$GPGGA,214246.00,4336.59340,N,07936.65081,W,2,7,1,139.39,M,-35,M,6,118*50 4315620
E -8.00 166.34 82.56 42.52 124.57 4316112
E -9.00 162.43 91.53 41.76 122.31 4316598
L1011
AN
Z08222002 16:43:52.000
E -13.00 164.46 86.29 42.02 123.07 4323150
E -12.00 166.59 90.96 38.07 124.89 4323623
$GPGGA,214255.00,4336.59338,N,07936.65086,W,2,7,1,139.40,M,-35,M,5,118*57 4324050
E -11.00 162.35 84.26 36.85 121.94 4324152
E -10.00 164.98 84.38 39.85 122.63 4324650
$GPGGA,214256.00,4336.59336,N,07936.65084,W,2,7,1,139.56,M,-35,M,4,118*5E 4325045
E -9.00 158.19 83.68 42.57 118.85 4325145
E -8.00 160.18 89.11 41.25 120.10 4325644
$GPGGA,214257.00,4336.59339,N,07936.65086,W,2,7,1,139.69,M,-35,M,5,118*5F 4326048
E -7.00 162.64 88.78 37.40 122.74 4326123
E -6.00 166.85 89.09 39.56 124.83 4326677
$GPGGA,214258.00,4336.59338,N,07936.65082,W,2,7,1,139.59,M,-35,M,6,118*55 4327042
E 3.00 167.44 84.42 40.87 124.98 4327112
E 4.00 165.91 82.21 37.78 124.29 4327633
$GPGGA,214304.00,4336.59336,N,07936.65084,W,2,6,1,139.48,M,-35,M,6,118*54 4328041
E 5.00 167.22 86.83 38.72 125.98 4328126
E 6.00 164.38 90.12 39.10 122.34 4328652
$GPGGA,214305.00,4336.59336,N,07936.65083,W,2,6,1,139.45,M,-35,M,5,118*5C 4329044
E 7.00 166.56 86.78 39.47 125.00 4329156
E 8.00 163.56 84.19 40.42 124.17 4329634
$GPGGA,214306.00,4336.59336,N,07936.65088,W,2,6,1,139.49,M,-35,M,5,118*58 4330051
E 9.00 168.66 87.61 42.58 128.10 4330122

```



**B2. EM61-MK2xp DATA LOGGING SYSTEM**

# OPERATING INSTRUCTIONS

EM61-MK2 DATA LOGGING SYSTEM  
FOR WINDOWS XP BASED FIELD COMPUTER

# EM61MK2xp

Version 1.01

December, 2006

## Geonics Limited

---

1745 Meyerside Drive, Mississauga, Ontario, Canada L5T 1C6  
Tel: (905) 670 9580 Fax: (905) 670 9204

*E-mail: [geonics@geonics.com](mailto:geonics@geonics.com)*



# Table of Contents

1.	Introduction .....	1
1.1	Program Requirements .....	2
1.2	Installing EM61MK2xp .....	2
1.3	Running EM61MK2xp Program .....	2
1.4	Main Screen .....	3
	Short description of Main Screen options .....	3
2.	Survey Setup .....	5
3.	Logger Setup .....	9
4.	Set Port for GPS & Monitoring .....	13
4.1	GPS Port Setup .....	13
4.1	Monitoring GPS Receiver Output .....	15
5.	Display Options .....	19
6.	Logging Data .....	21
6.1	Monitoring Mode .....	21
	Description of Monitoring Mode Options .....	24
6.2	Stand By Mode .....	32
6.3	Logging Mode .....	34
6.4	Stand By Mode Field Options .....	36
Appendix A	.....	45
A.1	Description of Data File in EM61MK2xp Format .....	45
A.2	Conversion Factors .....	48
A.3	Example of File in EM61MK2xp Format .....	50
Appendix B	.....	51
B.1	Using the EM61MK2xp with a GPS Receiver .....	51
B.2	Description of GGA and GSA Data Messages .....	52



---

# 1. Introduction

The Geonics EM61MK2xp Data Logging System (DAS70-XP) consists of a laptop field computer, data logging program EM61MK2xp, and associated cable to connect the computer to the Geonics EM61-MK2 instrument. The program EM61MK2xp is designed for a IBM PC compatible computer and MS Windows XP/2000 operating system.

The EM61MK2xp program acquires and records survey data from the EM61-MK2 system, under the control of the operator. It also records various field information such as survey line number (line name), starting station, increment, comments, etc. Readings are displayed in graphic and numeric mode. Readings are displayed in real time in mV. In addition, the program allows you to monitor the instrument output while data is not recorded. The EM61MK2xp program continuously monitors the condition of the instrument battery, without leaving the program. The EM61MK2 also provides the possibility of automatic nulling of the instrument output at any time during the survey.

The program allows the user to set the EM61-MK2 into a specific instrument mode of operation: AUTO, Wheel, or Manual modes. In AUTO mode readings can be automatically recorded in desired time intervals. In WHEEL mode readings are triggered by a counter installed at the EM61-MK2 wheel assembly, and in MANUAL mode readings are triggered manually by the operator.

The program supports the standard EM61-MK2 instrument as well as EM61-MK2 High Power unit. The program allows you to record data while using various EM61-MK2 antenna (1 x 0.5 m, 1 x 1 m, or 0.5 x 0.5 m sensors) and Geonics EM61HH-MK2 Hand Held sensor.

The EM61MK2xp will accept NMEA-0183 compatible data from a GPS receiver directly connected to an Allegro field computer. GPS data which are embedded in the EM61MK2xp data file can be processed later in the Geonics DAT61MK2 program. The connected GPS must be able to stream NMEA-0183 compatible messages. The EM61MK2xp uses two NMEA messages GGA and GSA. While message GGA is mandatory, the GSA string is used only to provide information related to the GPS signal quality during data collection.

The EM61MK2xp program records data together with a time stamp at each station. Data files created with this program can be used to position a survey according to locations recorded separately by a Global Positioning System (GPS).

Survey setup parameters are saved in a file, therefore they can be automatically used during subsequent data collection sessions.

Data files are saved to the user selected data directory. Data file names, which can be set by the program based on the computer clock or user specified, have extension names R61. Files can be converted to M61 format and viewed in DAT61MK2 program.

Number of readings in a data file is limited only by the hard drive capacity, however it is strongly recommended to avoid huge data files (i.e one to two hours long data files are adequate). The maximum speed of data collection is approximately 17 readings per second assuming 1 Hz (or less) GPS input. In graphic display mode, a profile containing the last 150 data readings is displayed for each channel.



## 1.1 Program Requirements

To successfully use this software, you will need :

### Computer

- PC field computer operating under Windows 2000 Pro, XP, or later,
- Minimum 256 Mb of RAM memory,
- CD drive or other mean to transfer files,
- minimum 800 x 600 pixel display resolution,
- serial Ports:
  - one serial port per instrument in array plus one serial port if directly connected
  - GPS receiver is to be used (USB to multiple RS-232 ports and PCMCIA RS-232 adapters can be used).

### Geonics EM61-MK2

The EM61-MK2 instrument with associated cables.

The EM61MK2xp program is stored on DAT61MK2 CD disk. All necessary initial files (with extension names .INI) are created in your field computer after the program is run for the first time. Check that the file EM61MK2xp.EXE is included on the CD disk.

## 1.2 Installing EM61MK2xp

The program consists of a standalone file EM61MK2xp.exe, no DLLs nor other libraries are required to run this program. The program is usually installed during data processing program DAT61MK2 installation, it is placed in subdirectory LogData of the selected installation directory.

If the program file is included separately on the DAT61MK2 CD disk, or downloaded from e-mail server it can be installed by copying the EM61MK2xp.exe file to any directory on your hard disk. This can be performed by using Windows Explorer.

After you run the program for the first time it will create permanent initial files (.INI) which contain some of the program settings. If the above files do not exist on the default drive they will be created with default parameters during the first execution of the program.

The EM61MK2xp data files contain extension name R61 and their base names should be limited to 8 characters.

## 1.3 Running EM61MK2xp Program

Start EM61MK2xp by double clicking the EM61MK2xp icon in the Start|Programs menu, in Windows Explorer, or on the desktop if a shortcut was created. At the start, EM61MK2xp displays the following screen.

The EM61MK2xp is a command button and dialog driven program. Command buttons can be executed by clicking with the left mouse button, or by pressing the indicated (underlined) character on the keyboard, or by using TAB to scroll through the buttons and ENTER to execute. In the Main Screen of the program Up and Down arrow keys can be also used to scroll through the buttons.

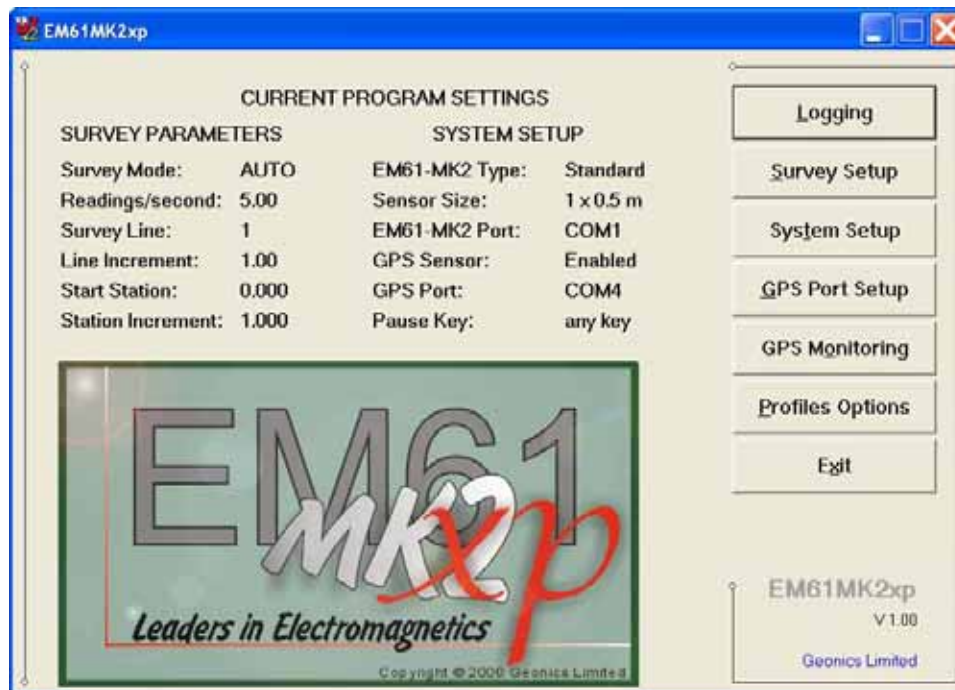

The Main Screen appears always as the first window after the program is started. It contains the name of the program, its version number (right bottom corner), and list of command buttons with available options on the right side. The major, left portion of the window contains information about current survey and system settings. This section is updated in real time as soon as the program parameters are changed in dialogs.

## 1.4 Main Screen

The Main Screen always appears after the program is started. It contains the name of the program, its version number, and a list of buttons representing the available options. The EM61MK2xp Main Screen is displayed below.

These options are selected by clicking on buttons, or from keyboard using TAB/ENTER or shortcuts indicated by underline label characters. In case of Main Screen buttons the **Down** and **Up** arrow keys and **<ENTER>** can be used as well.

Short description for each of the options follows.

### Short description of Main Screen options

#### **Monitor/Log**

This option allows to monitor and log the EM61-MK2 output. Monitor/Log screen starts always in Monitor mode, and then after a data file is created Logging mode is available. Monitor mode provides several options: the instrument nulling, performing Internal and External QC coil calibration, monitoring EM61-MK2 battery level, monitoring quality of GPS signal, etc.

### **Survey Setup**

The Survey Setup dialog will be displayed. All survey settings (survey line name, increments, etc.) can be specified in this dialog.

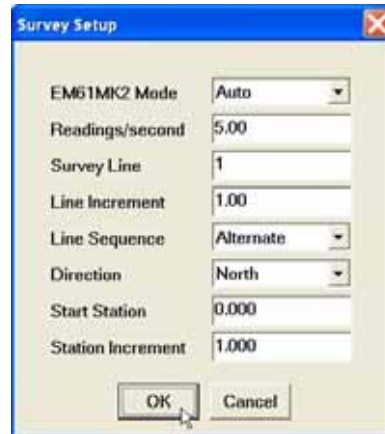

### **System Setup**

Dialog window that is associated with this option is used to set the instrument type, antenna size, serial port numbers, battery warning level, and type of pause key.

### **Set GPS Port**

The GPS Port Setup dialog allows to disable and enable GPS data acquisition. This option is also used to set the serial port number used for GPS input and to specify necessary serial port communication settings. GPS monitoring window can be accessed from this dialog as well.

### **Display Options**

The dialog which will allow you to specify colour and thickness of profile lines will appear. This dialog provides also choice of linear or compressed amplitude used for profile display.

### **Exit**

This option will terminate the program execution.

---

## 2. Survey Setup

The Survey Setup dialog, presented below, contains several parameters which affect two important procedures: instrument settings (instrument mode, frequency of data collection, etc.) and survey geometry layout (survey line names, line spacing, start station, station increment, etc.).

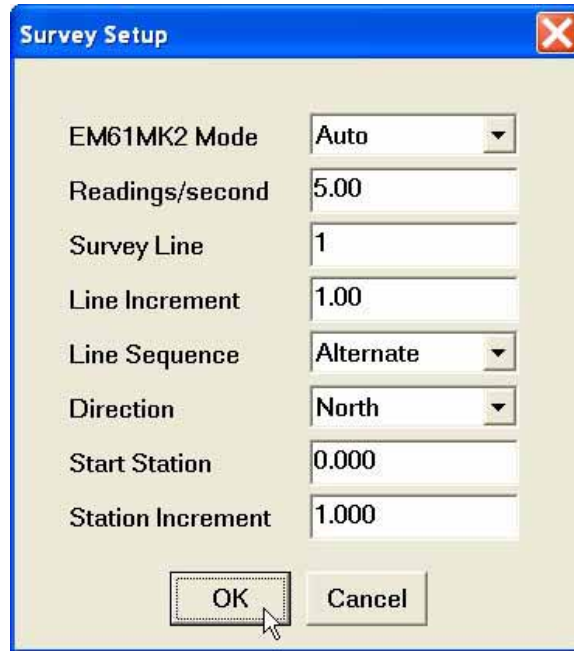

EM61MK2 Mode	Auto
Readings/second	5.00
Survey Line	1
Line Increment	1.00
Line Sequence	Alternate
Direction	North
Start Station	0.000
Station Increment	1.000

To select any option click on the corresponding drop-down list box or text box, or use TAB key to scroll to the option and then use mouse or the **Down** and **Up** keys in drop-down box (parameters that have only a few possible options), or keyboard for text box entry.

Description of Options and Parameters:

### EM61-MK2 Mode

This option allows you to select the type of instrument used. In the drop-down list box select Standard for the EM61-MK2 or High Power if EM61-MK2 High Power (HP) modification is used.

Set the EM61-MK2 mode of operation by selecting an item from the drop-down listbox labeled EM61 Mode. Available modes are: Auto, Wheel, and Manual. These modes of operation are described below.

#### Auto Mode

Readings will be triggered automatically at a specified frequency (see option Readings/s).

Please note that while in the former data acquisition system (DAS70) Stn Increment (station increment) had only two options: Positive or Negative, in the current program this value is optional.

#### Wheel Mode

Readings will be triggered automatically by a counter attached to the wheel. Wheel increment is approximately 20 cm (or 0.64 foot) for the EM61-MK2 equipped with 1 x 0.5 m or 1 x 1 m antennas. The Hand Held EM61HH-MK2 has two

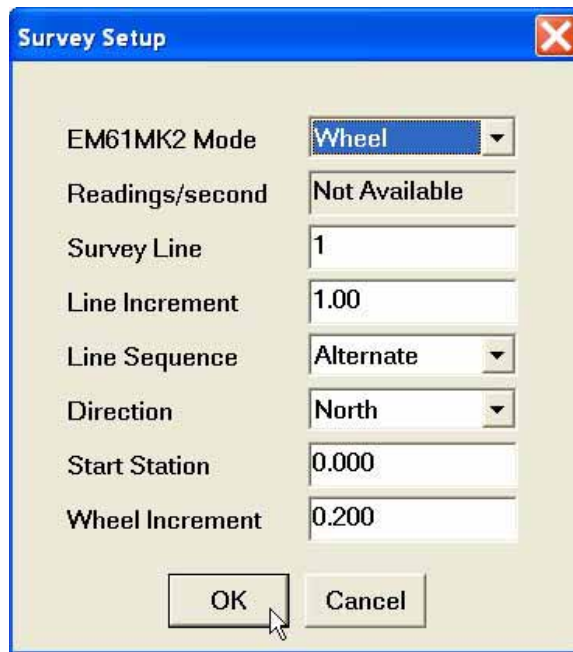

wheel increments 0.1 and 0.2 m. Check the wheel increment setting on the antenna assembly.

When Wheel mode is selected option Reading/second is not available, see figure below. Please note that while in former data acquisition system (DAS70) Stn Increment (station increment) had only two options: Positive or Negative, in the current program this parameter is optional and its value has to be entered according to used wheel increment.

#### Manual Mode

Readings will be taken only while the manual trigger (switch on the logger cable) is pressed. This mode may be used only in very specific applications since the highly dynamic EM61-MK2 response requires finely spaced data points.

Please note that when Manual mode is selected option Reading/second is not available.

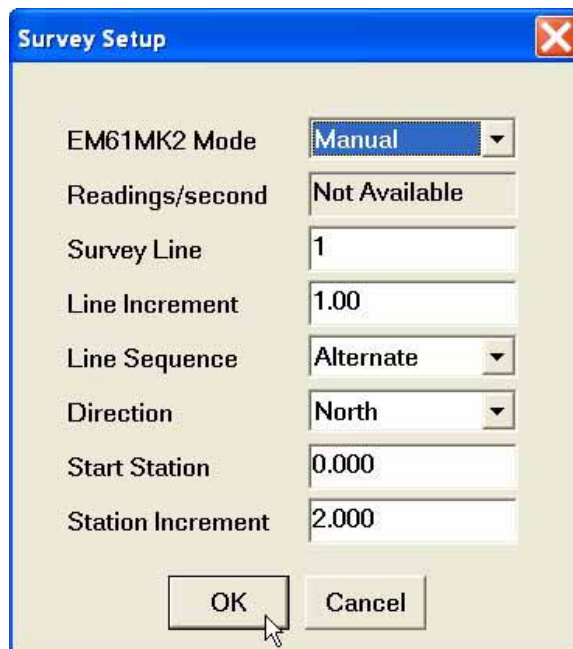

### Readings/second

When this option is available (only in Auto mode) activate text box by clicking with a mouse or using TAB key and then enter desired value.

This parameter describes number of readings per second that will be taken. Any number larger than zero can be entered, however the EM61-MK2 maximum frequency of data output is 17 readings per second.

### Survey Line (survey line name)

Activate text box by clicking with a mouse left button or using TAB key and then enter desired name (number) for the survey line.

This is a user's tag number/name for the profile line. The length of the name can not exceed 8 characters. The line name is usually used as a coordinate perpendicular to the survey lines direction. For example, when survey lines are laid out along W-E direction stations describe W-E coordinate, while Line names may describe S-N (vertical on a map) coordinate.

### Line Incr. (survey line name)

Activate text box by clicking with a mouse or using TAB key and then enter desired for the survey line increment.

This parameter specifies the distance by which survey lines will be separated. This setting will be used to determine number (name) of the next survey line.

### Sequence

When this option is highlighted and drop-down box is expanded use mouse or use **Down** or **Up** cursor key to toggle between two available settings: Alternate and One Way.

EM61MK2 Mode	Auto
Readings/second	5.00
Survey Line	1
Line Increment	1.00
Line Sequence	Alternate
Direction	Alternate One Way
Start Station	0.000
Station Increment	1.000

Alternate is used when neighboring lines are surveyed in the opposite direction, which is the most common procedure during field surveys.

One Way is used when each survey line is traversed in the same direction.

The choice of this parameter will affect the default start station, a signature of the station increment, and line direction when parameters for the next survey lines is determined.

## Direction

Clicking on the down arrow next to the text box opens a drop-down box showing the available options, or when the keyboard is used activate the text box and then by using up or down arrow keys select one of four available settings: East, West, South, and North.

This parameter indicates the heading of the survey line.

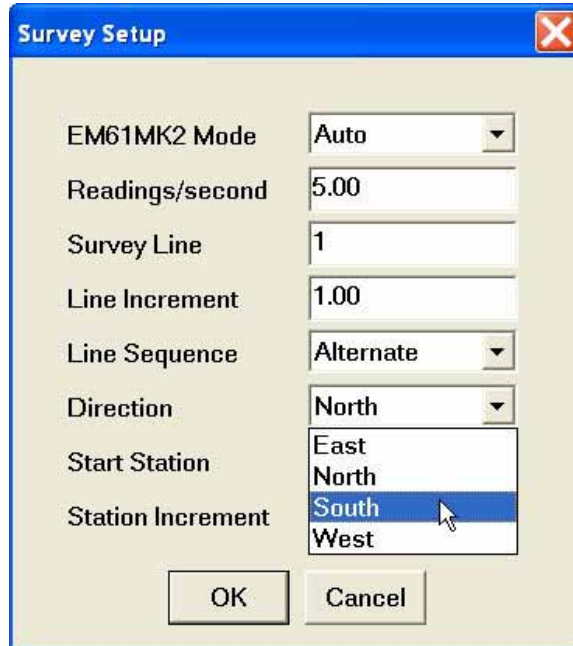

## Start Station (start station of a survey line)

Activate text box by clicking or using **TAB** key and then enter the desired value for the start station.

This parameter specifies the starting station number for the selected survey line. This value is used in conjunction with Station Increment to calculate the current station number for display purposes.

## Stn Increment (station increment)

Activate text box by clicking with a mouse or using **TAB** key and then enter the desired value for the station increment.

This parameter specifies the station increment for the selected survey line. This value is used in conjunction with Start Station to calculate the current station number for display purposes.

After all the parameters in the Survey Setup dialog are updated click on the button **OK** or press **ENTER** key to accept the displayed settings. The program will return to the Main Screen. Updated settings will be written to the initial file and they will be given as default parameters in the subsequent Survey Setup dialog.

To return to original settings (state before this dialog was selected) click on the **Cancel** (X) button or press **Esc** key. All parameters will be reset to initial settings and the program will return to the Main Screen.

### 3. System Setup

This dialog allows you to specify used type of the instrument, EM61-MK2 antenna size and set several parameters in the logging program. The System Setup dialog is presented below.



Description of Parameters:

#### EM61-MK2

This option allows you to select type of used instrument. In the drop-down list box select Standard for the EM61-MK2 or High Power if EM61-MK2 High Power (HP) modification is used.

#### Sensor Size

The Sensor Size option allows you to select the size of the EM61-MK2 sensor. If the EM61HH-MK2 Hand Held antenna is used this option can be ignored. If the standard antennas are used (1 x 0.5 m, 1 x 1 m, or 0.5 x 0.5 m) the size of the sensor must be speci-

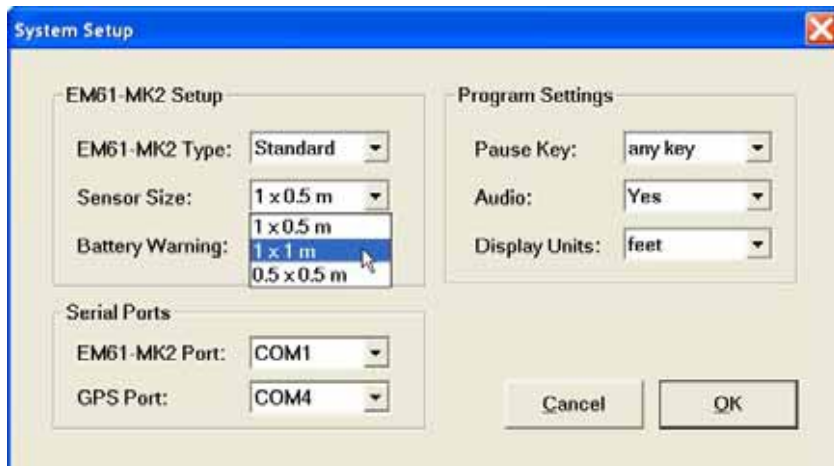



fied before monitoring the instrument output. Select proper size of the EM61-MK2 sensor in the drop-down list box labeled Sensor Size.

### Battery Warning

Specify instrument battery warning level. When the EM61-MK2 battery voltage will reach and drop below specified value the program will display battery voltage on the red background.

### EM61 Port

The number of serial port that is assigned to the EM61-MK2. Available selections: COM1 to COM12. The program default is COM1. Communication parameters for the selected serial port are set by the program, since the EM61-MK2 operates at fixed settings: Baud Rate (9600), Parity (N), Data Bits (8), and Bit Stop (1).

This port must be different than the port specified in the list box "GPS Port:" (see below) or in the GPS Port Setup dialog window (see chapter 4), otherwise a message will be displayed and ports will have to be reassigned.

Select port number in the drop-down list box (see Figure below).

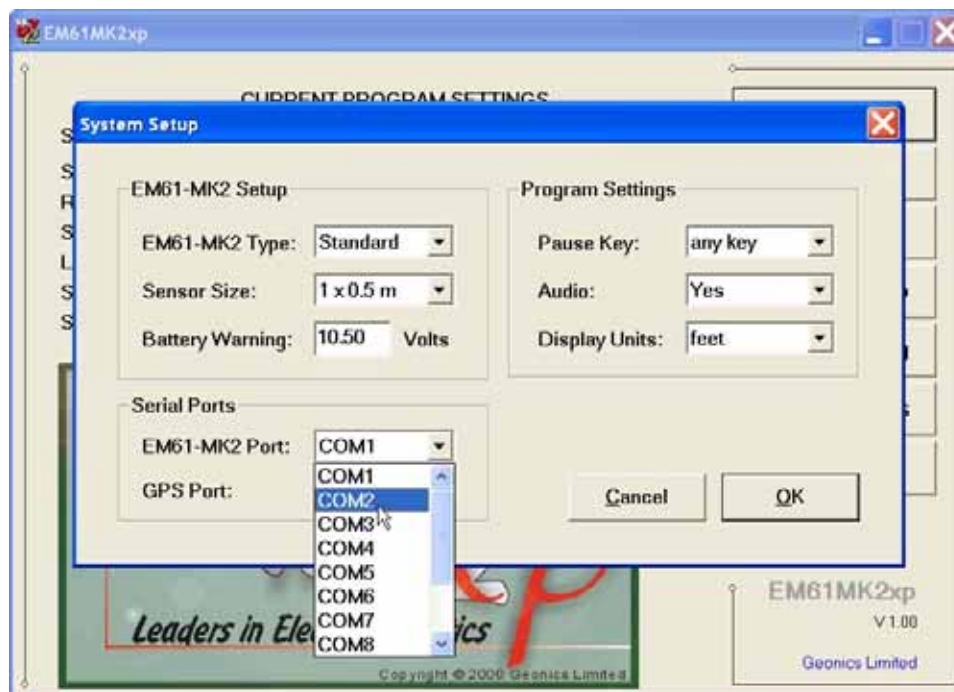

### GPS Port

The number of serial port that is assigned to the GPS receiver. Available selections: COM1 to COM12. The program default is COM2. Communication parameters for the selected serial port can be set in GPS Port Setup dialog. The GPS port can be also assigned in the latter dialog.

This port must be different than the port specified as the EM61-MK2 serial port.

Select port number in the drop-down list box similarly to EM61-MK2 port assignment procedure.

### Pause key

Four selections are available: **any key**, **Space Bar**, **Enter**, and **P**. This feature is used to pause data recording during logging session. Default setting **any key** can be changed to

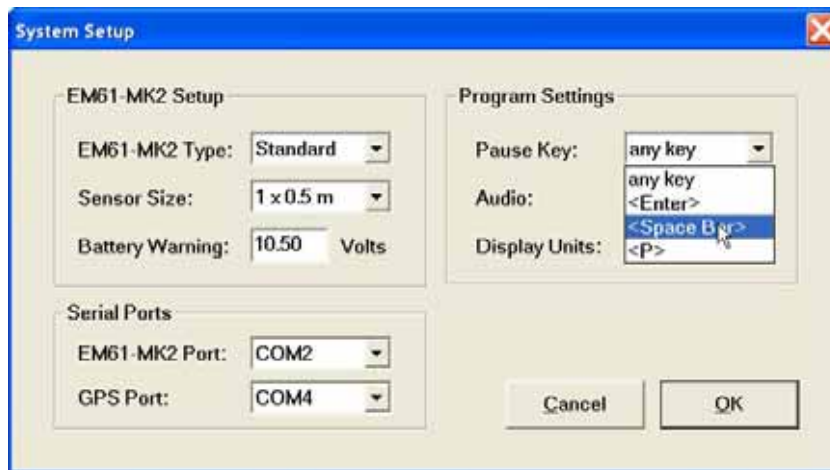

one of the three specific keys for field conditions where a logger key can be accidentally pushed causing unwanted stop of data logging.

#### **Audio**

Two selections are available: **Yes** or **No**. The audible click will be generated at each reading when this option is enabled. At fast rate (above 5 readings/s) the sound may appear not uniform, however this does not affect quality of data acquisition.

#### **Display Units**

Three selections are available: **Meters**, **Feet** or **US Survey Feet**.

After all the parameters in the System Setup dialog are updated click on the button **OK** or press **ENTER** key to accept the displayed settings. The program will return to the Main Screen. Updated settings will be written to the initial file and they will be given as default parameters in the subsequent System Setup dialog.

To return to original settings (state before this dialog was selected) click on the **Cancel** (or window X) button or press **Esc** key. All parameters will be reset to initial settings and the program will return to the Main Screen.



---

## 4. GPS Port Setup & Monitoring

The GPS Port Setup dialog allows for enabling GPS input, and setting communication parameters for serial port associated with GPS input. GPS Monitoring window allows you monitoring the GPS output in terminal mode and to send NMEA commands to GPS receivers.

### 4.1 GPS Port Setup

After the Set Port for GPS button was clicked on (or executed from the keyboard) in the Main Screen the Set Port for GPS dialog window appears on the screen. This dialog allows you to enable and disable the GPS input, select serial port for GPS input, and to specify serial communication parameters matching GPS receiver settings. The dialog is presented below.

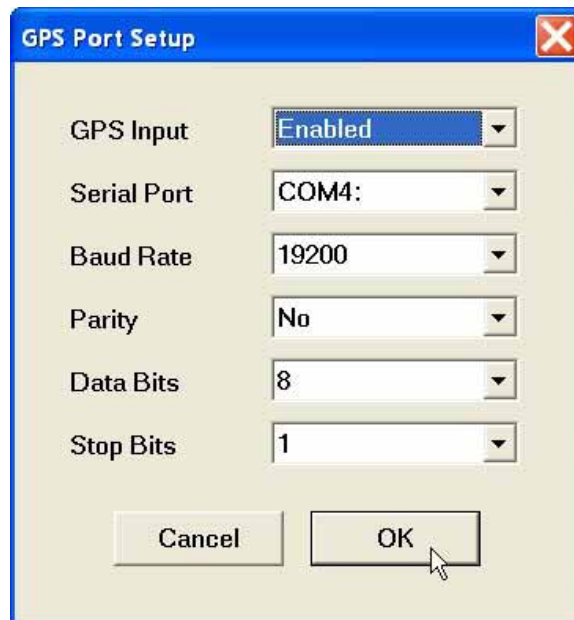

Description of Options and Parameters:

#### **GPS Input**

This option allows you to Enable/Disable a serial port for GPS input. When Disabled is chosen logging and monitoring screens will display message “GPS disabled” in place of GPS parameters.

The GPS Input can be Enabled even if there is no GPS system connected to the computer. In such case data file will contain proper sequence of EM61-MK2 readings without any GPS input.

Clicking on the down arrow next to the text box labeled GPS Input opens a drop-down box showing the available settings, or when the keyboard is used activate the text box by pressing TAB key and then by using up or down arrow keys select one of two available items: Enabled and Disabled.

## Serial Port

The number of serial port that is assigned to the GPS input. Available selections: COM1 to COM12. The program default is COM2. Communication parameters for the selected serial port can be determined in options described below.

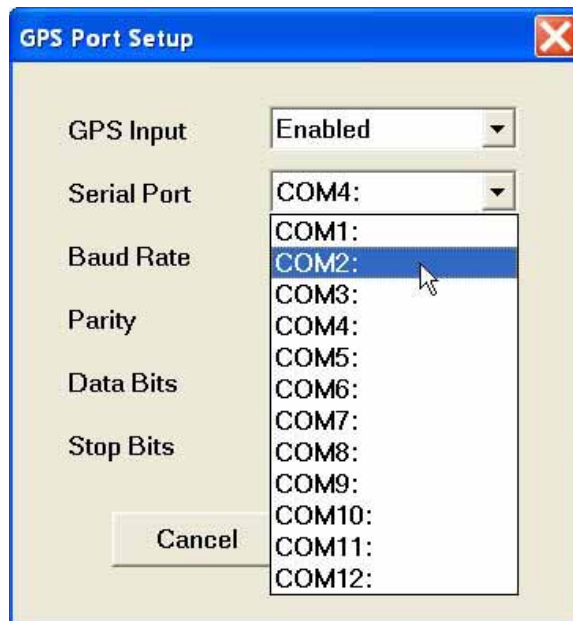

This port must be different than the port specified in the System Setup menu (for EM61-MK2), otherwise a message will be displayed and ports will have to be reassigned.

Clicking on the down arrow next to the text box labeled Serial Port opens a drop-down box showing the available ports, or when the keyboard is used activate the text box by pressing TAB key and then by using up or down arrow keys select one of available items.

## Baud Rate

Specify Baud Rate for the output port, the selected value should match the Baud Rate of the GPS system, default is 9600. Available settings are: 4800, 9600, 19200, 38400, 57600, and 115200.

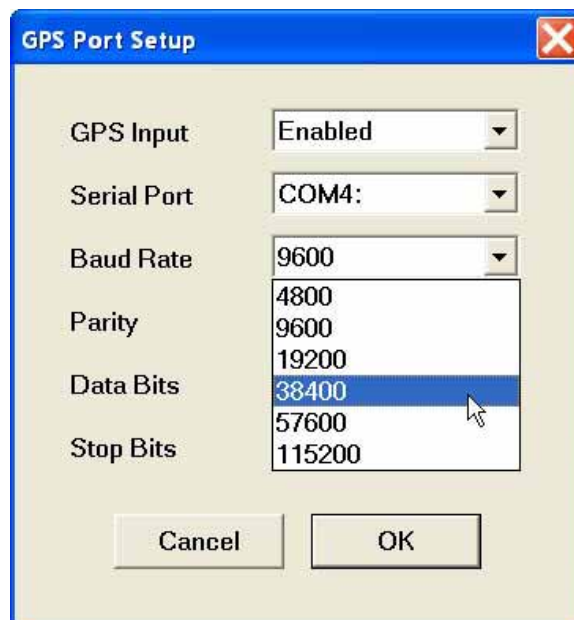

Clicking on the down arrow next to the text box labeled Baud Rate opens a drop-down box showing the available parameters, or when the keyboard is used activate this text box by pressing TAB key and then by using up or down arrow keys select one of available items.

### Parity

Select Parity for the output port, the parameter should match the Parity set in the GPS serial port settings. Available settings are None, Even, and Odd; default is N.

Clicking on the down arrow next to the text box labeled Parity opens a drop-down box showing the available parameters, or when the keyboard is used activate this text box by pressing TAB key and then by using up or down arrow keys select one of available items.

### Data Bits

Specify Data Bits for the output port, the selected value should match settings in the GPS receiver, default is 8. Other available selection is 7.

Clicking on the down arrow next to the text box labeled Data Bits opens a drop-down box showing the available parameters, or when the keyboard is used activate this text box by pressing TAB key and then by using up or down arrow keys select one of available items.

### Stop Bits

Specify Stop Bits for the output port, the selected value should match settings in the GPS receiver, default is 1. Available selections are 1 or 2.

Clicking on the down arrow next to the text box labeled Stop Bits opens a drop-down box showing the available parameters, or when the keyboard is used activate this text box by pressing TAB key and then by using up or down arrow keys select one of available items.

After all the parameters in the GPS Port Setup dialog are updated click on the button **OK** or press **ENTER** key to accept the displayed settings. The program will return to the Main Screen. Updated settings will be written to the initial file and they will be given as default parameters in the subsequent Survey Setup dialog.

To return to original settings (state before this dialog was selected) click on the **Cancel (X)** button or press **Esc** key. All parameters will be reset to initial settings and the dialog window will disappear.

## 4.2 Monitoring GPS Receiver Output

After the Main Screen command button **GPS Monitoring** is clicked or executed by the keyboard the program will display the GPS Monitoring window in terminal mode. In this mode the screen is divided into three parts. The terminal window in the top portion of the screen displays the GPS receiver output. The middle portion labeled NMEA Command is used to display entered NMEA commands previously sent to the GPS receiver, and at the bottom, command buttons with available options (Pause/Go, Send, and Exit) is displayed. These buttons can be clicked on, executed by TAB key and ENTER keys, or by using shortcuts (pressing underlined letter keys). This screen is shown below.

As soon as the EM61MK2xp screen is in terminal mode and the GPS is streaming data, each message transmitted by GPS receiver will appear in the top portion of the display (the end may be cut off if an NMEA message is longer than screen). The display is updated with the frequency the GPS receiver outputs data. This allows you to recognize the GPS update rate and type of messages being sent by the connected GPS. In cases where the GPS data is not received by the logger a message NO DATA and current time will appear in the top window of the display, as shown below.

The message NO DATA is normally updated with a rate of 7 seconds. This may indicate the following: serial port number not correctly specified in Set Port for GPS dialog, GPS receiver not sending any data, and not working or not connected GPS receiver. If the message is updated more often than 7 seconds (i.e. every 1 or 2 seconds) or the display does not show legible characters, it is possible that the GPS is working correctly and is connected to the proper serial port, however communication parameters are not specified correctly. In most cases the Baud Rate or Parity must be adjusted.

The NO DATA message may also appear if the GPS data are received correctly, but the GPS receiver was set to send data with a time interval longer than 7 seconds. In this case the NO DATA message will be displayed in between GPS messages. This indicates that the GPS is working correctly, however the operator should consider adjustment of the GPS receiver output update rate. Most high resolution geophysical surveys require positioning update of 1 or 2 seconds, and a 5 seconds interval can be used only when the survey is carried out at an even pace and along relatively straight survey lines.

The monitoring display can be stopped any time by using button labeled **Pause**. At that time scrolling of the GPS output will be stopped, and the button will be labeled **Go**. The next click (or keyboard



action) on this button will activate receiving and display of GPS data.

The button labeled **Send** allows you to send a NMEA command to the GPS receiver. It is preferable if the GPS receiver parameters are set using the GPS manufacturer software or controller (GPS logger or panel keys). However, **when the operator is familiar with NMEA protocol and structure of commands for a given GPS system**, this function can be very convenient and useful when the update rate and enabling or disabling messages in the data stream is required.

After the button **Send** is clicked a dialog titled GPS Message is displayed and the beginning of the standard NMEA command, **\$PASHS**, or the last entered command is displayed. After the entire NMEA command is typed in, click **OK** button or press the key **<ENTER>** to send the command to the GPS receiver. Clicking the **Cancel** button or pressing the **<Esc>** key will cancel the command and hide the NMEA Message dialog. An example of a command that will enable the NMEA message **SAT** is given in the below figure (it is assumed that the GPS receiver output serial port is A).

After this command is received by the GPS receiver, the confirmation message will be send by the receiver (\$PASHR, ACK\*3D) and data stream will contain the message SAT (\$PASHR, SAT,..... in the above figure).

Please note, that not every GPS system accepts and uses the same standard set of NMEA commands and messages. In addition, some GPS systems do not accept commands sent by the serial port at all. The configuration of these type of receivers can be updated only by the controlling device (usually GPS logger, controller, or the receiver panel keys).





## 5. Display Options

After the **Display Options** button was clicked (or executed from the keyboard) in the Main Screen the Setup Display Options dialog window appears on the screen. This dialog allows you to enable and disable the display of each channel profile, specify color and thickness of profiles, and select linear or compressed amplitude for profiles. The dialog is presented below.

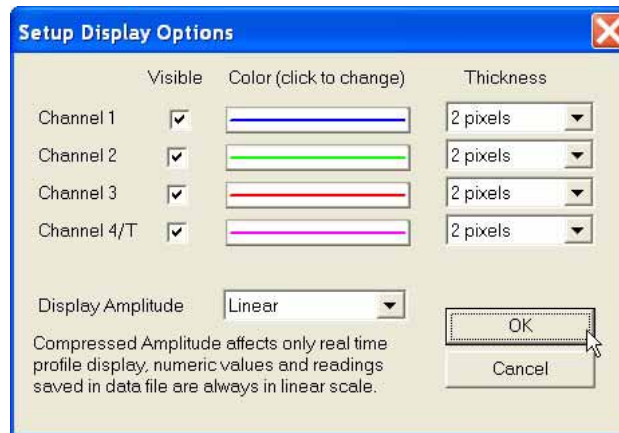

Description of Options and Parameters:

### Visible

To enable or disable displaying of each channel profile click on the corresponding button labeled Visible. Profiles of all channels with checked buttons will be displayed during data logging.

Regardless of which channels are chosen to be displayed as profiles, data for all four channels will be displayed in numeric form below profile display.

### Color

To change colour of each profile click on the corresponding button (with colour line) labeled **Color (click to change)**. The following dialog titled Color will appear.

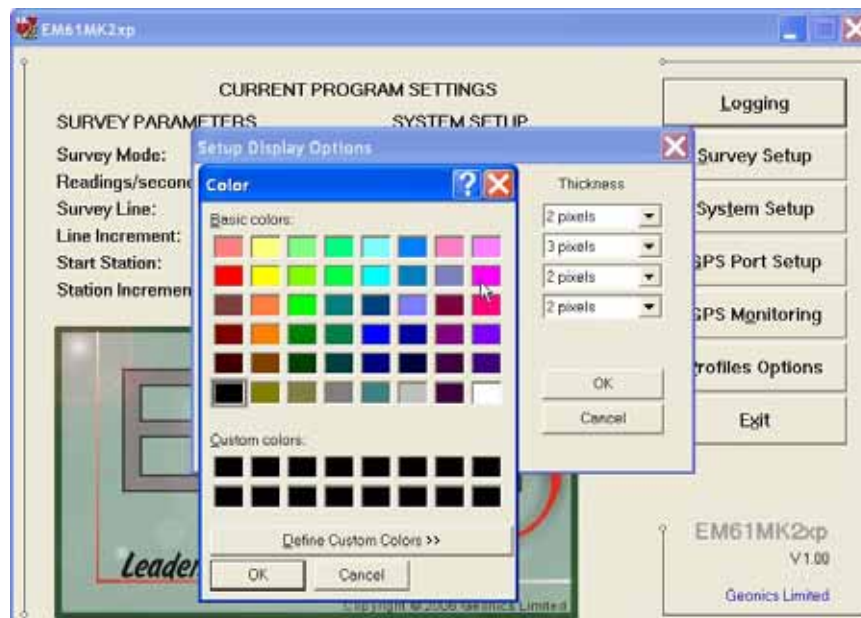

Select desired colour by clicking on a colour box (the selected colour box will be highlighted).

Click on the button **OK** or press **ENTER** key to accept the highlighted colour. The Color dialog will disappear and the colour of the appropriate channel button will updated. To cancel colour selection click **Cancel** (X) button or press **Esc** key.

### Thickness

Specify thickness of a profile for a desired channel by using one of four drop-down boxes labeled thickness. Thickness of a profile curve is expressed in pixels. Available settings are: 1, 2, 3, or 4 pixels.

Clicking on the down arrow next to the text box (labeled by number of pixels) opens a drop-down box showing available selection (see Figure below). Select thickness by clicking on the desired selection. If keyboard is used activate text box by pressing TAB key (till the box is highlighted) and then by using up or down arrow keys select one of available items.

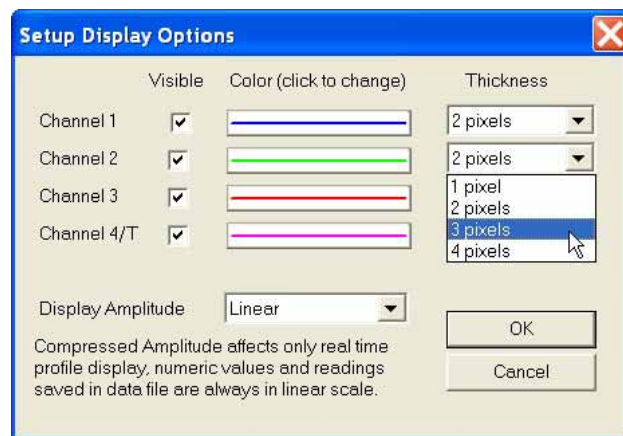

### Profile Amplitude

This option allows you to select Linear or Compressed amplitude scale for profiles. The compressed amplitude (square root function) allows you to display the high dynamic range of the EM61-MK2 data in a legible way and it is recommended.

Clicking on the down arrow next to the text box labeled Profile Amplitude opens a drop-down box showing available parameters, or when keyboard is used activate this text box by pressing TAB key and then by using up or down arrow keys select one of available items.

**Please note, that readings in numeric form are always given in mV (linear scale) regardless of the Profile Amplitude selection. Further, graphic display in the compressed scale does not affect readings saved in the data file. Data are always written to file in original form.**

After all the parameters in the Display Options dialog are updated click the button **OK** or press **ENTER** key to accept the displayed settings. The program will return to the Main Screen. Updated settings will be written to the initial file and they will be given as default parameters in the subsequent Survey Setup dialog.

To return to original settings (state before this dialog was selected) click the **Cancel** (X) button or press **Esc** key. All parameters will be reset to initial settings and the dialog window will disappear.

## 6. Logging Data

After the **Logging** button (in Main Screen) is clicked or executed by the keyboard, the program enters the logging session which contains three modes: Monitoring, Stand By and Logging. The program starts the logging session always in Monitoring mode. In this mode EM61-MK2 readings

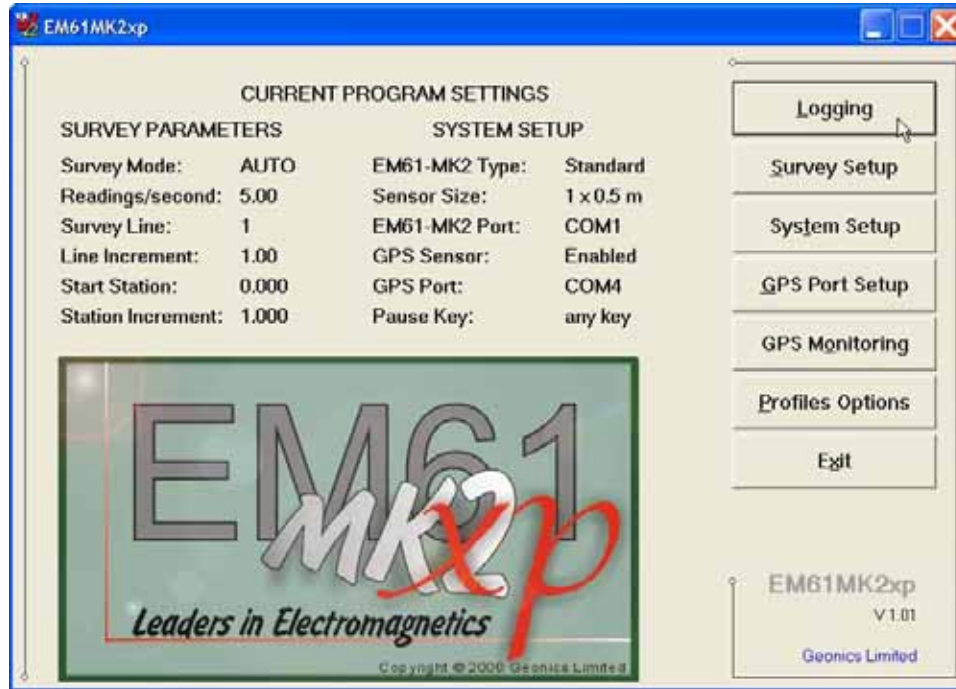

and GPS parameters can be quickly examined and some functions (creating data file, nuling, QC coil check) can be performed. After a data file is created in Monitoring mode, the program switches to Stand By mode and allows access to Logging mode. In Stand By mode instrument output can be monitored and some survey and logging parameters can be changed, and Logging mode is used only to record data. Two modes Stand By and Logging are toggled by **GO** and **Pause** buttons.

### 6.1 Monitoring Mode

The Monitor mode allows initial inspection of the range of the instrument readings at a particular site, monitoring the instrument performance, quick inspection of the condition of the instrument battery, perform QC Coil check, and setting zero level of the instrument.

It is assumed that the instrument is turned ON prior to using this option. If the instrument is OFF or the instrument console is not connected to the computer the following message shown below will appear.

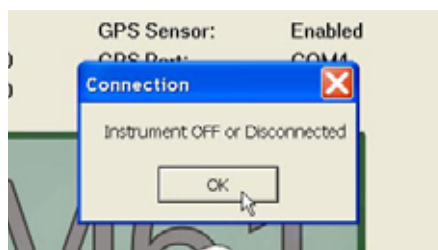

Check the connection or turn the instrument ON and select the Monitor/Log option again.

Assuming that the instrument works properly the program will display the Monitor mode window and will start normalization session which lasts less than 10 seconds. After the normalization is finished the layout of the Monitor window is as follows:

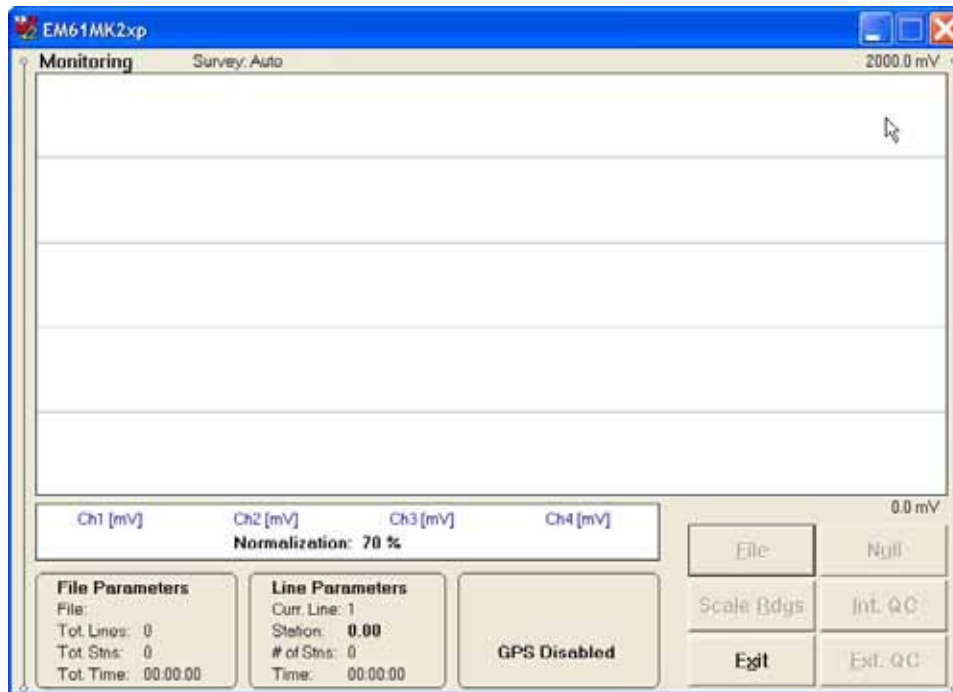

The Monitor (as well as Stand by and Logging) window is divided into five sections.

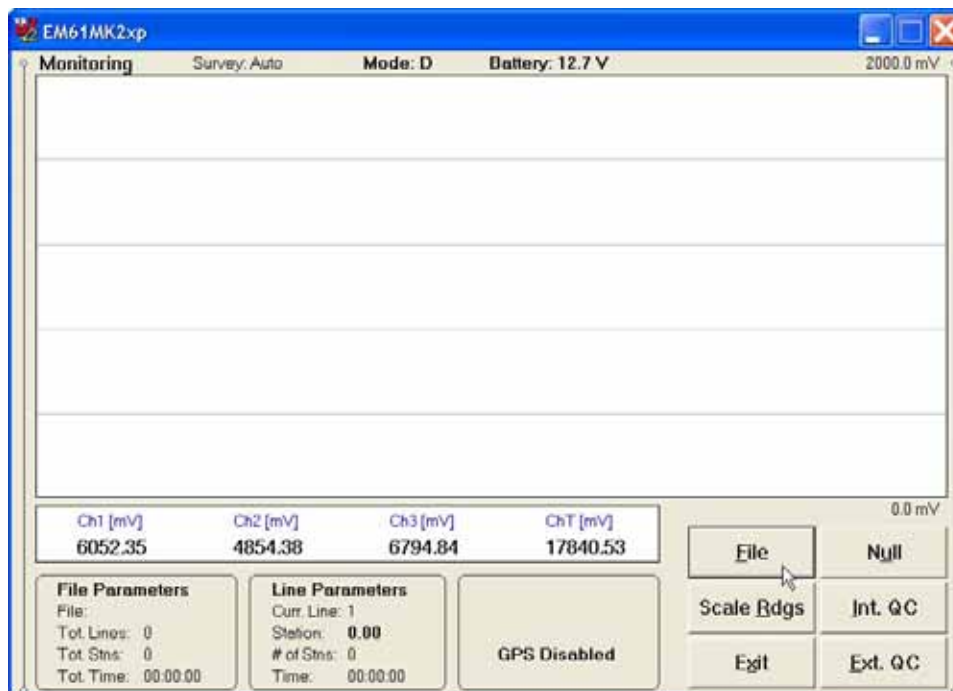

One line of text in the top section provides survey parameters (used in Stand By and Logging modes) and instrument information. In Monitor mode this section displays: instrument mode (4 or D), current display mode (Monitor, Stand By or Logging), Allegro battery level (in % of full charge),

and the EM61-MK2 battery level in Volts (following label **B:**). When fiducial marker is pressed then **M** is displayed.

The second, largest graphic section will be used to display profiles during logging data. Numeric labels on the right side of profile window correspond to scale minimum (below the profile window) and maximum (above the profile window).

The remaining bottom section contains a window with current EM61-MK2 readings, three frames (File Parameters, Line Parameters, and GPS information), and command buttons located on the right side of the screen.

If Mode 4 was selected on the instrument panel (it is displayed at the top of the screen) channels 1, 2, 3, and 4 will be displayed under profile window, and when Mode D was selected (for Top and Bottom antennas) channels 1, 2, 3, and **T** will be given as labels in numeric window. The EM61-MK2 readings are updated approximately 10 times per second during the monitoring session.

When GPS is Disabled in the Set GPS Port dialog a message **GPS Disabled** will be displayed. If the GPS port is Enabled and a working GPS receiver is connected to the field computer the Monitoring screen will display GPS parameters, as presented below.

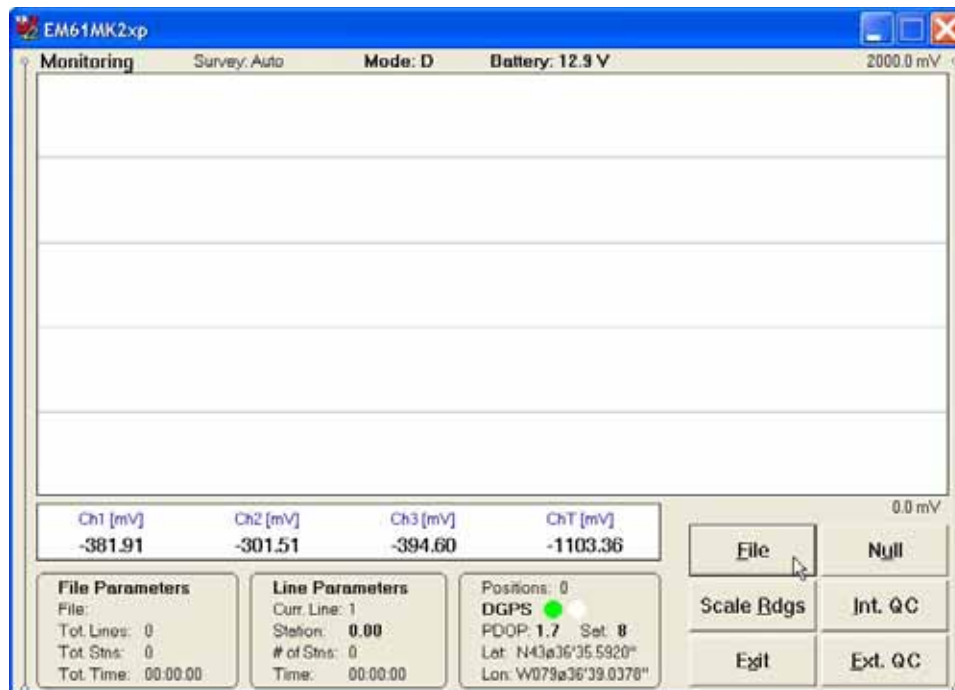

In the above Figure one line of the display is dedicated to show the GPS status. A label **Positions** will be used during data acquisition, it will provide the number of GPS positions saved in the data file. Below, two lines display the parameters describing the quality of GPS positions. A label **DGPS** (Differential Global Positioning System) indicates that GPS readings are differentially corrected in real time, while label **AGPS** (Autonomous Global Positioning System) indicates lack of differential correction. On the right side of **DGPS** or **AGPS** label two green and white circles alternate. These two circles should alternate colours with the frequency of GPS update rate (usually 1 second intervals). If the circles do not change colours for long periods of time it means that the GPS system is not working or that it is not connected to the field computer. The next label **PDOP** with a value varying between 0 and 99.9 represents an index called Position Dilution of Precision (**PDOP**). This value is available only when messages both, GGA and GSA are received from GPS. The last label **Sat** and following number shows number of currently tracked satellites. Refer to section 4 (Set Port for GPS), Appendix B, and to GPS manuals for more information about GPS parameters. Two

bottom lines of the frame give current Latitude and Longitude of the instrument position (datum WGS1984). Position is updated with frequency of GPS receiver stream.

Six command buttons located in the right bottom corner of the Monitor window lists the program functions available directly in the Monitor mode. Available options are as follows: **File** (create data file), **Scale Readings** (change scale for EM61-MK2 readings in profile window), **Exit** (exits the Monitor mode and returns the program to Main Screen, **Null** (perform nulling function), **Int. QC** (internal QC-coi calibration), **Ext. QC** (external QC-coil calibration).

In case of any problems with instrument connection, battery failure, or accidental instrument Turn Off a message "No Communication, trying" will be displayed in numeric values window. The message is highlighted by red background to alert operator as fast as possible. The EM61MK2xp will try to re-establish communication and after the problem is corrected the program will start communication automatically. Alternatively, the Monitor mode can be stopped by clicking on the Exit button or executing this function by a keyboard. The Monitoring window with alerting message is shown below.

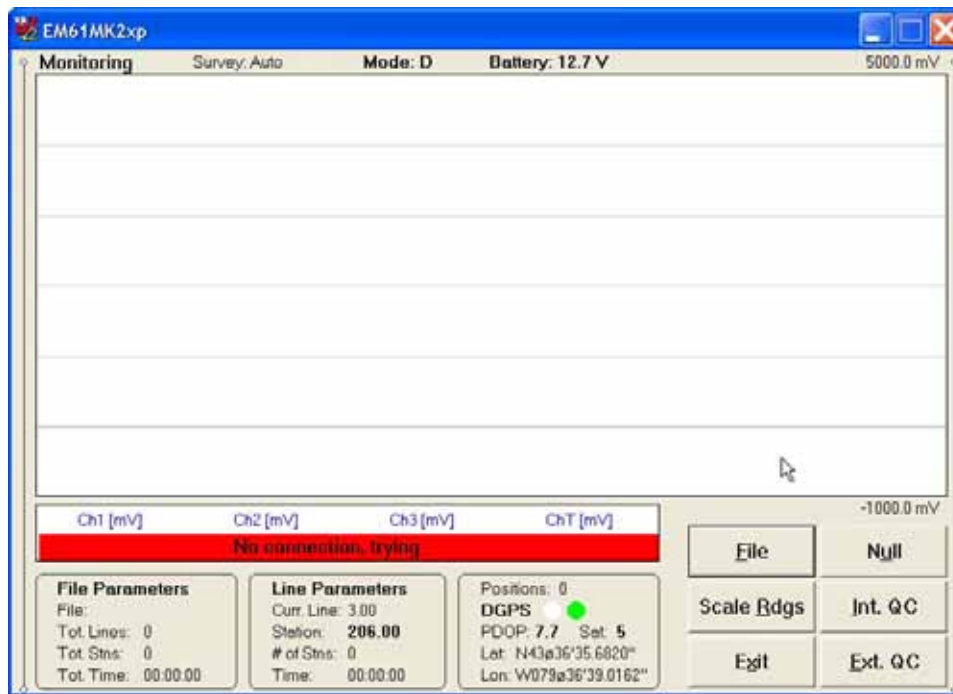

## Description of Monitoring Mode Options

### Cr.File (create data file)

The log data file can be created in any directory. The name of the file is given by the field computer clock and it consists of month (2 digits), day (2 digits), hour (2 digits), and one alphabetic character A, B, C, etc. (If all letters during one hour are used use the Overwrite option). The Create Data File dialog is presented below.

The file name can be specified in the Create Data File dialog using the Windows standard interface procedure. The EM61MK2xp data files cannot be appended.

Each data file in the field computer (raw data file) has an extension name R61 and it is created in the directory specified in Create Data File dialog. The R61 files are created in the

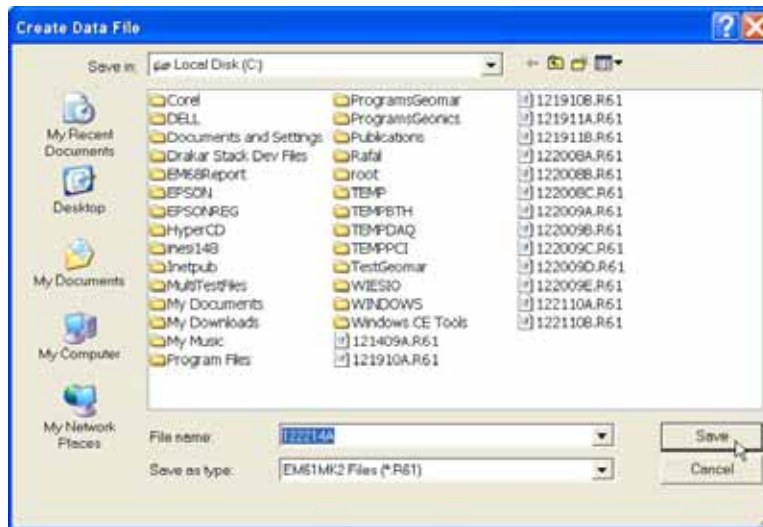

instrument binary format. These files can be also converted to ASCII format and processed in the Geonics DAT61MK2 program.

After the file is specified click on the button **OK** or press **ENTER** key to accept and create data file. The program will switch Monitor mode to Stand By mode and the data file will be displayed on the screen.

To cancel selection and return to Monitoring mode tap the **Cancel** (X) button or press **Esc** key.

## Null

To perform a null of the instrument click on the button labeled **Null** or execute this option using the keyboard (navigate to the button by pressing **TAB** key and when highlighted press **ENTER** key, or use shortcut - press key **U**). At this moment the computer takes 50 readings and calculates the instrument offset.

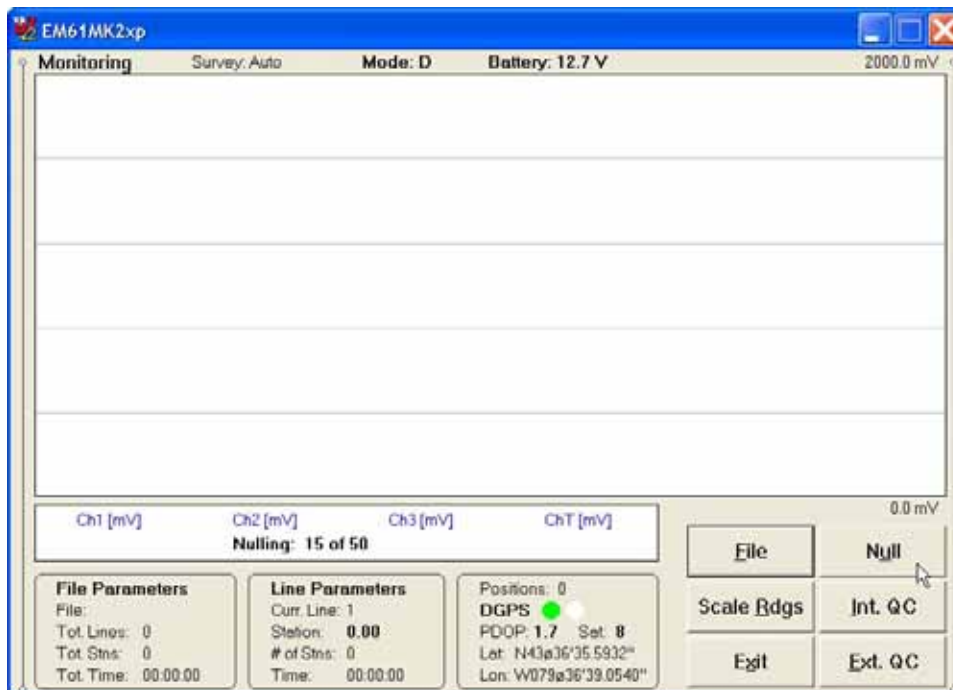



The calculated offset is applied to all the readings that follow this operation. If needed, this procedure can be repeated several times until satisfactory results are obtained. However, there is no associated “Undo” function. If original values (without calculated offsets) of the EM61-MK2 readings are needed, exit the EM61MK2 program and run it again. The EM61-MK2 instrument does not have to be turned OFF. Null operation can be also performed later during data collection.

### Int.QC (*Internal QC Coil Calibration*)

The Internal QC coil calibration is described in detail in the EM61-MK2 Operating Instructions.

To start the calibration using Internal QC coil click on the key labeled **Int. QC** or execute this option by keyboard (navigate to the button by pressing **TAB** key and when highlighted press **ENTER** key, or use shortcut - press key **I**). This action begins by performing the automatic nulling which in this case is only in effect for the duration of the calibration process. It will not affect EM61-MK2 readings. After the nulling is completed (less than 5 seconds) the Internal QC coil Calibration window is displayed. All command buttons in the bottom right corner of logging windows are disabled during Calibration procedure.

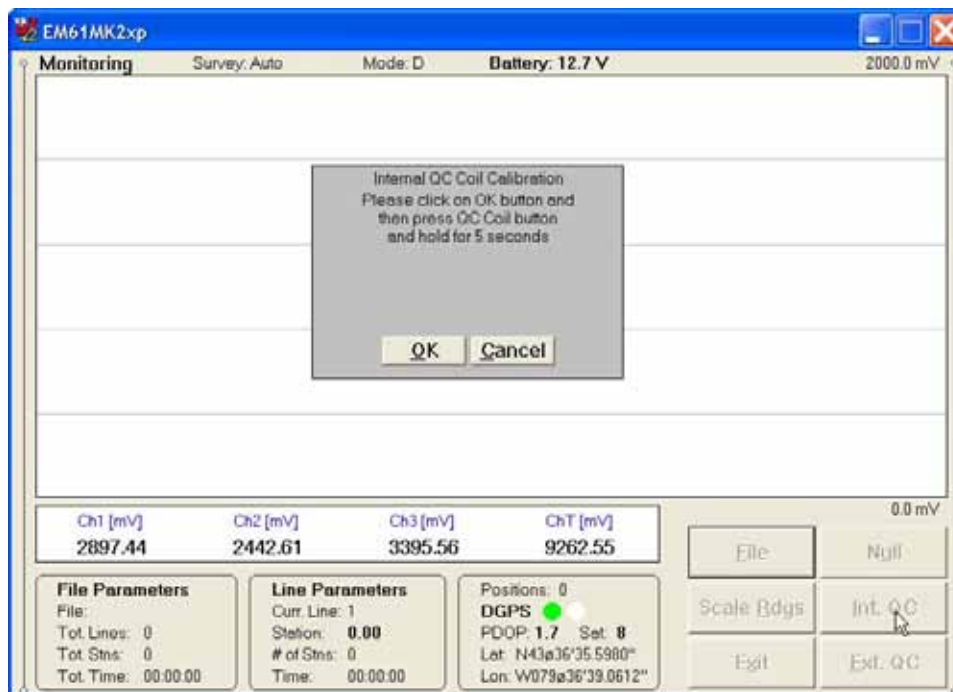

*When Calibration window is displayed please use keyboard keys (O or C) rather than a mouse to execute buttons labeled OK and Cancel. Clicking on buttons by mouse will work, however several mouse button clicks may be required.*

After **OK** button is clicked (or shortcut key **O** is pressed) the window displays timer with elapsed seconds and EM61-MK2 readings. This display lasts for 60 seconds. During this time please follow the instructions provided on the Allegro screen.

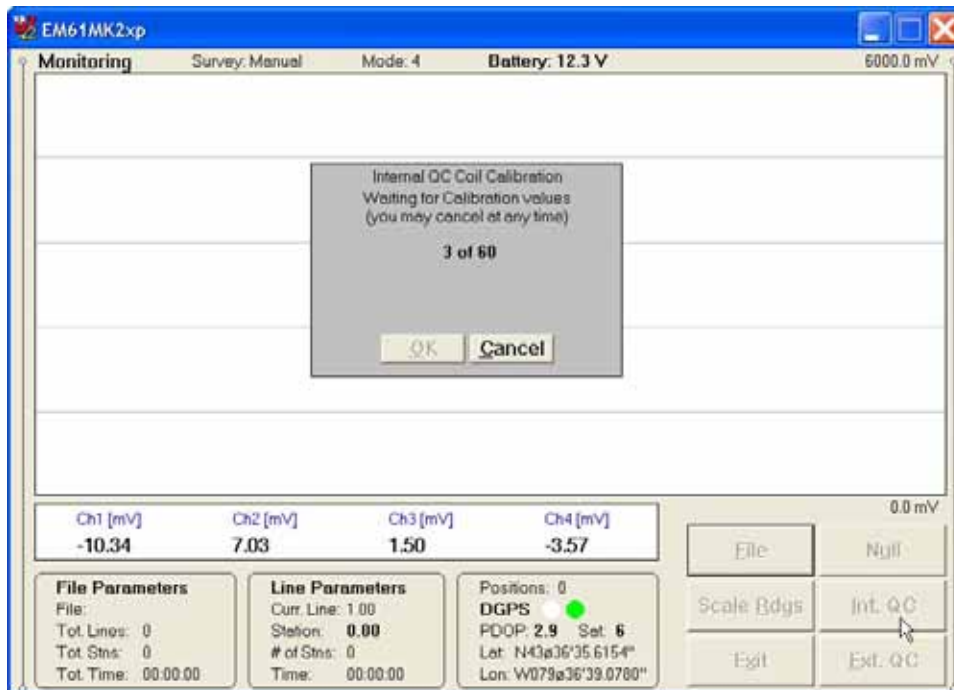

Internal QC coil calibration can end in the following four ways:

The process can be stopped by an operator at any time by clicking on the **Cancel** button or pressing shortcut key **C**.

The calibration may end by time out (60 seconds) if QC coil button was not pressed or this action did not activate QC coil. The following screen will then be displayed:

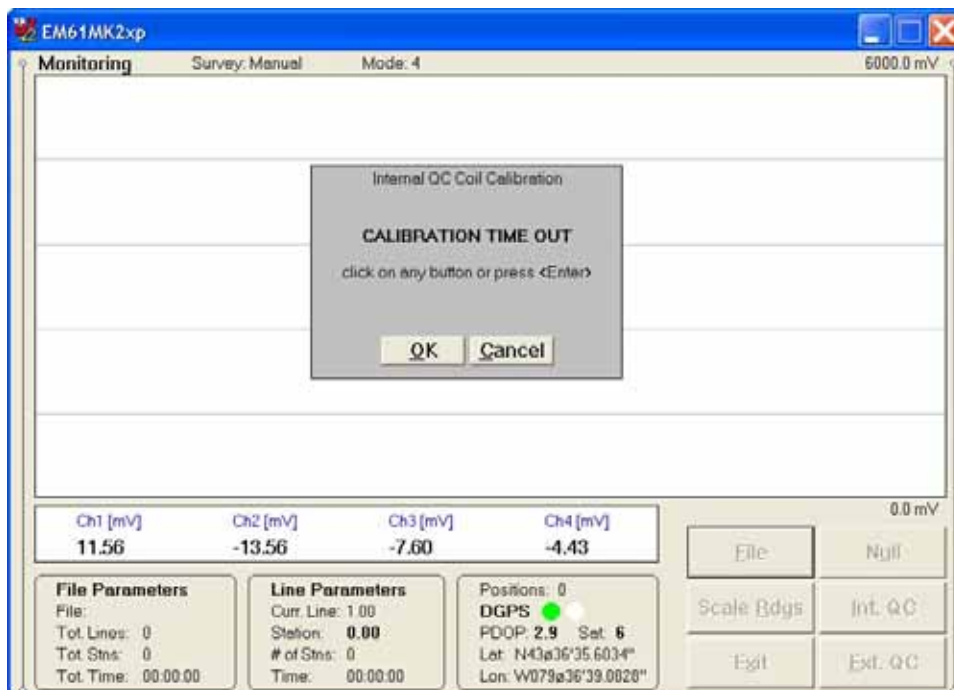

After pressing any key the program returns to Monitoring window. To repeat Internal QC coil calibration please click on the **Int. QC** button again.

The logging program will determine if the instrument has passed test. If after activating the QC coil, the program determines that the reading is inside the standard values within +/- 10% tolerances then a message “CALIBRATION OK” will be displayed (see below).

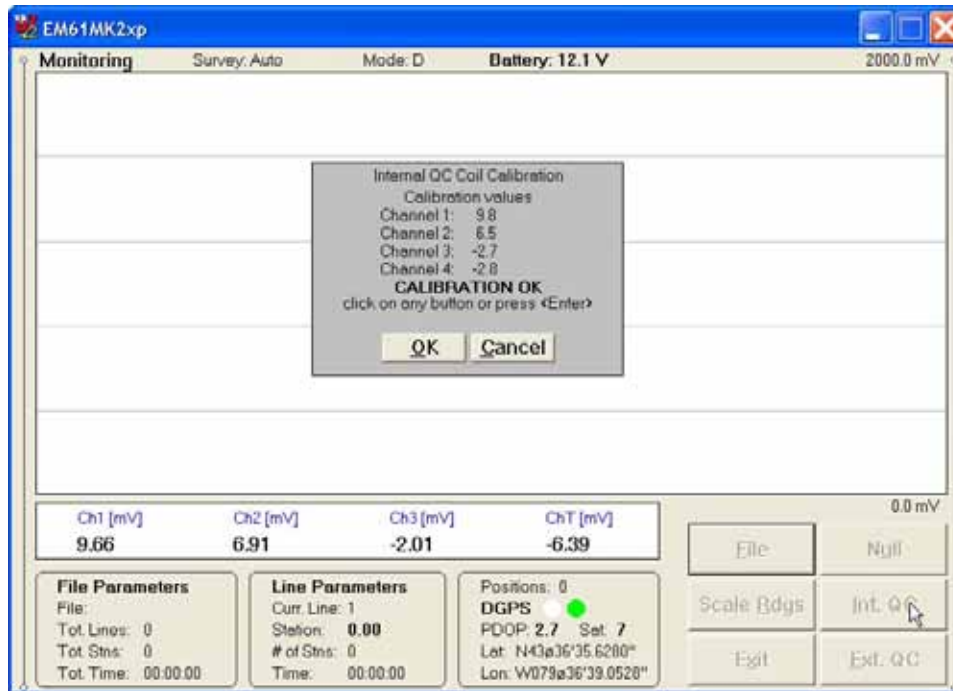

Otherwise, if the program determines that the reading is outside of the test values range the corresponding message “CALIBRATION FAILED” is displayed.

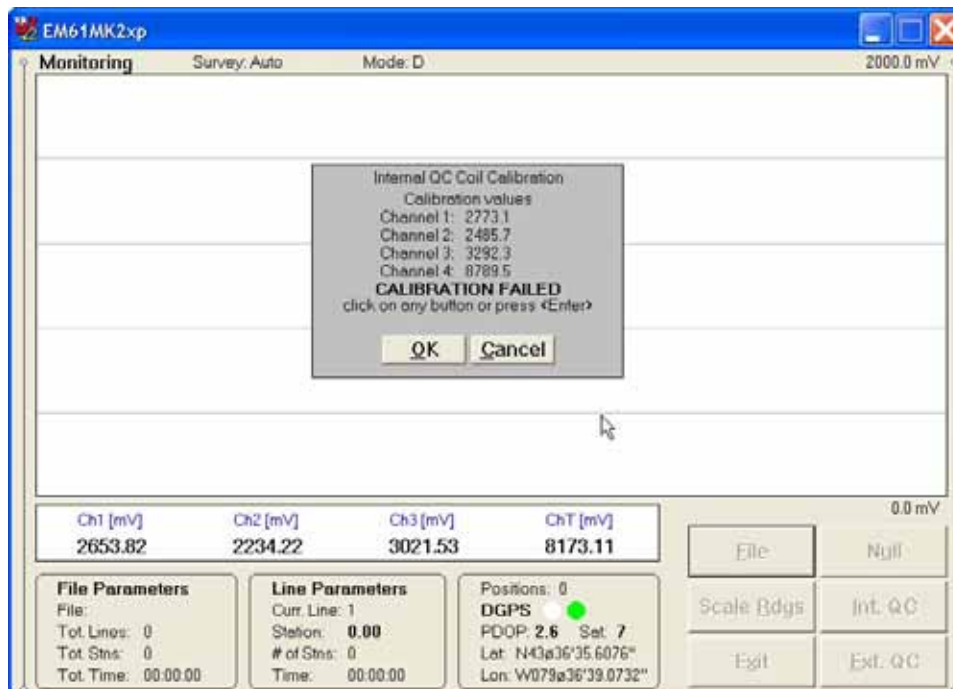

Regardless of the test result (OK or FAILED) the readings will be saved on screen. The program returns to Monitoring window after any button is tapped or ENTER key is pressed. Then the Internal QC coil calibration process can be repeated.

**Ext. QC**      *(External QC Coil Calibration)*

The External QC coil calibration is described in detail in the EM61-MK2 Operating Instructions.

To start the calibration using the External QC coil tap the button labeled **Ext. QC** or execute this option by keyboard (navigate to the button by pressing **TAB** key and when highlighted press **ENTER** key, or use shortcut - press key **E**). This action begins by performing the automatic nulling which in this case is only in effect for the duration of the calibration process. It will not affect EM61-MK2 readings. After the nulling is completed (less than 5 seconds) the External QC coil Calibration window is displayed (Figure below).

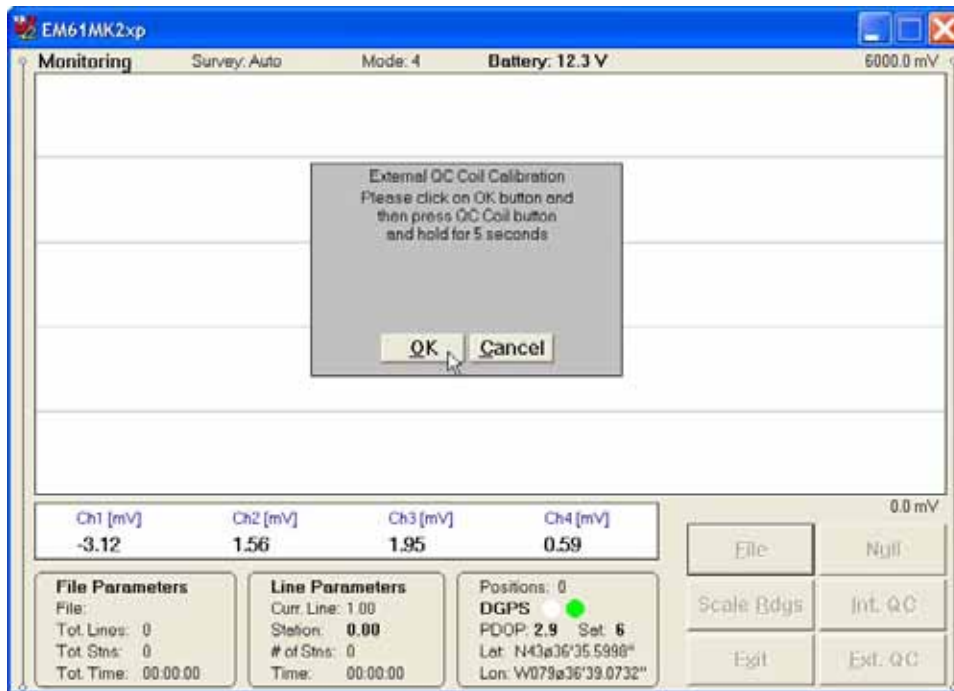

*When Calibration window is displayed please use keyboard keys (O or C) rather than a mouse to execute buttons labeled OK and Cancel. Clicking on buttons by mouse will work, however several mouse button clicks may be required.*

After **OK** button is tapped (or shortcut key **O** is pressed) the window displays timer with elapsed seconds and EM61-MK2 readings. This display lasts for 60 seconds. During this time please follow the instructions provided on the Allegro screen.

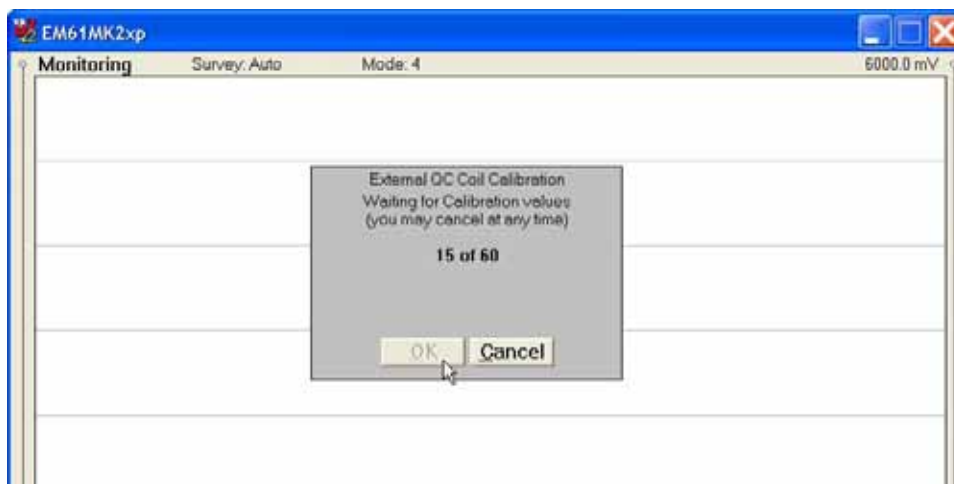

External QC coil calibration can end in the following four ways:

The process can be stopped by an operator at any time by tapping **Cancel** button or pressing shortcut key **C**.

The calibration may end by time out (60 seconds) if the External QC coil button was not pressed or this action did not activate QC coil. The following window will then be displayed (see below).

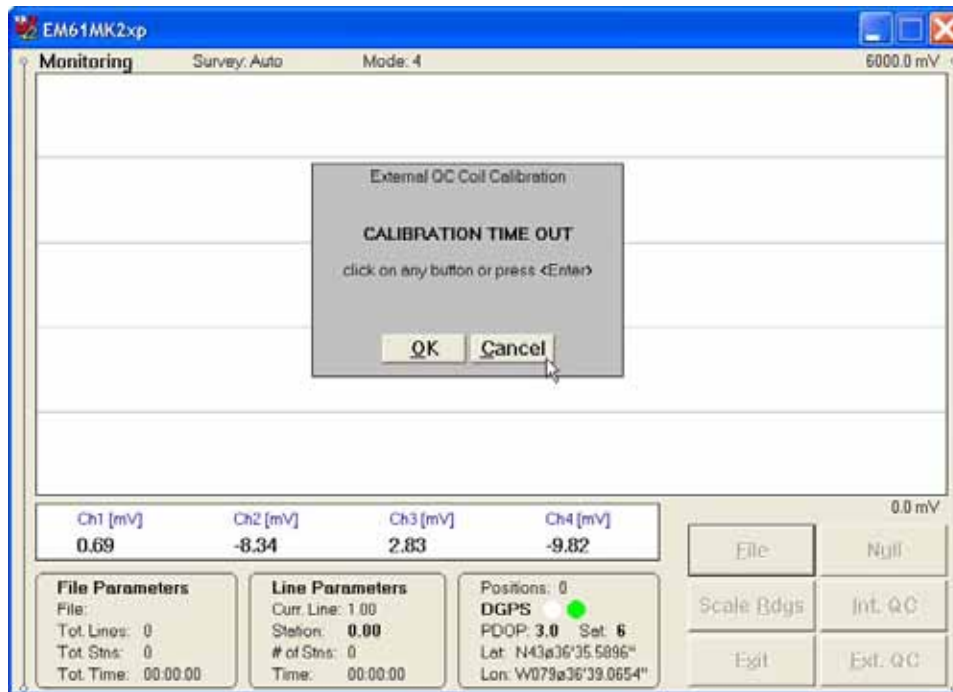

After pressing any key the program returns to Monitoring window. To repeat External QC coil calibration please tap the **Ext. QC.** button again.

The logger will determine if the instrument has passed test. If after activating the QC coil, the program determines that the reading is inside the standard values within +/- 10% tolerances then a message "CALIBRATION OK" will be displayed.

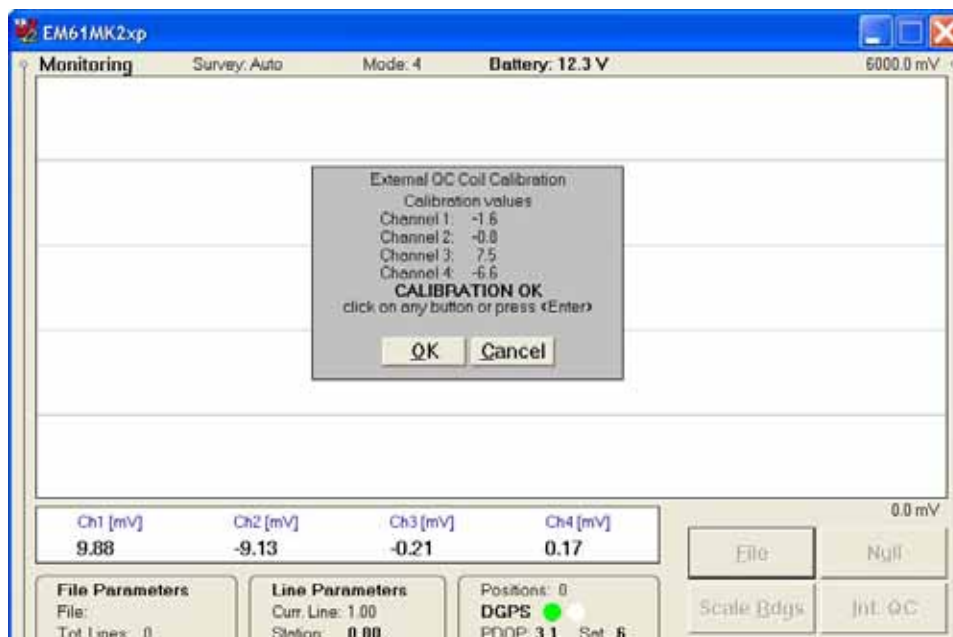

Otherwise, if the program determines that the reading is outside of the test values range the corresponding message “CALIBRATION FAILED” is displayed.

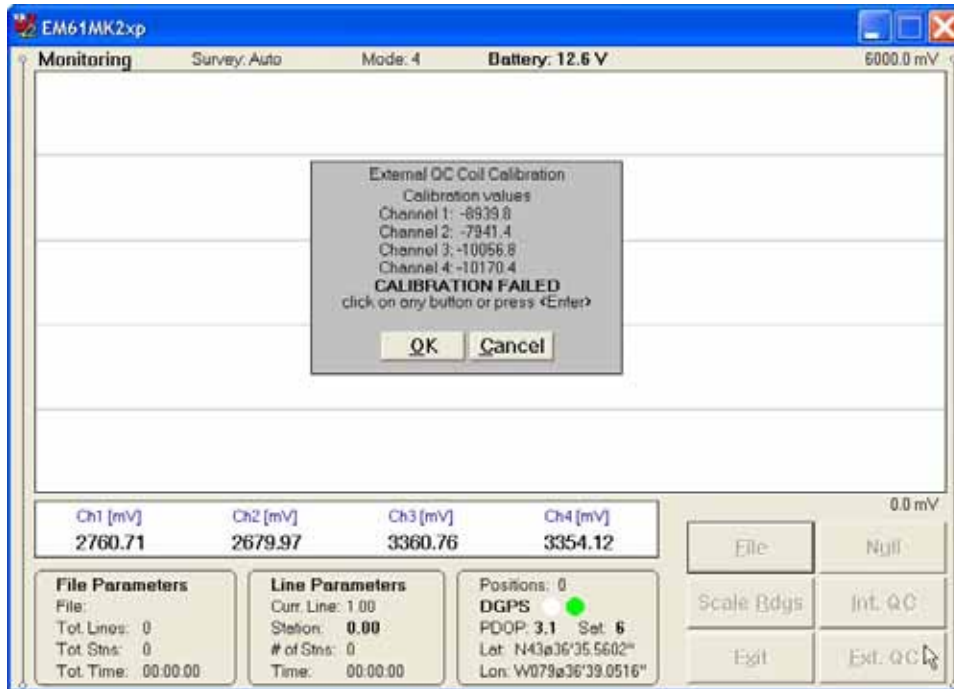

Regardless of the test result (OK or FAILED) the readings will be saved on screen. The program returns to Monitoring window after any button is clicked or ENTER key is pressed. Then the External QC coil calibration process can be repeated.

#### Scale (New Scale for Profile Plot)

Selecting New Scale option allows the operator to enter new scale parameters for the profile plot. This option is available by clicking on the command button labeled Scale Rdgs. or directly from keyboard by using shortcut key <R>.

The Readings Scale dialog will be displayed. It contains two text boxes for Minimum and

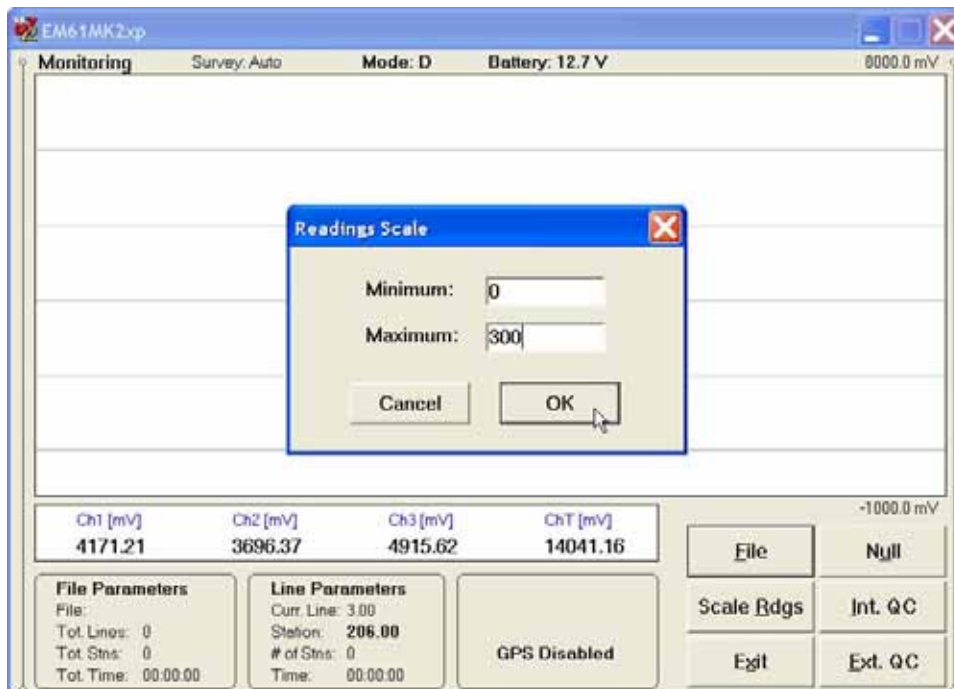

Maximum values of a new scale for profile plot. Current settings (minimum and maximum values) for the scale are displayed in the bottom right and top right corners of the plot area.

After minimum and maximum values are specified click on the button **OK** or press **ENTER** key to accept to accept new values and the profile plot area will be redrawn.

To ignore an entry and return to Stand By mode click on the **Cancel (X)** button or press **Esc** key, the dialog window will disappear and measurements can be continued.

#### **Exit** (exit Monitor mode)

After clicking on the Exit button (or executing this option using keyboard) the program immediately returns to Main Screen.

## 6.2 Stand By Mode

After data file is created in Monitoring mode the program automatically switches logging window to Stand By mode. This windows is similar to Monitor mode however it contains survey parameters (file name, survey line name, etc.) and different set of options represented by buttons displayed at the bottom of the screen. The logging window in Stand By mode in initial state (before any data is recorded) is presented below.

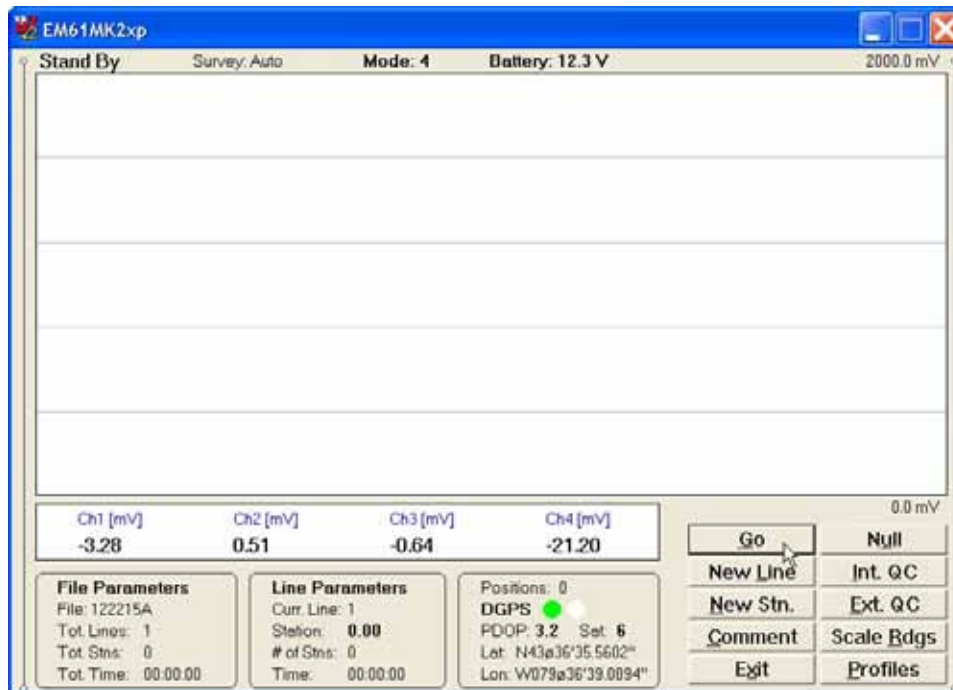

The main portion of the screen is occupied by the plot area which displays profiles (see Figure below which shows Stand By mode after some data were collected). Readings in the plot area can be displayed in compressed amplitude scale, which corresponds to Square Root of the amplitude. In compressed amplitude scale 0 to 100 corresponds to 0 to 10,000 mV, and compressed range 0 to 200 corresponds to 0 to 40,000 mV. Plotting data in compressed amplitude allows you to show details in the low range of amplitude, as well as relatively good resolution in the high range of data on the small screen. **Please note, that data displayed in the numeric form are always given in the standard, linear scale.** The amplitude scale is divided by four or five grey grid lines. In the case where the amplitude scale starts with a negative value, then the grid line corresponding to zero is always plotted as a thicker line.

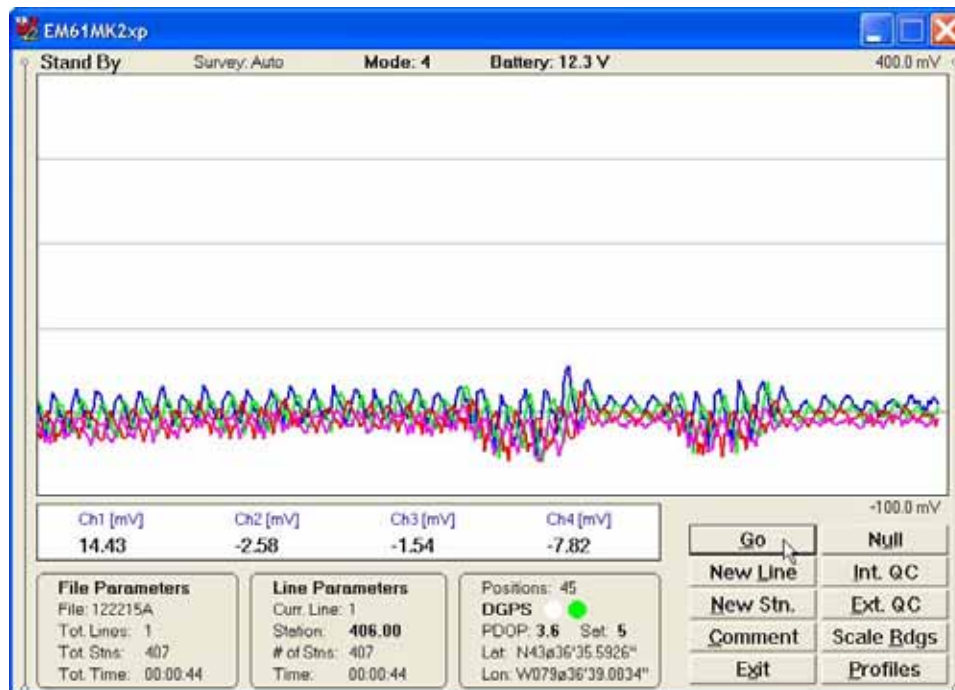

Readings for Channels 1, 2, 3, 4 or T are shown in numeric form in a window below the plot area. Values of readings are labeled: **Ch1**, **Ch2**, **Ch3**, **Ch4** or **ChT**. The program checks instrument mode continuously, therefore label **Ch4** indicates mode **4** while label **ChT** corresponds to instrument mode **D**. EM61-MK2 readings (in numeric form) are updated in Stand By mode approximately 10 times per second. Profiles in the plot area are updated only during Logging mode when data are actually saved in the data file.

A section of the window at the top of the screen contains one line of text displaying survey and instrument related parameters. These are (from top left): logging mode **Stand By** or **Logging**, survey mode (**Auto**, **Wheel** or **Manual**), instrument mode **4** or **D** (labeled Mode:), and EM61-MK2 battery level in Volts (labeled **Battery**). When fiducial marker is active a label **Marker** is displayed in this line.

File and Survey Line parameters, and GPS information are displayed in three framed boxes at the bottom of the Stand By window. File Parameters frame displays: name of the data file, total number of survey lines, total number of stations collected in the file, and total time of surveying. The Line Parameters frame contains: name of current survey line, current station, number of stations in the current survey line, and time of surveying current line. In the Stand By mode the station number will not change. Stations in the EM61MK2xp program are incremented by station increment value after each reading is written to the data file.

The third frame is dedicated to showing the GPS status. A number following the label **Position** provides the number of GPS positions saved in the current data file. In Stand By mode the number of positions is not incremented (it is updated only when GPS position is written to the file). Next two lines in this frame display parameters describing quality of GPS positions. A label **DGPS** (Differential Global Positioning System) indicates that GPS readings are differentially corrected in real time, while label **AGPS** (Autonomous Global Positioning System) indicates lack of differential correction. On the right side of **DGPS** or **AGPS** label two green and white circles alternate. These two circles should alternate colours with the frequency of GPS update rate (usually 1 second intervals). If the circles do not change colours for long periods of time it means that the GPS system is not working or that it is not connected to the field computer. The next label **PDOP** with a value



varying between 0 and 99.9 represents an index called Position Dilution of Precision (**PDOP**). This value is available only when messages both, GGA and GSA are received from GPS. The last label **Sat** and following number shows the number of currently tracked satellites. Two bottom lines of the frame give current Latitude and Longitude of the instrument position (datum WGS1984). Position is updated with frequency of GPS receiver stream.

In case of any problems with instrument connection, battery failure, or accidental instrument Turn Off a message "No Communication, trying" will be displayed in numeric values window. The message is highlighted by red background to alert operator as fast as possible. The EM61MK2xp will try to re-establish communication and after the problem is corrected the program will start communication automatically. Alternatively, click on the Exit button or execute this command from a keyboard. The program window in Stand By mode and the alert message is shown below.

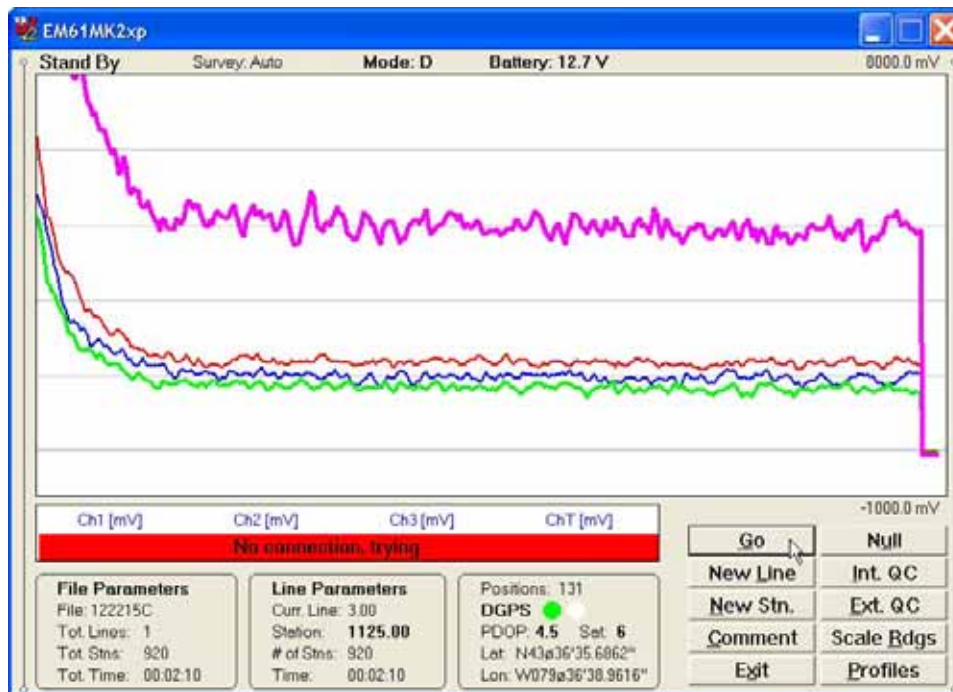

Several available field options (in form of command buttons) are listed at the bottom right corner of the Stand By mode window. They will be described in the following section 6.4.

### 6.3 Logging Mode

The Logging mode is enabled by clicking on the button labeled **GO (log data)** or pressing the shortcut key **G** (or the **<ENTER>** key if button **GO** is highlighted) in Stand By mode. After this button is pressed the list of buttons at bottom of the screen will be replaced by one **PAUSE** button, label Stand By will be replaced by label **Logging** (at the top of the display) and data will be logged in the mode corresponding to the selected EM61-MK2 mode in the Survey Setup menu. All labels and parameters (with the exception of buttons representing Stand By mode options) are the same as in Stand By mode and they are described in the preceding section 6.2. The screen in Logging mode is presented below.

After the screen changes to Logging mode the current station (labeled **Station:**) is updated according to the station interval. Similarly, if GPS Input was enabled, total number of GPS positions (label **Positions**) in the data file is incremented every time (usually once a second) GPS position is written

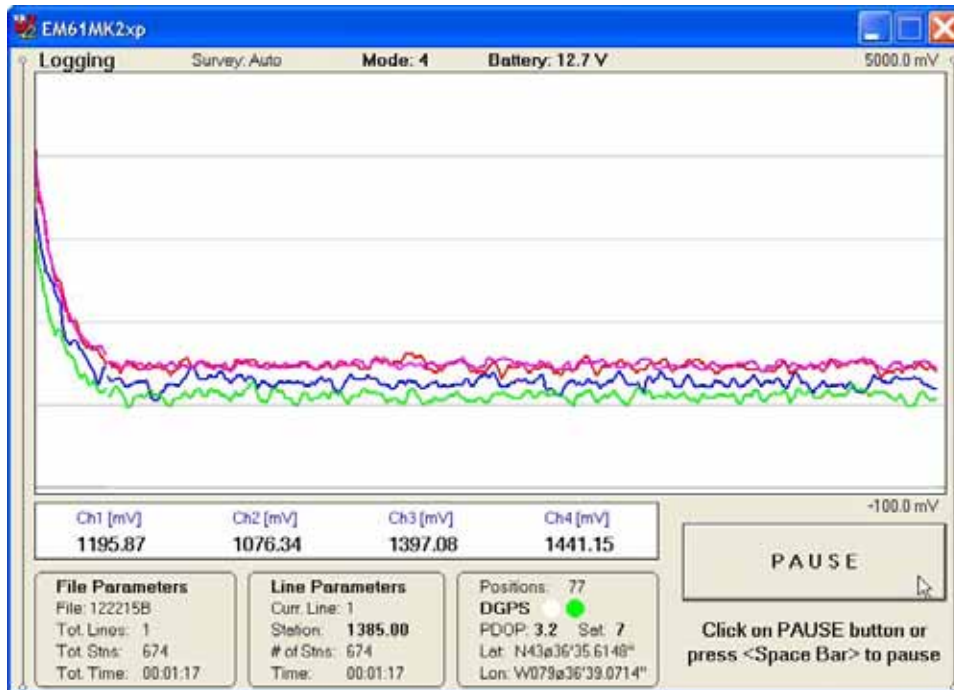

to the file. Profile curves (for channels selected in Display Options window) are updated after each reading is written to the data file.

In case of any problems with instrument connection, battery failure, or accidental instrument Turn Off a message "No Communication, trying" will be displayed in numeric values window. The message is highlighted by red background to alert operator as fast as possible. The EM61MK2xp will stop collecting data and will try to re-establish communication. After the problem is corrected the program will start communication automatically. Alternatively, click on the Pause button to return to Stand By mode. The program window in Stand By mode and the alert message is shown below.

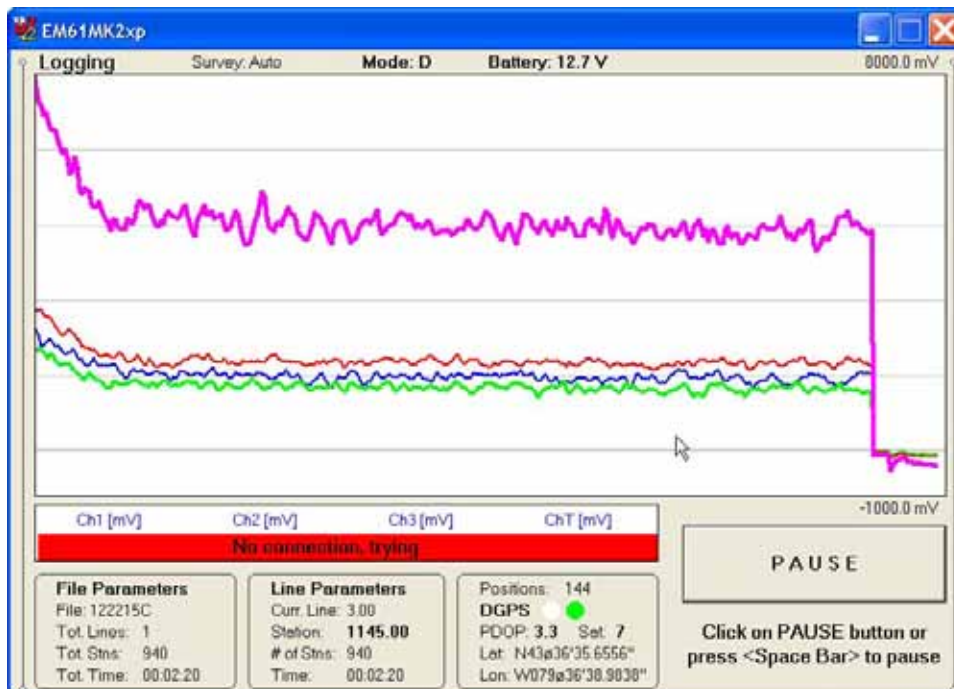

There is only one option available in the Logging mode - pause logging. After a Pause button is clicked or Pause key (any key or other Pause Key selected in Logger Setup window) is pressed the recording is stopped and the Logging mode returns to the Stand By mode. In Stand By mode the EM61-MK2 data will be displayed with the update rate approximately 10 readings per second, however data will not be saved in the log file and profile curves will be not updated.

Exiting from the logging session and access to various field options are available only from the logging window in Stand By mode.

## 6.4 Stand By Mode Field Options

Several field options are available while the Logging window is in the Stand By mode. Options can be accessed directly from command buttons. Command buttons can be used by clicking on the desired button, or from the keyboard by pressing one of the shortcut keys (underlined characters on button labels) or by navigating using <TAB> key (sets button as a default button - default button is highlighted) and pressing <ENTER> key.

### GO (log data) *(start data logging)*

Click on the **GO** button, or while using the keyboard press shortcut key <G> or if the button is a default button (highlighted) press <ENTER>. The logging window in Stand By mode will change to Logging mode and logging data starts immediately.

### New Line *(New Survey Line)*

The New Survey Line dialog is displayed (see Figure below). Selecting this option allows the operator to enter a new survey line number (name) and associated line parameters (Line Increment, Line Sequence, Direction, Start Station, and Station Increment). The new line number and associated parameters are prompted by the program based on parameters specified in the Survey Setup dialog.

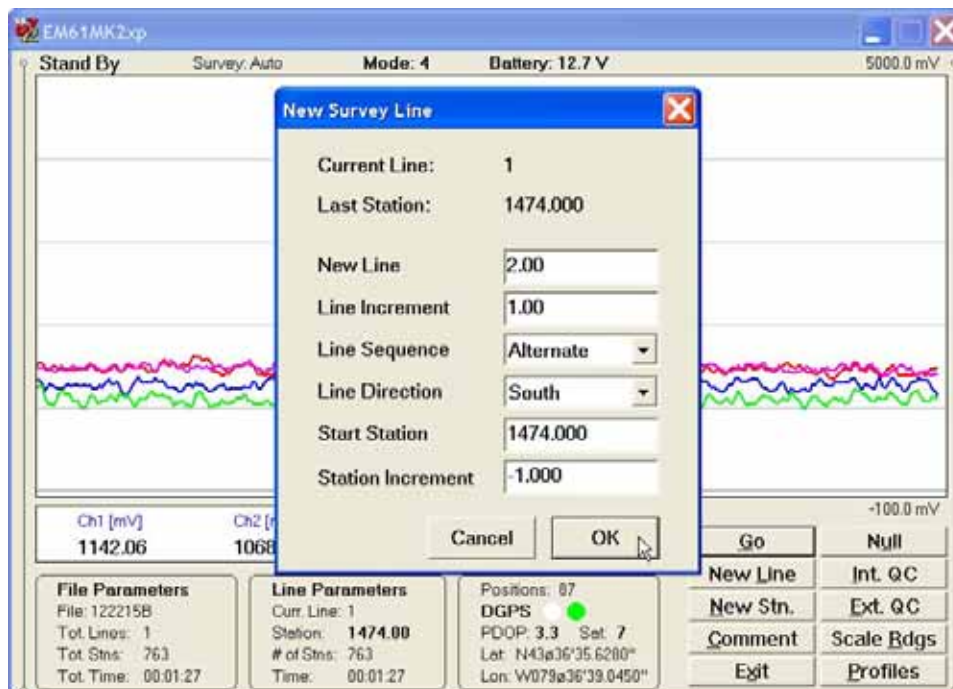

At the top of the dialog the last survey line name and the last logged station are displayed. Default name for the new line is given based on the Line Increment parameter. The default Start Station, direction of the Station Increment, and Direction are determined based on Sequence selection. All these parameters can be overwritten by the user as described in the Survey Setup menu description (chapter 2).

After all the parameters in the New Line dialog are updated click on the button **OK** or press **ENTER** key to accept the displayed settings. The program will return to the Logging window in Stand By mode. Survey line name (**Curr. Line**) name and current station (**Station**) value will be updated and profile curves plot for former survey line will disappear.

To return to Stand By mode and current survey line settings (state before this dialog was selected) click on the **Cancel** (X) button or press **Esc** key.

#### New Stn. (New Station)

Selecting this option allows the operator to enter a new station number (within the same survey line). The New Station dialog is displayed.

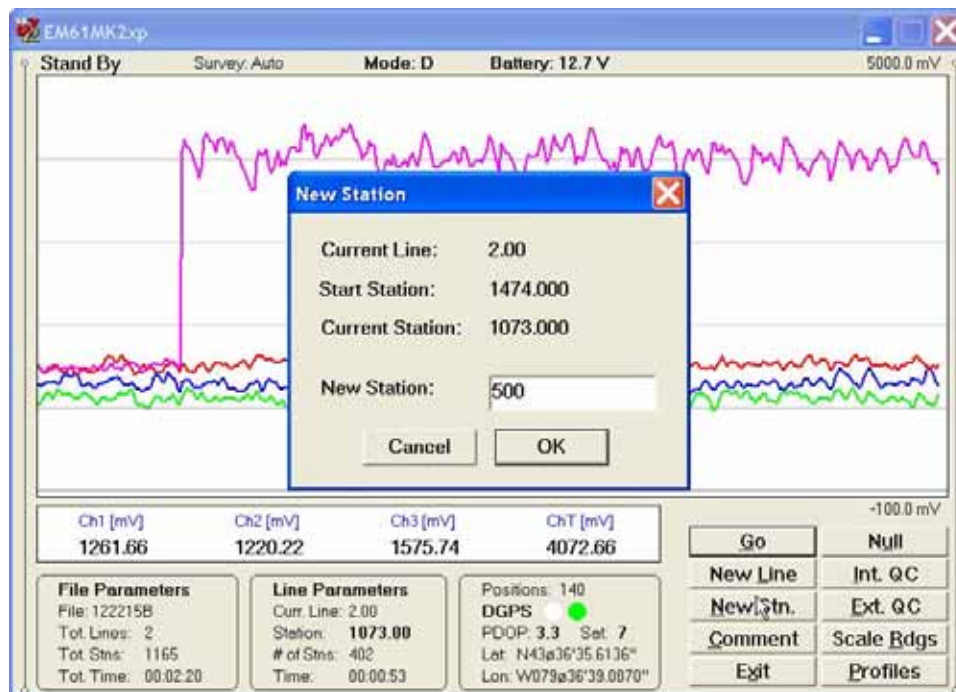

Current survey line, Start and Current station are displayed at the top of the dialog. The New Station can be entered in the provided edit box labeled New Station.

Click on the button **OK** or press **ENTER** key to accept the new value. The program will return to the Logging window in Stand By mode. Current station (**Station**) value will be updated and after data logging is activated the profile curves will have a small gap (two pixels) showing the new station entry (see Figure below).

To return to Stand By mode and current survey line settings (state before this dialog was selected) click on the **Cancel** (X) button or press **Esc** key, the dialog window will disappear and measurements can be continued.

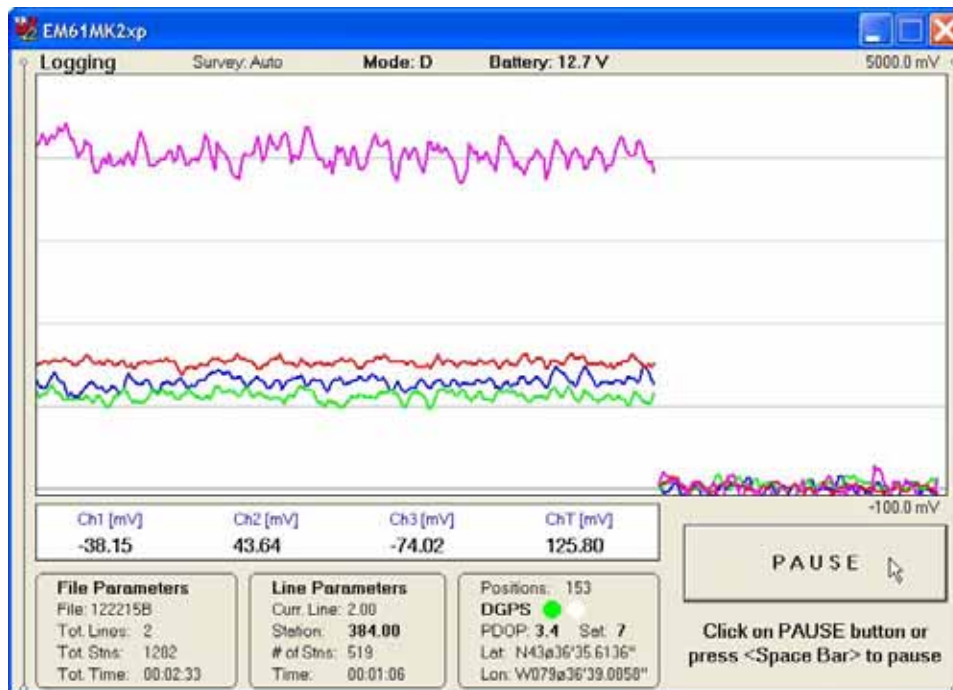

**Comment** (*Field Comment*)

Selecting this option allows the operator to enter a comment at any point of the survey. A maximum of 11 characters can be entered as a comment. The Enter Comment dialog is displayed.

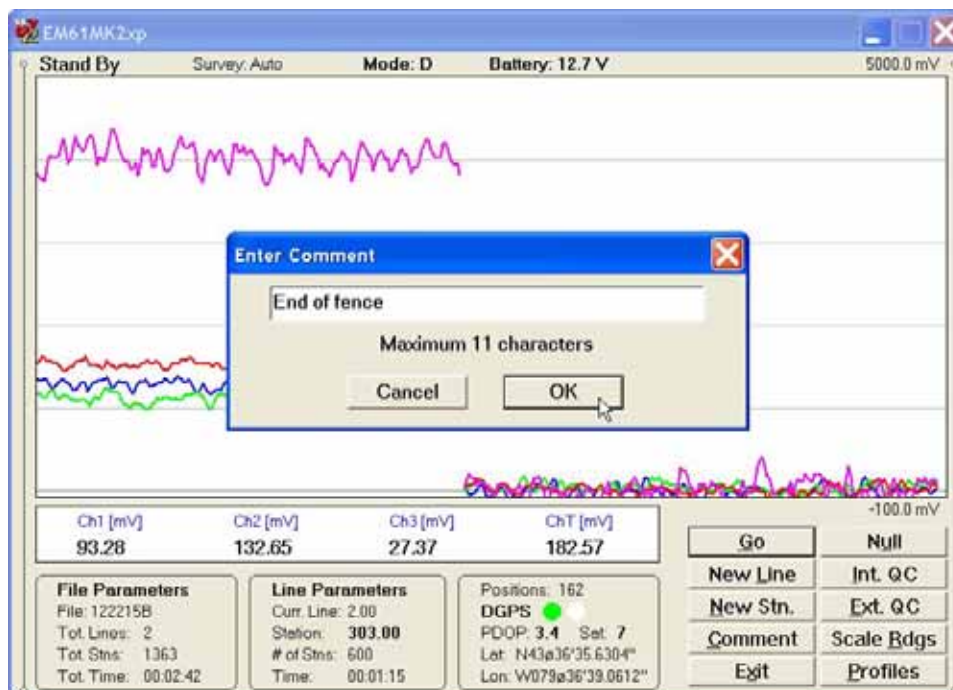

Click on the button **OK** or press **ENTER** key to accept the comment entered in a text box of the dialog. The text of the comment is saved in the file with a corresponding time stamp and the program will return to the Logging window in Stand By mode.

To ignore an entry and return to Stand By mode click on the **Cancel** (X) button or press **Esc** key, the dialog window will disappear and measurements can be continued.

### Scale Rdgs (New Scale for Profile Plot)

Selecting New Scale option allows the operator to enter new scale parameters for the profile plot.

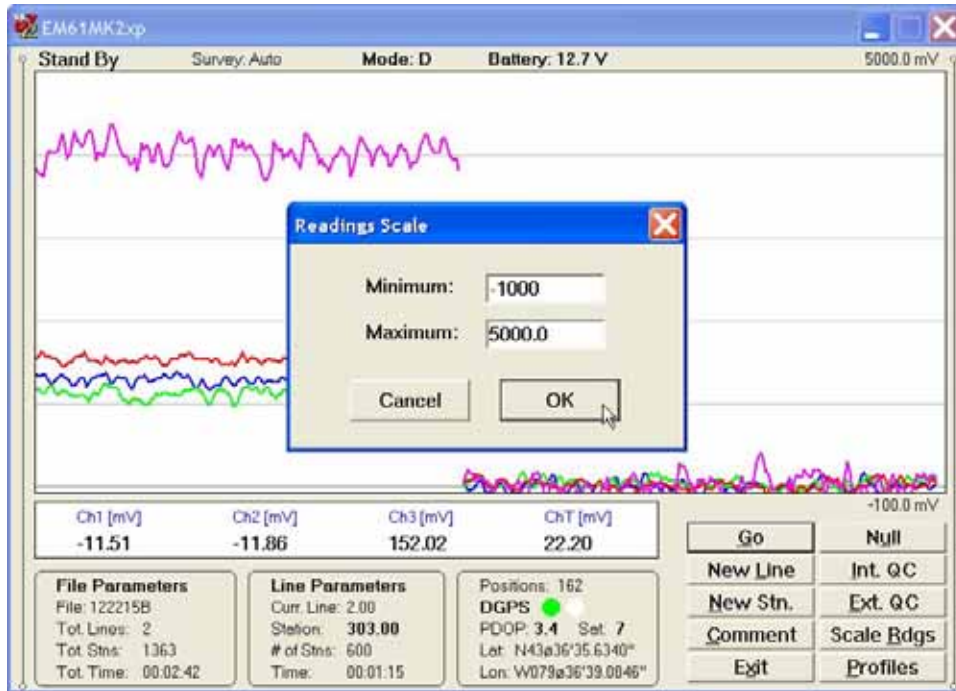

The Enter Scale dialog will be displayed. It contains two text boxes for Minimum and Maximum values of a new scale for profile plot. Current settings (minimum and maximum values) for the scale are displayed in the bottom right and top right corners of the plot area.

After minimum and maximum values are specified click on the button **OK** or press **ENTER** key to accept new values and the profile plot area will be redrawn (see Figure below).

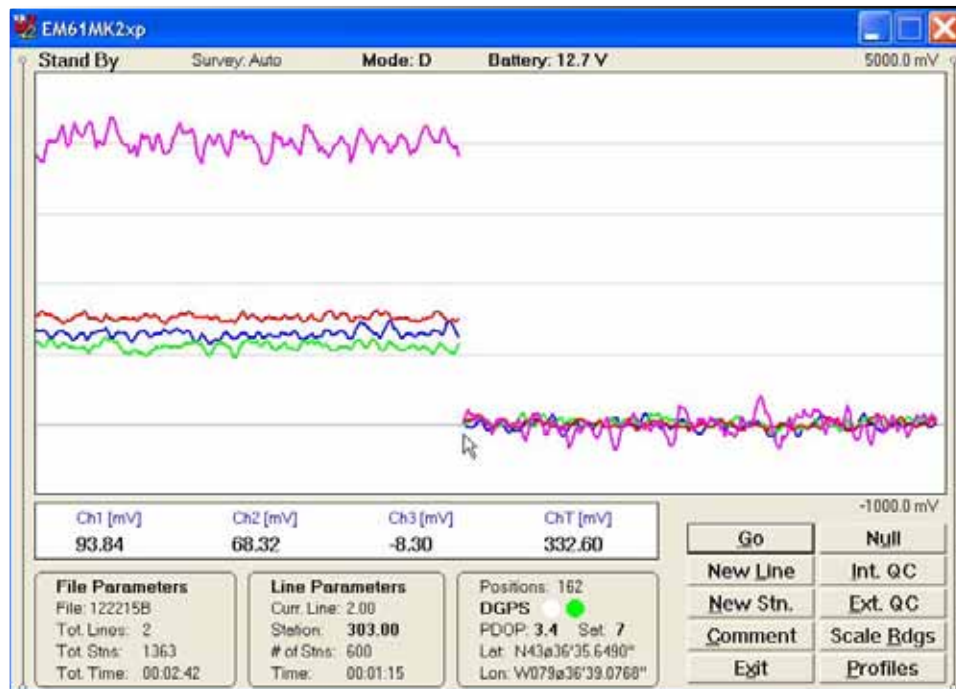

To ignore an entry and return to Stand By mode tap the **Cancel (X)** button or press **Esc** key, the dialog window will disappear and measurements can be continued.

## Profiles *(new options for profile plot display)*

After the **Profiles** button was clicked or executed from the keyboard the Display Options dialog window appears on the screen. This dialog allows you to enable and disable the display of each channel profile, specify color and thickness of profiles, and select linear or compressed amplitude for profiles. The dialog is presented below.

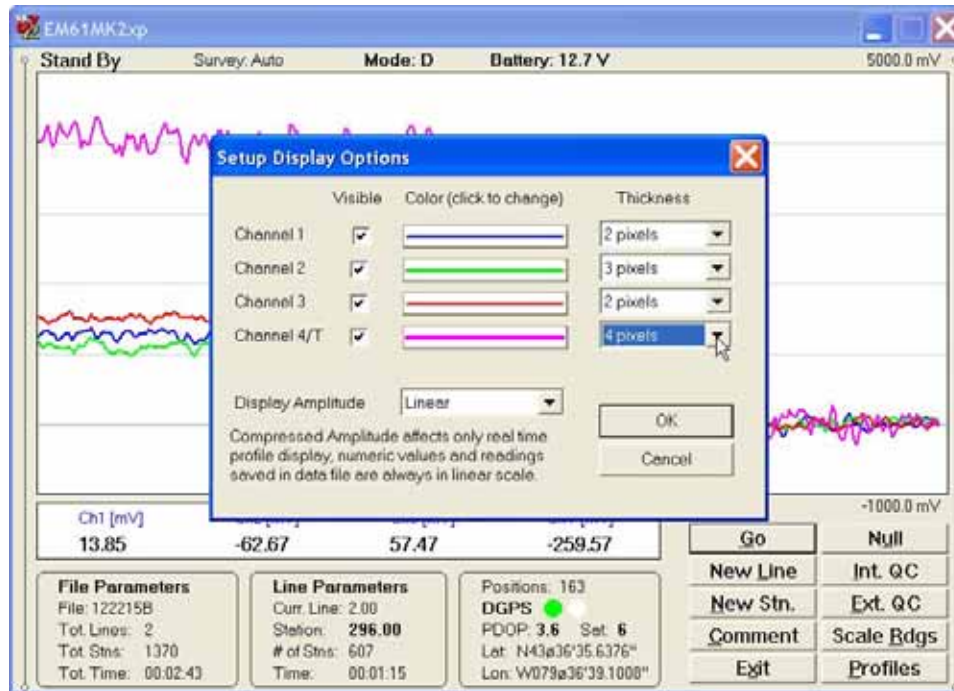

Please refer to chapter 5 where this dialog and its parameters are described in detail.

Click on the button **OK** or press **ENTER** key to accept updated display parameters. The dialog will disappear and profile plot area will be redrawn in Stand By mode.

To return to Stand By mode and current display options (state before this dialog was selected) click on the **Cancel** (X) button or press **Esc** key, the dialog window will disappear.

## Null

During data collection (in Stand By mode) a confirmation message will be displayed (there is no such message if Nulling is performed in Monitoring mode) before actual operation is applied.



After above message is confirmed the program collects 50 readings and calculates the instrument offset.

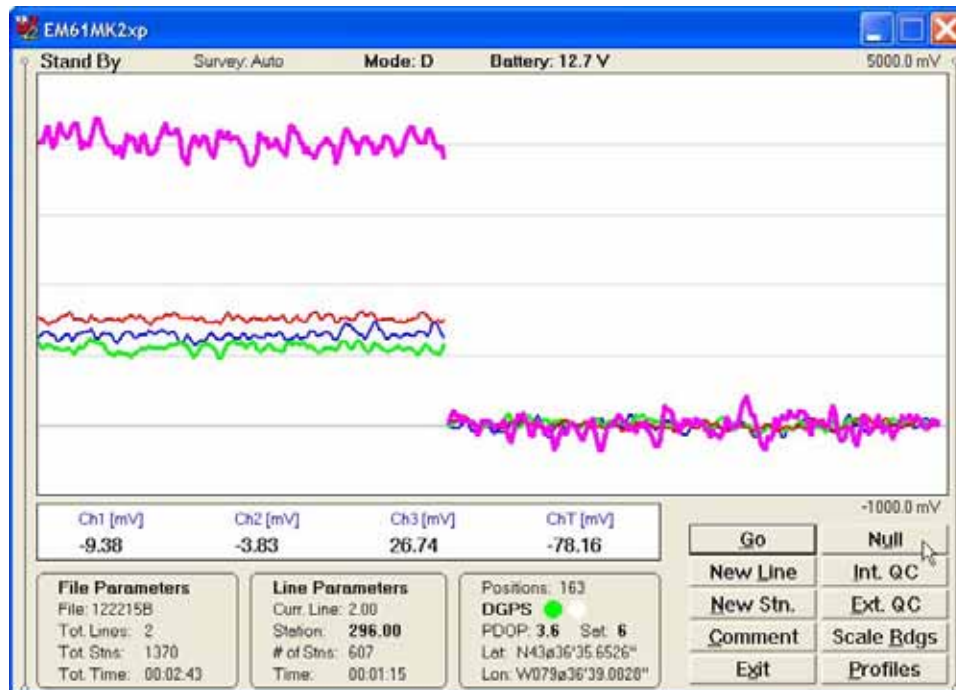

The calculated offset is applied to all the readings that follow this operation. If needed, this procedure can be repeated several times until satisfactory results are obtained. However, there is no associated "Undo" function. If original values (without calculated offsets) of the EM61-MK2 readings are needed, exit the EM61MK2 program and run it again. The EM61-MK2 instrument does not have to be turned OFF.

#### **Int. QC** (*Internal QC coil calibration*)

The Internal QC coil calibration is described in detail in the EM61-MK2 Operating Instructions.

The Internal QC coil procedure in Stand By mode is identical as in Monitoring mode. Please refer to section 6.2 (Description of Monitoring Mode Options) for more screen shots examples.

To start the calibration using Internal QC coil click on the key labeled **Int. QC** or execute this option by keyboard (navigate to the button by pressing **TAB** key and when highlighted press **ENTER** key, or use shortcut - press key **I**). This action begins by performing the automatic nulling which in this case is only in effect for the duration of the calibration process. It will not affect EM61-MK2 readings during later data collection. After the nulling is completed (less than 5 seconds) the Internal QC coil Calibration window is displayed. All command buttons in the bottom right corner of the logging window in Stand By mode are disabled during Calibration procedure.

*When Calibration window is displayed please use keyboard keys (O or C) rather than a mouse to execute buttons labeled OK and Cancel. Clicking on buttons by mouse will work, however several mouse button clicks may be required.*



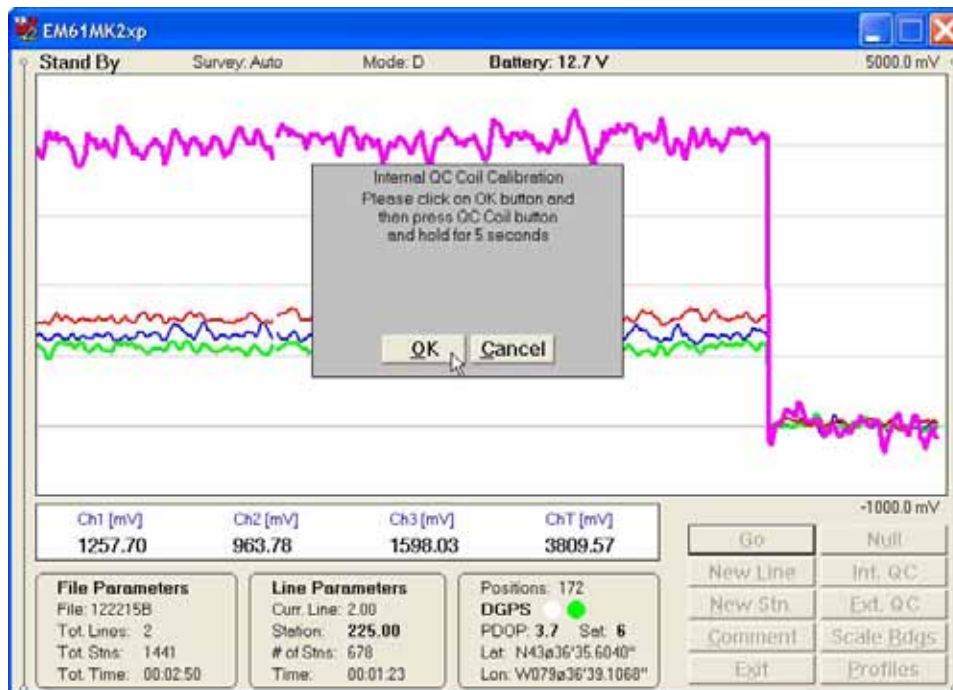

After **OK** button is clicked (or shortcut key **O** is pressed) the window displays timer with elapsed seconds and EM61-MK2 readings. This display lasts for 60 seconds. During this time please follow the instructions provided on the Allegro screen.

Internal QC coil calibration can end in the following four ways:

The process can be stopped by an operator at any time by clicking on the **Cancel** button or pressing shortcut key **C**.

The calibration may end by time out (60 seconds) if QC coil button was not pressed or this action did not activate QC coil.

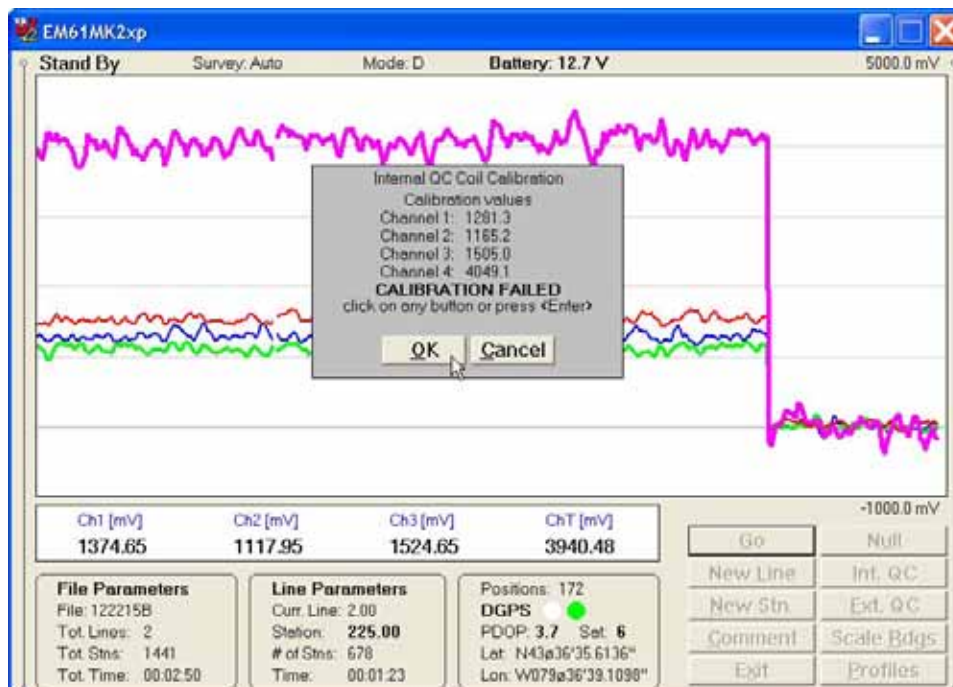

After pressing any key the program returns to Monitoring window. To repeat Internal QC coil calibration please click on the **Int. QC** button again.

The logging program will determine if the instrument has passed test. If after activating the QC coil, the program determines that the reading is inside the standard values within +/- 10% tolerances then a message "CALIBRATION OK" will be displayed.

Otherwise, if the program determines that the reading is outside of the test values range the corresponding message "CALIBRATION FAILED" is displayed (see Figure above).

Regardless of the test result (OK or FAILED) the readings will be saved on screen. The program returns to Monitoring window after any button is tapped or ENTER key is pressed. Then the Internal QC coil calibration process can be repeated.

#### **Ext. QC** (External QC Coil Calibration)

The External QC coil calibration is described in detail in the EM61-MK2 Operating Instructions.

The External QC coil procedure in Stand By mode is identical as in Monitoring mode. Please refer to section 6.2 (Description of Monitoring Mode Options) for more screen shots examples.

To start the calibration using the External QC coil click on the button labeled **Ext. QC** or execute this option by keyboard (navigate to the button by pressing **TAB** key and when highlighted press **ENTER** key, or use shortcut - press key **E**). This action begins by performing the automatic nulling which in this case is only in effect for the duration of the calibration process. It will not affect EM61-MK2 readings. After the nulling is completed (less than 5 seconds) the External QC coil Calibration window is displayed (Figure below).

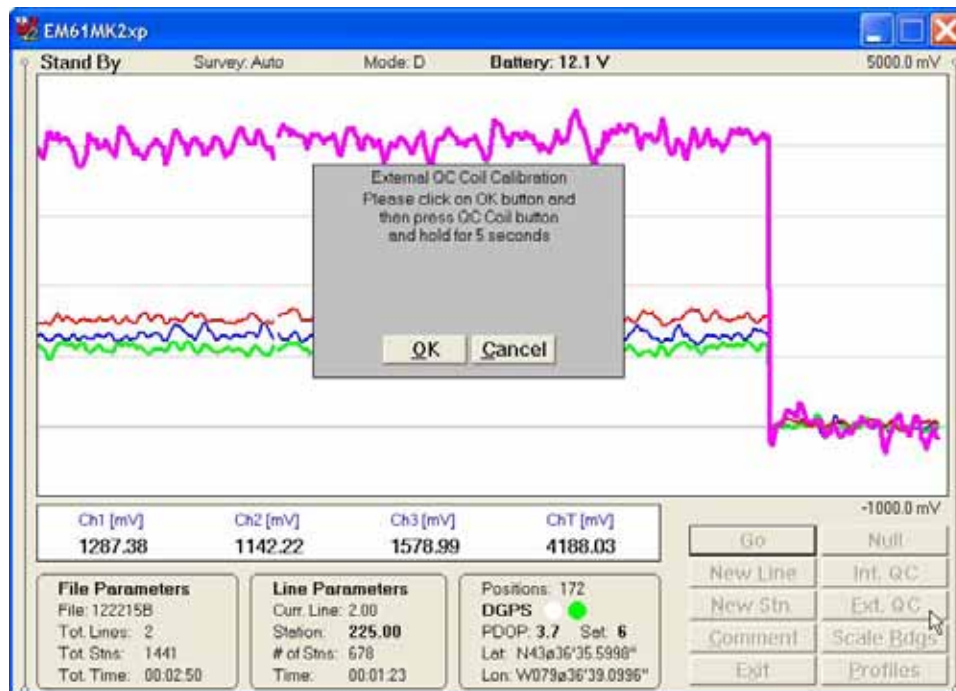

*When External QC Coil Calibration window is displayed please use keyboard keys (O or C) rather than a mouse to execute buttons labeled OK and Cancel. Clicking on buttons by mouse will work, however several mouse button clicks may be required.*

After **OK** button is tapped (or shortcut key **O** is pressed) the window displays timer with elapsed seconds and EM61-MK2 readings. This display lasts for 60 seconds. During this time please follow the instructions provided on the Allegro screen.

External QC coil calibration can end in the following four ways:

The process can be stopped by an operator at any time by tapping **Cancel** button or pressing shortcut key **C**.

The calibration may end by time out (60 seconds) if the External QC coil button was not pressed or this action did not activate QC coil.

After pressing any key the program returns to Monitoring window. To repeat External QC coil calibration please tap the **Ext. QC.** button again.

The logger will determine if the instrument has passed test. If after activating the QC coil, the program determines that the reading is inside the standard values within +/- 10% tolerances then a message "CALIBRATION OK" will be displayed.

Otherwise, if the program determines that the reading is outside of the test values range the corresponding message "CALIBRATION FAILED" is displayed.

Regardless of the test result (OK or FAILED) the readings will be saved on screen. The program returns to Monitoring window after any button is clicked or ENTER key is pressed. Then the External QC coil calibration process can be repeated.

**Exit** (*exit data logging*)

During data collection (in Stand By mode) a confirmation message will be displayed (there is no such message if **Exit** is performed in Monitoring mode) before program exits logging window.

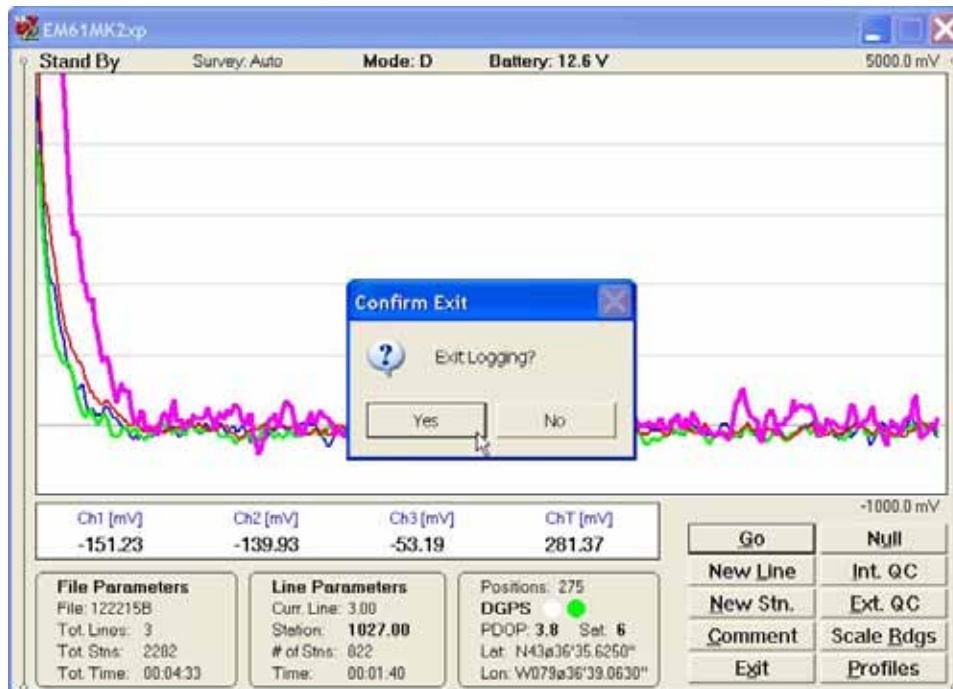

After above message is confirmed the program stops logging, closes data file and returns to Main Screen.

# Appendix A

## A.1 Description of Data File in EM61MK2xp Format

Each record contains 24 characters, including line feed at the end of each record.

**Header of the file (contains six records starting with characters E, H, O, O, O, and O)**

1	2	3	4	5	6	7	8	9	10	11	12	13	14	15	16	17	18	19	20	21	22	23	24
E	M	6	1	M	K	2		W	1	O	1	Survey Type	UT	IT	IM					IP	10		
H																							10
																							10
																							10
																							10

EM61MK2	-	identification of program file
W101	-	version number (1.00, W - indicates file created by Windows CE program)
Survey Type	-	GPS (if GPS Input Enabled) or GRD (grid)
UT	-	unit type (0 = meters, 1 = feet)
IT	-	instrument type (0 =sensor 1x0.5m, 1 = 1x1m, 2 = 0.5x0.5m, 3 = HH61)
IM	-	instrument mode (0 =Auto, 1 =Wheel, and 2 =Manual)
IP	-	not used (=1 fixed)
File Name	-	file name, maximum 8 characters
Time Increment	-	time increment (Auto Mode) in seconds
Offset	-	offset for indicated channels in mV
IC	-	QC coil calibration (=N not performed, <>N otherwise)
QC coil value	-	value of QC coil calibration for indicated channels in mV
10	-	Line Feed character

**Header at the start of survey line (eight records starting with L, B, A, Z, O, O, O, O)**

1	2	3	4	5	6	7	8	9	10	11	12	13	14	15	16	17	18	19	20	21	22	23	24
L																							10
B																							10
A	Dir																						10
Z	D	D	M	M	Y	Y	Y	Y		H	H	:	M	M	:	S	S						10
O																							10
O																							10
O																							10
O																							10

Line Name	-	Line Name, maximum 8 characters
Start Station	-	Start Station for the Line, format F11.2
Dir	-	Direction of the Line (E, W, N, or S)
Station Inc.	-	Station Increment, format F11.3
Date	-	Date when Line was created, format DD-MM-YYYY
Time	-	Real Time when Line was created, format HH:MM:SS
Offset	-	Offset for indicated channels in mV at the start of Line
Former Offset	-	Former offset for indicated channels in mV
10	-	Line Feed character

### Timer Relation

1	2	3	4	5	6	7	8	9	10	11	12	13	14	15	16	17	18	19	20	21	22	23	24
*	Computer Time (Format HH:MM:SS.sss)											Time Stamp in milliseconds										10	

Indicates relation between computer clock and the program timer. This record links timer in milliseconds and computer time (local time) in format HH:MM:SS.sss. This record is written to the file each time a new new line is entered.

### Reading

1	2	3	4	5	6	7	8	9	10	11	12	13	14	15	16	17	18	19	20	21	22	23	24
I	Gn	1h	1l	2h	2l	3h	3l	4h	4l	5h	5l	6	Time Stamp in ms (10 digits)										10

I - indicator T, D, E, F, M, N, P, or Q. Each record representing reading starts with one of the following character, which indicates type of reading:

<b>T</b>	-	Standard, Mode 4,	channels 1, 2, 3, 4
<b>D</b>	-	Standard, Mode D,	channels 1, 2, 3, T
<b>E</b>	-	Hand Held, Mode 4,	channels 1, 2, 3, 4
<b>F</b>	-	Hand Held, Mode D,	channels 1, 2, 3, T
<b>M</b>	-	Standard, Mode 4,	channels 1, 2, 3, 4 +Marker
<b>N</b>	-	Standard, Mode D,	channels 1, 2, 3, T +Marker
<b>P</b>	-	Hand Held, Mode 4,	channels 1, 2, 3, 4 +Marker
<b>Q</b>	-	Hand Held, Mode D,	channels 1, 2, 3, T +Marker

Gn	-	one character parameter (Hex format), contains Gain, see table of ranges at the end of this section.
1h	-	higher byte of the 2's complement Hex number of Channel 1
1l	-	lower byte of Channel 1
2h	-	higher byte of the 2's complement Hex number of Channel 2
2l	-	lower byte of Channel 2
3h	-	higher byte of the 2's complement Hex number of Channel 3
3l	-	lower byte of Channel 3
4h	-	higher byte of the 2's complement Hex number of Channel 4
4l	-	lower byte of Channel 4
5h	-	higher byte of the 2's complement Hex number of TX current
5l	-	lower byte of TX current
6	-	fraction of current (5h 5l), Hex number
Time Stamp	-	time in ms from the Windows start (resets every 49.7 days)
10	-	Line Feed character

**Comment**

1	2	3	4	5	6	7	8	9	10	11	12	13	14	15	16	17	18	19	20	21	22	23	24
<b>C</b>	Comment (maximum 11 characters)												Time Stamp in ms (10 digits)									<b>10</b>	

**New Station**

1	2	3	4	5	6	7	8	9	10	11	12	13	14	15	16	17	18	19	20	21	22	23	24
<b>S</b>	New Station (Format 11.2)												Time Stamp in ms (10 digits)									<b>10</b>	

**Nulling**

1	2	3	4	5	6	7	8	9	10	11	12	13	14	15	16	17	18	19	20	21	22	23	24
<b>O</b>	Offset for Ch1 (F9.2)												Former Offset for Ch1 (F9.2)									<b>10</b>	
<b>O</b>	Offset for Ch2 (F9.2)												Former Offset for Ch2 (F9.2)									<b>10</b>	
<b>O</b>	Offset for Ch3 (F9.2)												Former Offset for Ch3 (F9.2)									<b>10</b>	
<b>O</b>	Offset for Ch4 (F9.2)												Former Offset for Ch4/T (F9.2)									<b>10</b>	

**QC Coil Calibration**

1	2	3	4	5	6	7	8	9	10	11	12	13	14	15	16	17	18	19	20	21	22	23	24
<b>I</b>	<b>C</b>	Offset for Ch1 (F9.2)																					<b>10</b>
<b>I</b>	<b>C</b>	Offset for Ch2 (F9.2)																					<b>10</b>
<b>I</b>	<b>C</b>	Offset for Ch3 (F9.2)																					<b>10</b>
<b>I</b>	<b>C</b>	Offset for Ch4 (F9.2)																					<b>10</b>

IC - **II** indicates Inrenal QC coil calibration,  
**IE** indicates External QC coil calibration.

**GPS Data Message Records**

Each GPS record (GGA Message) is broken in to several 22 characters strings and placed in the EM61MK2 data file which contains 24 characters records, including one character indicator and line feed at the end of each record. The GPS sequence starts at the line which contains character @ as the first character, then records that contain continuation of the same message start with character #. The GPS sequence ends with a line starting with the character !. The last line contains logger time stamp in milliseconds for given GPS reading. A sample of the GPS message written in EM61MK2 format is given below.

1	2	3	4	5	6	7	8	9	10	11	12	13	14	15	16	17	18	19	20	21	22	23	24
<b>@</b>	\$	G	P	G	G	A	,	h	h	m	m	s	s	.	s	s	,	d	d	m	m	.	<b>10</b>
<b>#</b>	m	m	m	m	m	,	s	,	d	d	d	m	m	.	m	m	m	m	m	,	s	,	<b>10</b>
<b>#</b>	n	,	q	q	,	p	p	.	p	,	s	a	a	a	a	a	.	a	a	,	u	,	<b>10</b>
<b>#</b>	±	x	x	x	x	.	x	,	M	,	s	s	s	,	a	a	a	*	c	c	CR	LF	<b>10</b>
<b>!</b>																							<b>10</b>
																							Time Stamp in milliseconds

The GPS sequence may contain 4 to 6 records. Component of the GGA message may differ in length, however they are placed in the same number of columns. Refer to Appendix B (section B.2) for definition of each component of GGA data message.

## A.2 Conversion Factors

EM61MK2 has four channels. Channels 1, 2, and 3 are common for Mode 4 and Mode D. Channel 4 in Mode D is named Channel T (it corresponds to Top coil).

The instrument response is converted to output voltage in mV for each sampling channel as given below.

Channel 1 to 4 - converted data  
DATA1 (to 4) - instrument output for each channel as recorded in logger  
RANGE - range is controlled by the EM61MK2, it can be 1, 10, 100

**Standard Unit - Mode 4** (One Sensor 1 x 0.5 m or 1 x 1 m)

$$\text{Channel 1} = (\text{DATA1} \times 4.8333 \times 2) / \text{RANGE}$$

$$\text{Channel 2} = (\text{DATA2} \times 4.8333 \times 2) / \text{RANGE}$$

$$\text{Channel 3} = (\text{DATA3} \times 4.8333 \times 2) / \text{RANGE}$$

$$\text{Channel 4} = (\text{DATA4} \times 4.8333 \times 2) / \text{RANGE}$$

**Standard Unit - Mode D** (Two Sensors 1 x 0.5 m or 1 x 1 m, Top and Bottom coils)

$$\text{Channel 1} = (\text{DATA1} \times 4.8333 \times 2) / \text{RANGE}$$

$$\text{Channel 2} = (\text{DATA2} \times 4.8333 \times 2) / \text{RANGE}$$

$$\text{Channel 3} = (\text{DATA3} \times 4.8333 \times 2) / \text{RANGE}$$

$$\text{Channel T} = (\text{DATA4} \times 4.8333 \times 4) / \text{RANGE}$$

if coil is 1 x 0.5 m Channel T is further multiplied by a factor 1.114.

**Hand Held Unit - Mode 4** (One Sensor)

$$\text{Channel 1} = 0.902500 \times (\text{DATA1} \times 4.8333) / \text{RANGE}$$

$$\text{Channel 2} = 1.363000 \times (\text{DATA2} \times 4.8333) / \text{RANGE}$$

$$\text{Channel 3} = 2.026795 \times (\text{DATA3} \times 4.8333) / \text{RANGE}$$

$$\text{Channel 4} = 3.018856 \times (\text{DATA4} \times 4.8333) / \text{RANGE}$$

**Hand Held Unit - Mode D** (Two Sensors, Top and Bottom coils)

$$\text{Channel 1} = 0.9025 \times (\text{DATA1} \times 4.8333) / \text{RANGE}$$

$$\text{Channel 2} = 1.3630 \times (\text{DATA2} \times 4.8333) / \text{RANGE}$$

$$\text{Channel 3} = 2.0430 \times (\text{DATA3} \times 4.8333) / \text{RANGE}$$

$$\text{Channel T} = 12.152 \times (\text{DATA4} \times 4.8333) / \text{RANGE}$$

Further each channel is normalized by current following formula:

**Standard Unit**

$$\text{Channel} = \text{Channel} \times 3000 / \text{Current}$$

**Hand Held Unit**

$$\text{Channel} = \text{Channel} \times 1800 / \text{Current}$$

where, current is a value represented by **5h**, **5l**, and **6** in EM61MK2 data file (see section B.1)

Table of Ranges Determined by the EM61-MK2 Microprocessor

HEX	Ch1	Ch2	Ch3	Ch4	HEX	Ch1	Ch2	Ch3	Ch4	HEX	Ch1	Ch2	Ch3	Ch4
0	1	1	1	1	40	10	1	1	1	C0	100	1	1	1
1	1	1	1	10	41	10	1	1	10	C1	100	1	1	10
3	1	1	1	100	43	10	1	1	100	C3	100	1	1	100
4	1	1	10	1	44	10	1	10	1	C4	100	1	10	1
5	1	1	10	10	45	10	1	10	10	C5	100	1	10	10
7	1	1	10	100	47	10	1	10	100	C7	100	1	10	100
C	1	1	100	1	4C	10	1	100	1	CC	100	1	100	1
D	1	1	100	10	4D	10	1	100	10	CD	100	1	100	10
F	1	1	100	100	4F	10	1	100	100	CF	100	1	100	100
10	1	10	1	1	50	10	10	1	1	D0	100	10	1	1
11	1	10	1	10	51	10	10	1	10	D1	100	10	1	10
13	1	10	1	100	53	10	10	1	100	D3	100	10	1	100
14	1	10	10	1	54	10	10	10	1	D4	100	10	10	1
15	1	10	10	10	55	10	10	10	10	D5	100	10	10	10
17	1	10	10	100	57	10	10	10	100	D7	100	10	10	100
1C	1	10	100	1	5C	10	10	100	1	DC	100	10	100	1
1D	1	10	100	10	5D	10	10	100	10	DD	100	10	100	10
1F	1	10	100	100	5F	10	10	100	100	DF	100	10	100	100
30	1	100	1	1	70	10	100	1	1	F0	100	100	1	1
31	1	100	1	10	71	10	100	1	10	F1	100	100	1	10
33	1	100	1	100	73	10	100	1	100	F3	100	100	1	100
34	1	100	10	1	74	10	100	10	1	F4	100	100	10	1
35	1	100	10	10	75	10	100	10	10	F5	100	100	10	10
37	1	100	10	100	77	10	100	10	100	F7	100	100	10	100
3C	1	100	100	1	7C	10	100	100	1	FC	100	100	100	1
3D	1	100	100	10	7D	10	100	100	10	FD	100	100	100	10



### A.3 Example of Data File in EM61MK2xp Format

The Em61MK2 data file records are written in binary format, therefore the file may have different shape when displayed or printed, depending on particular video or printer settings.

```

EM61MK2 W100GPS000 1
H 042320A 0.200
O 0.00E 0.00
O 0.00E 0.00
O 0.00E 0.00
O 0.00E 0.00
LO
B 0.00
AS 1.000
Z23042005 20:02:51
O 0.00 0.00
O 0.00 0.00
O 0.00 0.00
O 0.00 0.00
*20:02:51.000 4179829
@$GPGGA,020412.00,4336.
#59410,N,07936.64856,W,
#2,6,2,141.56,M,-35,M,5
#,119*55
! 4287423
@$GPGSA,A,3,30,,25,,20
#,,14,,06,,01,02.8,02.1
#,02.0*0D
! 4287441
Eÿø \/^ "N 4287673
Eÿ +/" "Q 4287879
C comment text 4287983
Eÿ: G/yi "O 4288089
Eÿ$ h/ib "W 4288279
@$GPGGA,020413.00,4336.
#59408,N,07936.64857,W,
#2,6,2,141.51,M,-35,M,6
#,119*58
! 4288338
Eÿ¶ 5/ # "S 4288488
@$GPGSA,A,3,30,,25,,20
#,,14,,06,,01,02.8,02.1
#,02.0*0D
! 4288419
Eÿb °/j "O 4288677
EÿL t/k "Q 4288885
@$GPGGA,020414.00,4336.
#59411,N,07936.64846,W,
#2,6,2,141.68,M,-35,M,6
#,119*5D
! 4289337
Eÿ4 (/± . 4290288
@$GPGGA,020415.00,4336.
#59411,N,07936.64845,W,
#2,6,2,141.69,M,-35,M,7
#,119*5F
! 4290338
EÿÈ 1/Y . 4290496
@$GPGSA,A,3,30,,25,,20
#,,14,,06,,01,02.8,02.1
#,02.0*0D
! 4290417
Eÿtr /F 4290687
Eÿkø/ à :
4290893
Eÿh/lA :
4291101
Eÿ2 Å/5Ñ . 4291293
@$GPGGA,020416.00,4336.
#59420,N,07936.64848,W,
#2,6,2,142.11,M,-35,M,4
#,119*5C
! 4291335
E
tsY3 . 4291502
@$GPGSA,A,3,30,,25,,20
#,,14,,06,,01,02.8,02.1
#,02.0*0D
! 4291414
Eÿ* bE "Y 4291691
C building 4291793
E
# *â "V 4291900
E_/D "C 4292299

```

---

# Appendix B

## B.1 Using the EM61MK2xp with a GPS Receiver

The EM61MK2xp program accepts input from GPS receiver that stream NMEA-0183 compatible data through their output port. The program uses two NMEA messages: GGA and GSA. The entire GGA message is used later by the DAT61MK2 program, while the GSA message is used only to display PDOP index on the logger screen.

The GPS system means (control device, receiver panel, or manufacturer software) must be used to set GPS receiver communication parameters, to specify frequency of GPS output, and number and type of NMEA messages sent by the GPS system output port. Any GPS system can send various NMEA messages. **It is important to select only two messages (GGA and GSA) that are actually used by EM61MK2.** The program will accept any GPS string sent by the GPS receiver, however it uses time to process GPS data that is not being used. Therefore, selecting a larger number of NMEA messages for GPS output will result in slower data acquisition of EM61MK2xp. Normally, the EM61MK2xp running in a Windows XP based computer uses less than 100 ms to process and record GPS data from two NMEA messages, GGA and GSA.

Only message GGA is necessary to position EM61-MK2 data. If message GSA is not available in a particular system, the EM61MK2xp will function and record position data based on GGA message. Lack of GSA message will result in PDOP index displayed as Not Available (N/A) on the logger display. Using message GGA alone will also result in slightly faster operation of the program. The speed can be further improved by setting higher Baud Rate (if it is supported by the employed GPS receiver) in Set GPS Port menu.

The EM61MK2xp dedicates portion of the display and shows GPS status in a frame box. A number following the label **Position** provides the number of GPS positions saved in the current data file. Next two lines in this frame display parameters describing quality of GPS positions. A label **DGPS** (Differential Global Positioning System) indicates that GPS readings are differentially corrected in real time, while label **AGPS** (Autonomous Global Positioning System) indicates lack of differential correction. On the right side of **DGPS** or **AGPS** label two green and white circles alternate. These two circles should alternate colours with the frequency of GPS update rate (usually 1 second intervals). If the circles do not change colours for long periods of time it means that the GPS system is not working or that it is not connected to the field computer.

The next label **PDOP** with a value varying between 0 and 99.9 represents an index called Position Dilution of Precision (**PDOP**). This value is available only when messages both, GGA and GSA are received from GPS. This index measures the strength of satellite coverage for a given area. PDOP is affected by the number of satellites visible and their relative positions in the sky. The smaller the number of PDOP the stronger the satellite coverage is. When there are more than 5 satellites widely spaced visible, the PDOP is 4 or less. However, when there are less satellites visible, or they are unevenly spaced in the sky, PDOP values can be 6 or higher. In most cases, the PDOP in an open sky is less than 3, and most accuracies given for many GPS systems are given for this norm. Refer to GPS documentation and literature for more information related to error sources of GPS positioning.

The last label **Sat** and following number shows number of currently tracked satellites.

Two bottom lines of the frame give current Latitude and Longitude of the instrument position (datum WGS1984). Position is updated with frequency of GPS receiver stream.

## B.2 Description of GGA and GSA Data Messages

### GGA Data Message

The GGA message contains the GPS position information and it is the most widely used NMEA data message. This message takes the following form:

```
$GPGGA,hhmmss.ss,ddmm.mmmmm,s,dddmm.mmmmm,s,n,qq,pp.p,saaaa.aa,u,  
±xxxx.x,M,sss,aaaa*cc<CR><LF>
```

Definition of GGA message component:

hhmmss.ss	UTC time in hours, minutes, seconds of the GPS position
ddmm.mmmmm	Latitude in degrees, minutes, and decimal minutes
s	s=N or s=S, for North and South latitude
dddmm.mmmmm	Longitude in degrees, minutes, and decimal minutes
s	s=E or s=W, for East and West longitude
n	Quality indicator, 0 = no position, 1 = raw, no differentially corrected position, 2 = differentially corrected position, 9 = position computed using almanac information
qq	Number of satellites used in position computation
pp.p	HDOP = 0.0 to 99.9
saaaa.aa	Antenna altitude
u	Altitude units, M=meters
±xxxx.x	Geoidal separation (requires geoidal height option)
M	Geoidal separation units, M = meters
sss	Age of differential corrections in seconds
aaaa	Base station identification
*cc	Checksum
<CR><LF>	Carriage return and Line feed

### GSA Data Message

The GSA message contains active satellites and PDOP value. The GSA message is given in the following form:

```
$GPGSA,c1,d1,d2,d3,d4,d5,d6,d7,d8,d9,d10,d11,d12,d13,f1,f2,f3*cc<CR><LF>
```

Definition of GSA message components:

c1	Mode, M = manual, A = automatic
d1	Mode, 2 = 2D, 3 = 3D
d2-d13	Satellites used in position computation (range 0 to 32)
f1	PDOP (range 0 to 99.9)
f2	HDOP (range 0 to 99.9)
f3	VDOP (range 0 to 99.9)
*cc	Checksum
<CR><LF>	Carriage return and Line Feed

**C. SURVEY PROCEDURE**

## C. SURVEY PROCEDURE

### 1. Survey Layout

A few minutes spent on the survey planning can save many hours during the preparation of data for mapping and interpretation. The survey reference point and reference line should be selected according to the site geometry and anticipated map layout. The survey lines should be parallel with either horizontal (**x**) axis or vertically (**y**) axis, regardless of the compass direction of the site.

If the direction of the expected target is known, chose the one (**x** or **y**) that is closer to being perpendicular to the targets longer dimension. For example, if you are looking for buried pipes, survey lines should be perpendicular to the pipe.

An exception to the above is when an expected target is parallel and close to a building, fence or wall. In such a case, lines should be parallel to the building (wall, fence) in order to produce a more continuous line across the anomaly. Otherwise, if the lines direction is perpendicular to the building a small error in the start and end of lines, that happen to be near the anomaly, will distort the pictures of the target.

In the case that target position or shape is not known, the most optimum line direction is the one parallel with the site's longest dimension. Once the line direction is selected, the labelling of lines should be done carefully. During the field operation direction, choice of negative and positive increments and start stations for each line should be entered according to the chosen geometry. Since the polycorder program records data only in one dimension (along the profile line) it is very helpful, and should be standard procedure, to use co-ordinates value in the line name. If for example, line co-ordinate is 10 (**x** or **y**), the line name should be labelled 10, or in the other example if the line adjacent to the zero line is separated 1 meter from it, this line should be labelled as 1.

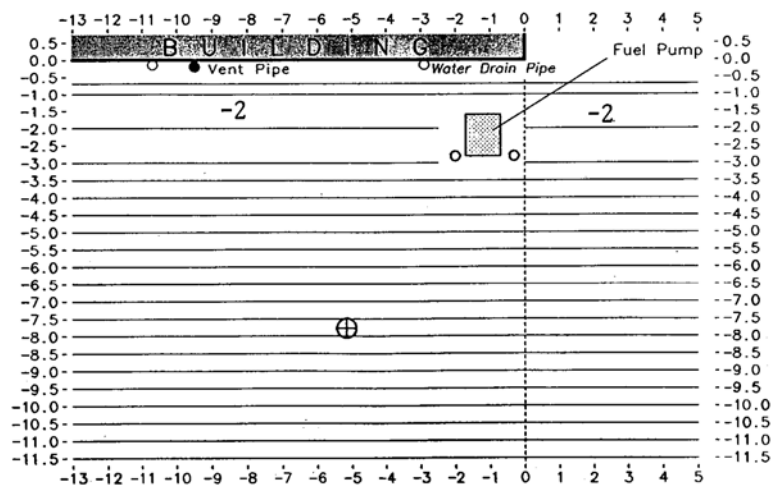

The reference line (zero line) should go through reference point (0,0). If the lines are parallel with **x** axis, lines above the reference line are labelled as positive and lines below the reference line should be labelled as negative. If the lines are vertical (parallel with the **y** axis), lines to the right of the reference line are labelled positive and those to the left negative.

If the line is broken in several parts, different segments of this line should be labelled with the same name but a different start station.

## 2. Survey Line Spacing

The EM61 is an extremely high lateral resolution metal detector, and in comparison with some other metal detectors, especially with magnetometers, is more suitable for work in dense industrial environment, in the vicinity of buildings, fences, power lines and other sources of interferences. This advantage however leads to requirement of relatively fine spacing between the survey lines. It is a known fact that the higher number of data per unit area leads to easier and more accurate interpretation of data. This is especially true in case of environmental geophysics, dealing often with a large amount of anomalies distributed within relatively small site. The optimal separation between survey lines is 1 m (or 3 feet) and should not exceed 2 m (or 6 feet). In the case when 2 m spacing is used, large buried metallic targets will be detected, but the smaller near surface targets could be missed. In this case it is recommended that the operator monitors collected readings and in more complicated areas additional lines are added. For small sites with very high target density 0.5 m line spacing is sometimes used.

## 3. Survey Station Spacing (Recording Interval)

As pointed out earlier, EM61 is an extremely high lateral resolution instrument, meaning that it has capabilities to resolve closely spaced anomalies. To take full advantage of its resolution power, it is recommended that the station (recording) interval is in the range of 0.2 m (8"). Note that if the odometer mounted on the trailer wheel is used for recording, the interval is fixed at 0.193 meters or 0.63 feet.

## 4. Control of Recording and Instrument Position

The control of recording and instrument position along the survey line can be achieved by three different methods: odometer mode, auto mode and manual mode. Description of each mode follows:

### 4.1 Odometer Mode

Recording intervals and, therefore, recorded instrument position on the survey line is controlled by odometer/counter mounted on the trailer wheel. Triggering interval (increment) is fixed (it cannot be changed by operator) and it is nominally 0.193 meters or 0.63 feet. Two main factors can affect accuracy of increments: condition of the wheel tires (air pressure in the tire) and condition of test area surface. The larger effect of two is normally as a result of surface condition like: stones, tall grass, concrete curbs, etc.

The operator can easily determine increments for most conditions by surveying a test line of known length (approximately same length as survey lines) and then enter more accurate increments in the polycorder program.

In most cases however, the length of the survey line is known and the value for the increment of the wheel counter can be adjusted later during the processing of the data. For this reason it is always useful to record (e.g. in the field book) the end station of each survey line. If the test for the wheel counter is not performed in the field, the optimum value that should be entered in the logger is 0.193 meters (or 0.63 feet). It is recommended that while surveying longer lines a fiducial marker is used at the known intervals approximately 20 m (or 50 feet) apart. Stations with recorded markers can be easily positioned using program DAT61. This procedure will greatly improve accuracy of the survey.

#### 4.2 Auto Mode

The auto mode of recording is normally performed if the trailer mode is either not available or not practical to use. In this mode data is collected at the time interval specified by the operator. The accuracy of the instrument positioning will depend mainly on the ability of the operator to walk at the constant speed. It should be noted that the speed of surveying should not exceed 1 m/s (or 3 feet/s). Since the recommended station interval is about 0.2 meters and with typical speed of 0.6 to 0.4 m/s, the recording rate in auto mode should be set to 2 to 3 records per second. The use of the fiducial marker is highly recommended if the auto mode recording is used. The marker should be used at the controlled intervals 5 to 10 meters (15 to 30 feet) apart.

#### 4.3 Manual Mode

Manual mode of operation is used in the case, similar to auto mode, when the wheel mode of operation is either not available or, due to the difficult terrain, not practical to use. This mode is more labour intensive and slower but more accurate than the auto mode. In this mode of recording operator marks the survey lines, most conveniently by laying measuring tape on the ground along the survey line, and records data by pushing recording button at the appropriate stations. As in the auto mode, recommended station intervals should be between 0.2 to 0.3 meters (8" to 12").

### **D. DATA PRESENTATION**

The EM61 data is characterized by very high spatial resolution, high anomaly gradients (large change of response in the short spatial interval) and very high dynamic range of readings (response can range from 0.2 mV to 13 000 mV). As a consequence processing and presentation of EM61 data requires special consideration in order to obtain full advantage of the technique.

There are two types of basic presentation of EM61 data; profile form and contour maps. The following is a list and some examples of EM61 data with the several types of common mode of presentation.

## 1. Data Presented in Profile Form

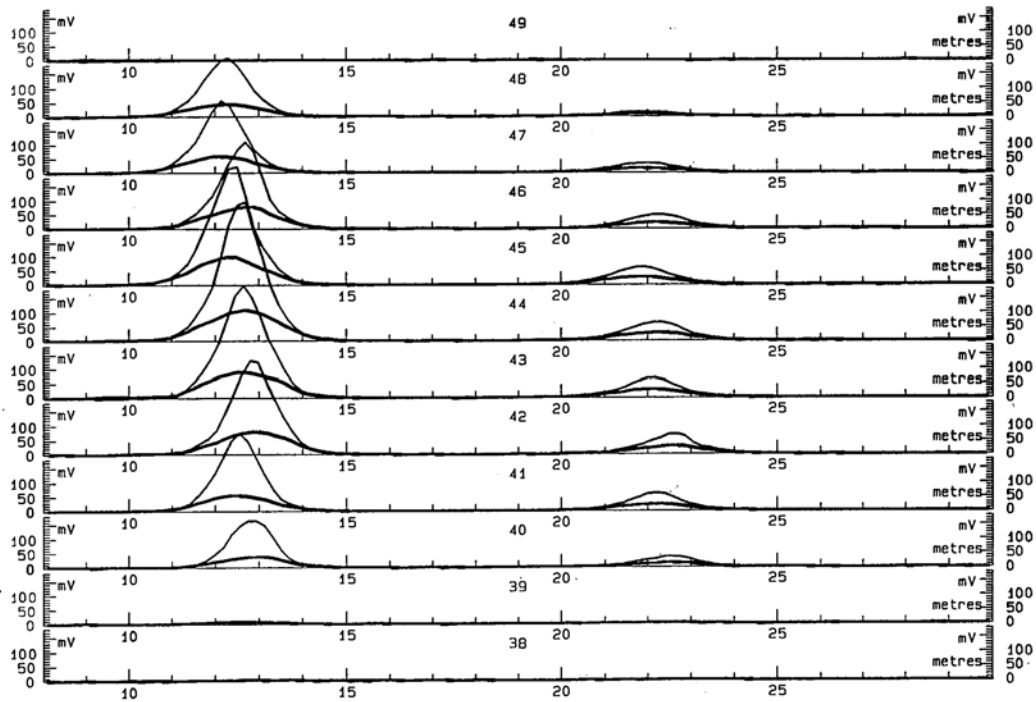

Figure 4

### 1.1 Comments Regarding the Presentation of Data in Profile Form

When looking for deeper targets that produce small amplitude (several tens of mV), the most optimum scale is the one that produces visible noise level, (typically 2 - 3mV for channel T and 1mV for channel 3). Due to the very large dynamic range of EM61 response, it is sometimes necessary to plot data at two different scales: first based on the maximum amplitude, and second based on the resolution and data noise level, and letting higher amplitude response to saturate.

## 2. Data Presentation in the Contouring Form

### 2.1 Samples of Black and White Contour Maps (Figure 5)

- a. Line contour map
- b. Gray filled line contour map
- c. Shaded relief contour map



- 2.2 Samples of Colour Contour Maps (Figure 6)
- a. Colour filled contour map
  - b. Colour filled contours with shaded relief map
  - c. Colour shaded relief map

EM61 RESPONSE  
CHANNEL 3  
LINE CONTOUR MAP

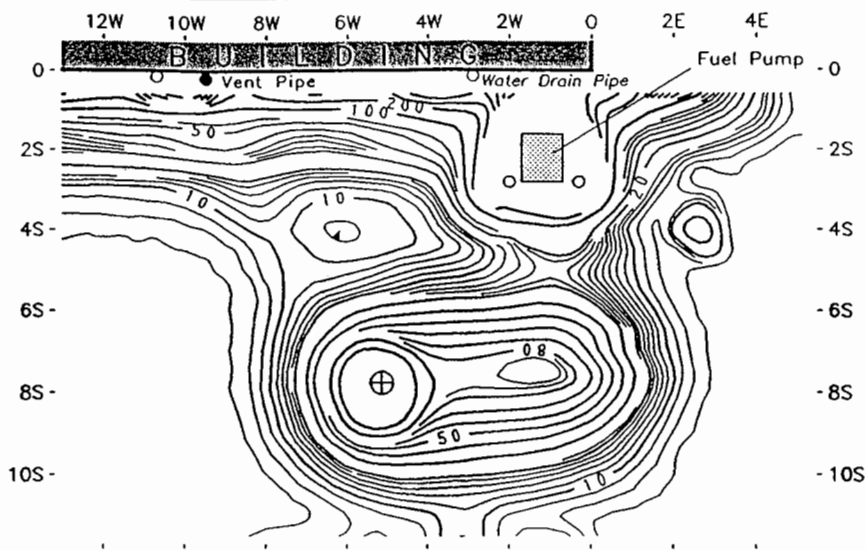

EM61 RESPONSE  
CHANNEL 3  
GREY FILLED CONTOUR MAP

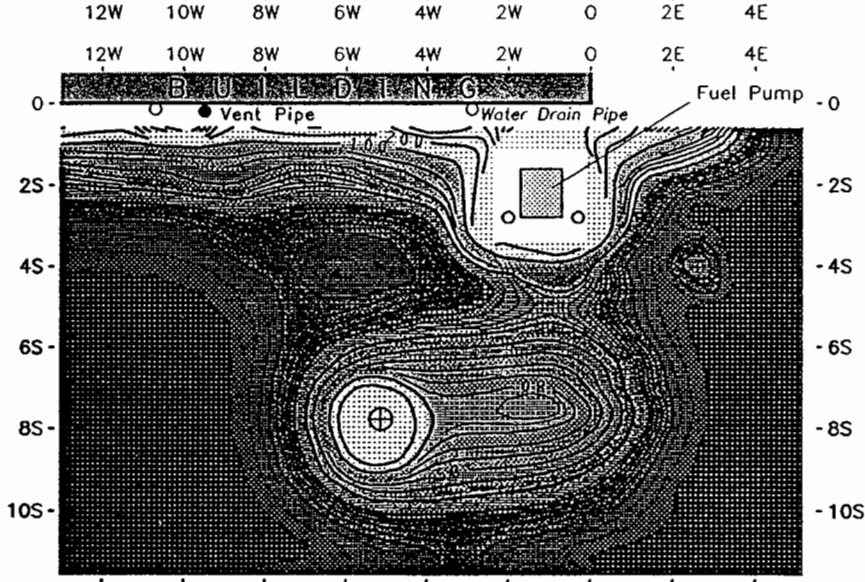

EM61 RESPONSE  
CHANNEL 3  
SHADED RELIEF MAP

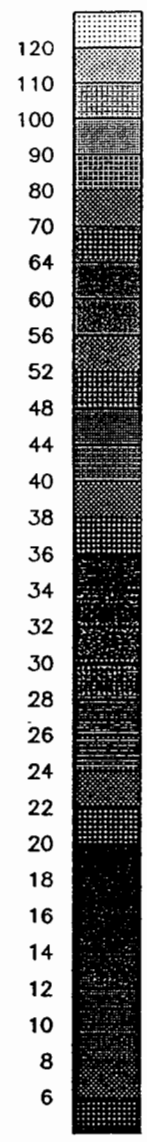
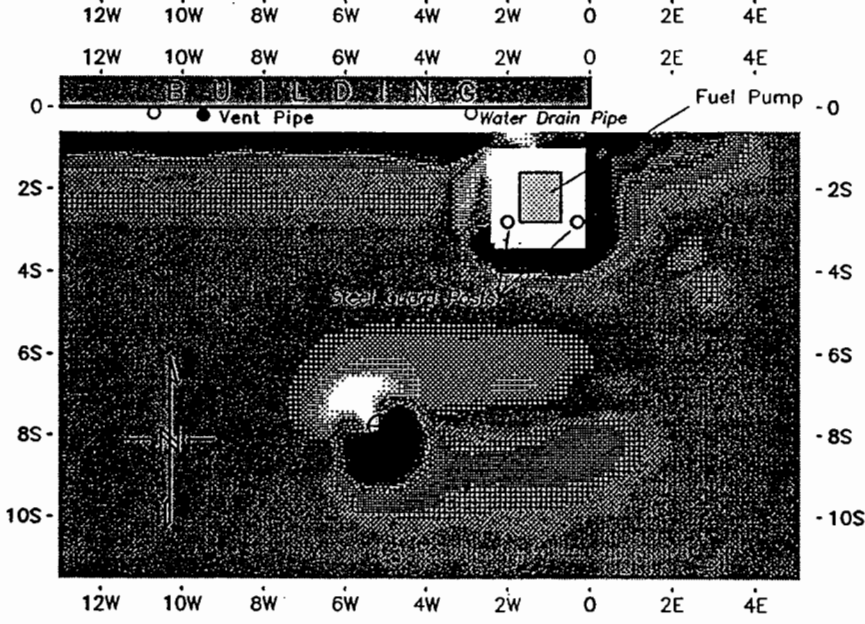

Response [mV]

⊕ - Small Manhole  
Horizontal Scale in Metres

GEONICS EM61 SURVEY OF A SITE WITH AN UNDERGROUND STORAGE TANK

Geomar Geophysics Ltd.

Figure 5  
6

EM61 - CHANNEL 3  
COLOUR FILLED  
CONTOUR MAP

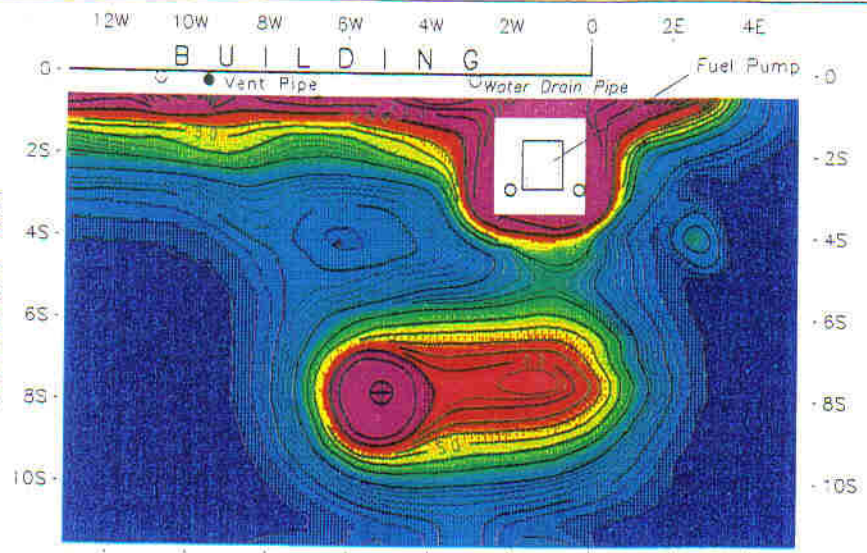

EM61 - CHANNEL 3  
COLOUR CONTOUR MAP WITH  
OVERLAIN GREY SHADED RELIEF

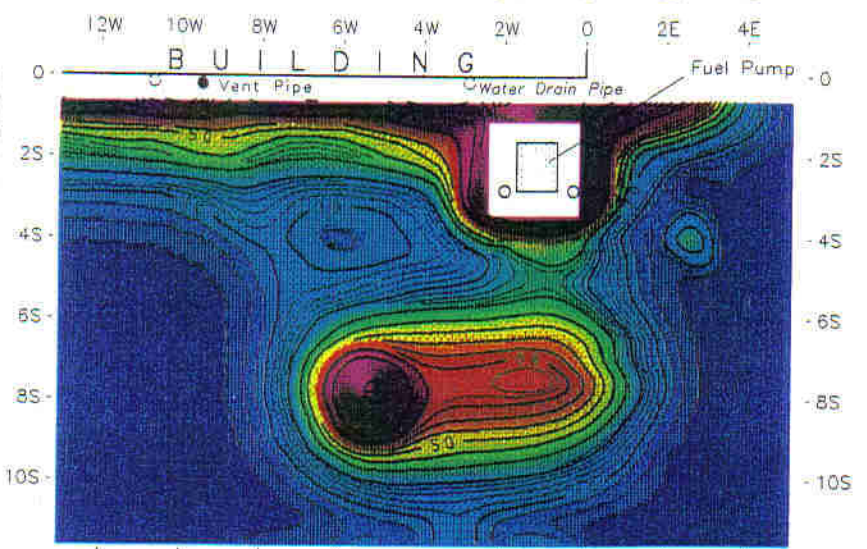

EM61 - CHANNEL 3  
COLOUR SHADED  
RELIEF MAP

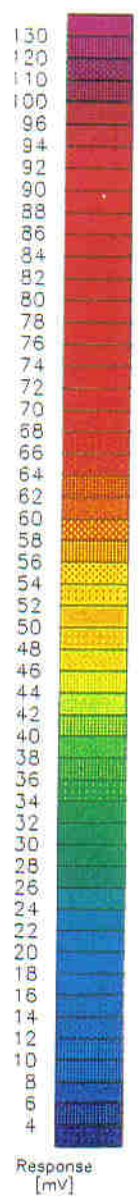
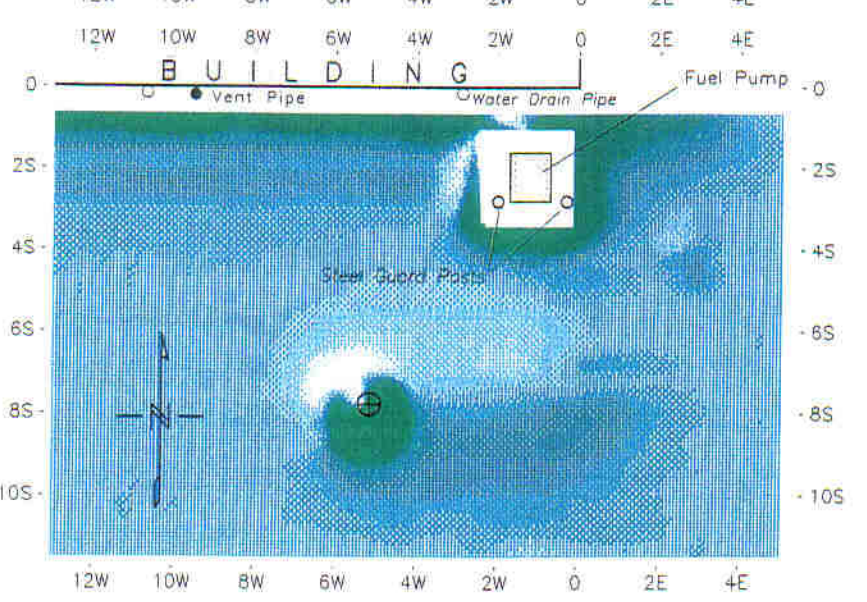

⊕ - Small Manhole  
Horizontal Scale  
in Metres

### GEONICS EM61 SURVEY OF A SITE WITH AN UNDERGROUND STORAGE TANK

Geomar Geophysics Ltd.

Figure 6

## 2.3 Comments Regarding the Presentation of Data in Contouring Form

As mentioned earlier, the typical separation between data points during the recording is 0.19 m (0.62') along the survey line, and 1 m (3') across the lines. The adequate grid cell size for contouring would be 0.2 to 0.25 m (0.65 to 0.8 feet). A contouring software usually has a specified maximum number of grid points that can be used for contouring (GEOSOFT Mapping Software has 120,000 grid points for the **Geonics** package). One should also calculate what is the maximum size of the survey area that can be plotted on one map. In most cases presenting more than 1 hectare (or 2 acres) on one sheet (up to B size) leads to some loss of information, unless software allowing large number of gridding points and larger sheet size is used.

During gridding procedure care should be taken which interpolation algorithm is used. Since the typical EM61 anomaly has relatively high gradient, the commonly used cubic interpolation very often produces overshoots that generates visible ghost depressions on the map. This effect can be alleviated by using Akima spline available in GEOSOFT Mapping Software. Spline should be used along and across the direction of survey lines.

During selection of colour scale for map of the EM61 data, the default settings of contouring software uses extreme values from data set. One should note that in most cases important anomalies, originated by deeply buried objects, are of much lower amplitude (tens or hundreds of mV) than those originated by near surface targets (thousands of mV). Adjusting the colour scale to the lower portion of the data range and leaving saturated high amplitude anomalies (usually short spatially) will produce reasonable map.

## E. DATA INTERPRETATION (Applies to D (Differential) mode only)

The EM61 is designed in such a way that it is possible not only to separate anomaly spatially, but it is also possible under most conditions, to distinguish deeper targets from shallow ones. In addition, the unique two receiver coil system allows suppression of near surface targets that may mask response from deeper more important ones. This feature is very useful when the purpose of the survey is to locate deeper targets, like underground storage tanks or drums, in presence of shallow near surface metallic objects (manhole cover or metal scrap).

Further benefit of two receiver coils is the ability of the system to reduce the effect of external noise as it will be described later.

### 1. Separation of Shallow and Deeper Targets (Suppression of Near Surface Targets Response)

The two receiver coils antenna system used in EM61 is very helpful in recognition of near surface object from deeper targets.

Since the amplitude of response is highly depended on the distance between the coil assembly and target, small near surface anomalies will very often produce a response orders of magnitude larger than much bigger but deeper targets. This

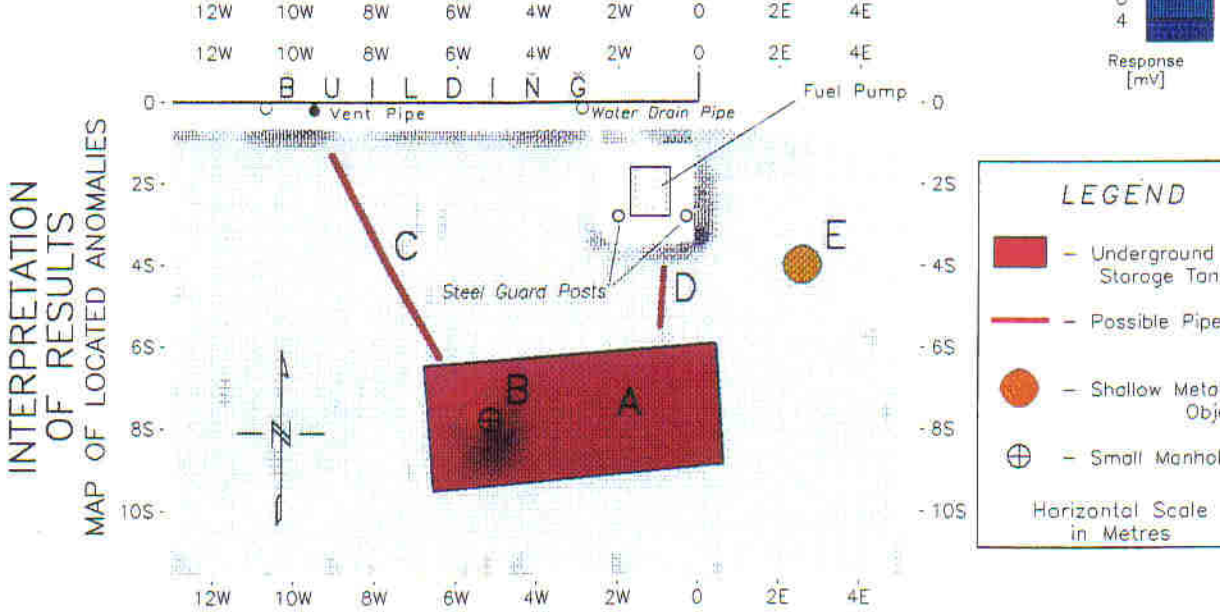
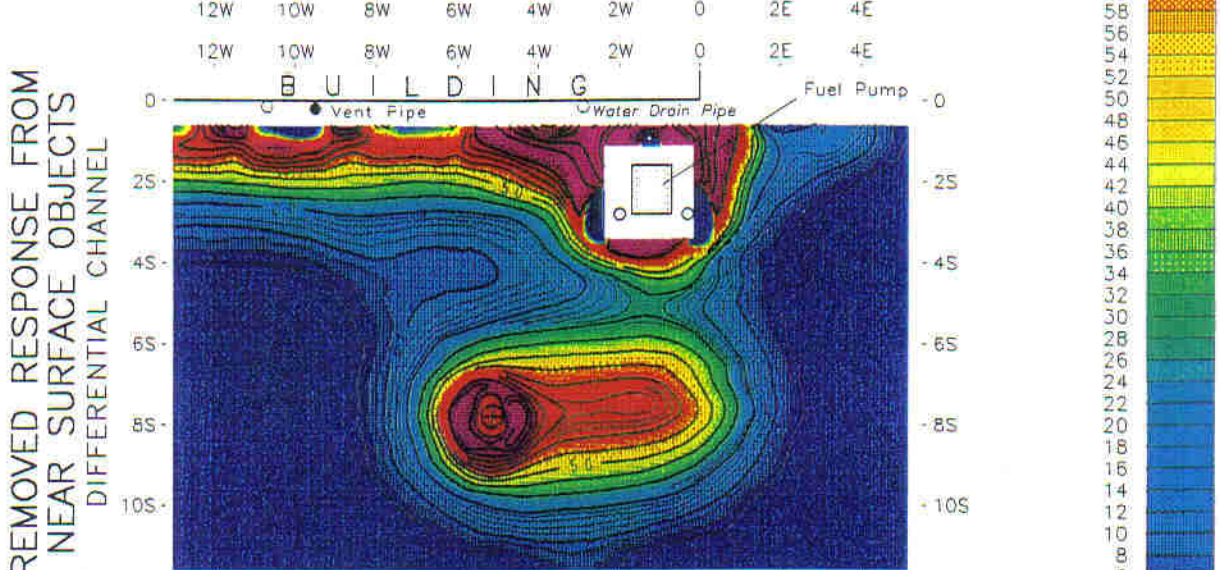
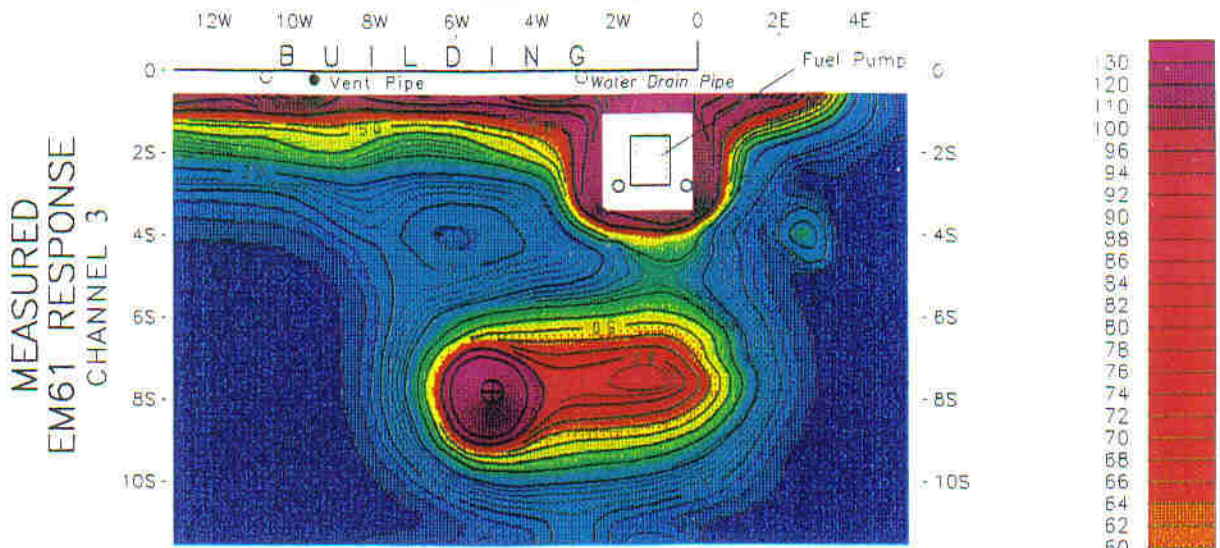

GEONICS EM61 SURVEY OF A SITE WITH AN UNDERGROUND STORAGE TANK

Geomar Geophysics Ltd.

Figure 7

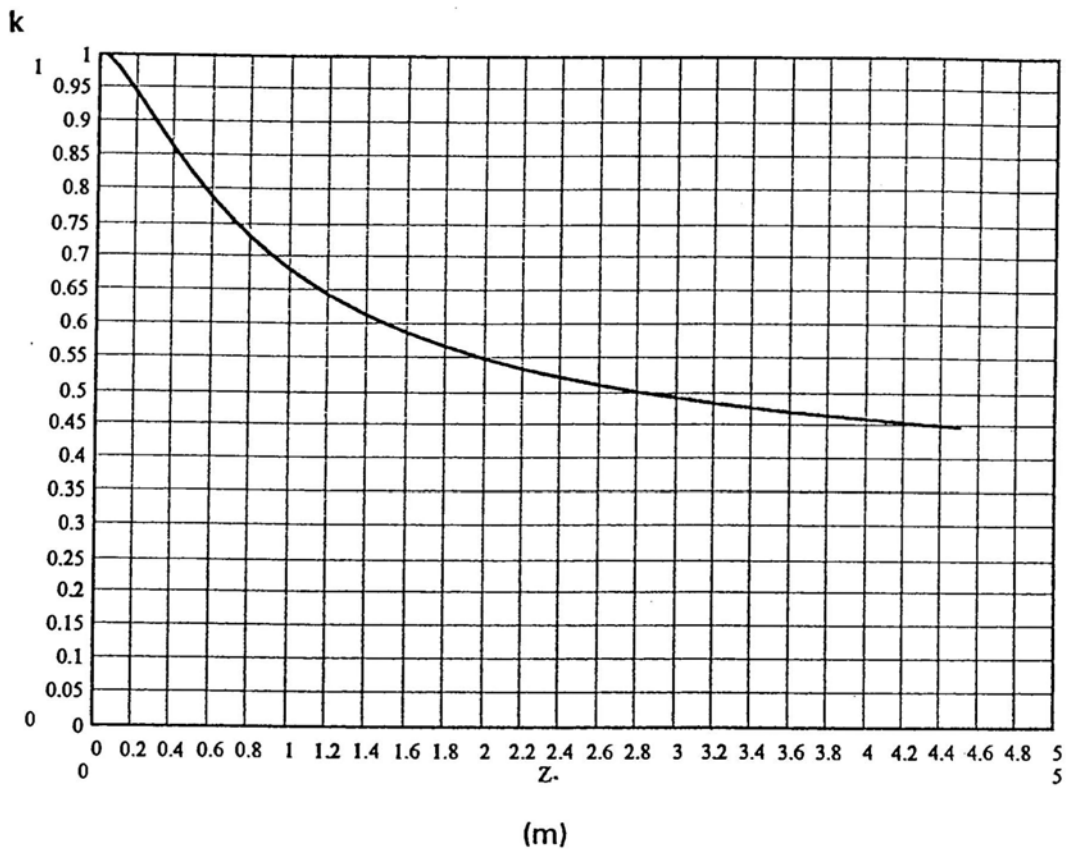

Figure 8

masking effect from near surface material could be drastically reduced by using output of two coils and process them in the differential mode. In this case output from channel 3 is subtracted from channel T. Channel T represents data from top receiver coil, whereas channel 3 is data from coil closer to the ground. This calculation is automatically performed by EM61 DAT61 computer program.

The most common way of interpretation of EM61 data is by using channel 3 and differential channel data.

The differential channel is calculated by the program in the following way:

$$D = k \text{ CHT} - \text{CH3}$$

where:                      D is differential output in mV  
                                  CHT is output from top coil in mV  
                                  CH3 is output from bottom coil in mV - Channel 3  
                                  k is depth coefficient normally set to 1

It is possible to vary **k**, and adjust the depth at which the response will be suppressed the most. If **k** is selected to be 1, the response from targets right below the surface will be reduced the most. If the coefficient **k** is made smaller than 1, the deeper target will be suppressed more than shallow targets. In this case surface anomalies will have negative response in the differential channel.

It should be noted that the degree of cancellation will be affected by size, shape and depth of targets. The response from the targets with the small dimensions shaped like balls, shales or small plate-like targets parallel with the ground, is possible to reduce much more than response from larger 3 dimensional targets.

Figure 7 is an example of data presentation and interpretation using channel 3 and differential channel data. Channel 3 map (Figure 7a) contains information about all targets within the reach of EM61 system. This includes near surface and deeper targets response. On the other hand the differential channel map (Figure 7b) shows mostly deeper targets with removed or largely suppressed response from near surface material. For example, anomaly "E" on the right top corner of Figure 7a has disappeared on Figure 7b indicating a shallow target.

The Figure 7c shows interpretation based on channel 3 and differential channel data.

Locations of pipes C and D are based on the information from the profile plots, as well as from the "saddle" type of response on the channel 3 contour map.

Note that the negative values on the differential channel map are often associated with the metallic objects located above the surface, assuming that the depth coefficient of 1 is used (normal practice).

## 2. Calculation of Apparent Depth of Target

The EM61 computer program DAT61, version 1.3 or later, allows the user to estimate an approximate depth (apparent depth) of a target. This parameter is calculated on the basis of ratio of amplitude from channel T and channel 3 response. The apparent depth estimation is most accurate when the instrument is positioned over the center of buried target. (An additional reason from choosing fine spacing between the survey lines). In order to determine position of an anomaly, the peak response of the channel 3 profile should be examined along the survey line, as well as, on the neighbouring survey lines. By comparing responses of nearby lines and selecting anomaly maximum, it is normally easy to locate the position of the target. The apparent depth is determined at the highest point (peak) of the anomaly.

It should be noted that the calculation of depth is an approximation. The accuracy of estimation will depend on the relation between the line (station) and center of the target, the size and shape of target, as well as on the quality of data.

Depth estimation for the smaller ball shaped targets will be more accurate than the estimation for larger targets (like underground storage tanks or pipes). Depth for the larger targets will be normally overestimated, meaning that the anomaly will appear deeper than it actually is.

In order to improve depth estimation accuracy, especially for deeper targets with low response, it may be necessary to remove a small offset from the readings. Although each instrument prior to leaving the factory has outputs of both channels adjusted to read zero, it is possible that with time a small offset of several millivolts appears at the output(s). This effect could be recognized as a small non-zero shift in readings over the portion of the survey line that has no visible anomaly response. EM61 computer program DAT61 allows removal of such offset by shifting the whole line by a constant.

Figure 8 is an example of EM61 data from the site with buried ordnances. Line 531 is the line closest to the center of the targets (amplitude of response on this line is larger than response from adjacent lines 3 feet apart on each side). Vertical lines and associated numbers indicate selected targets and calculated depth in feet below the surface.

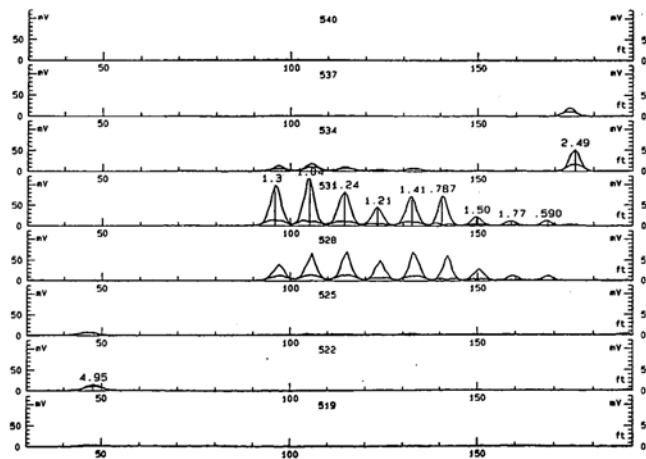

Figure 8



3. Reduction of External Noise  
(Channel N)

The EM61 is designed to reject the influence of the external noise to a very high degree. Nevertheless, in some special cases where the sources of noise, especially power lines, are crossing the survey area or are very close by, the external electromagnetic noise may contaminate the survey data. In such a case the two receiver coils system could be used very effectively in filtering out this noise.

The reduction of the noise is based on the fact that each of the two receiver coils is receiving noise from the same source and by appropriate selection of the gain of each coil (channel) and subtracting outputs from channels, an order of magnitude reduction of noise could be achieved. A very small penalty in doing this is a negligible reduction of response from targets.

As described in section E.1 the differential channel is calculated by the software in the following way:

$$D = k CH T - CH 3$$

By selecting the depth constant **k** to be 0.28, the channel T output is normalized to have the same "noise gain" as channel 3.

$$D_N = 0.28 CH T - CH 3 = - CHN$$

The differential channel automatically calculated with channel T normalized in this way, is presented as a new channel N. This channel will have target response very similar to the target response of channel 3 and in many cases drastically reduced noise level.

The example of the noise reduction on the actual data using the described technique is illustrated in Figure 9.

Figure 9a shows channel 3 profile from a survey site contaminated by the 60 Hz power line.

Figure 9b shows channel N (normalized differential channel) of the same survey line with the drastic reduction of the noise caused by the power line.

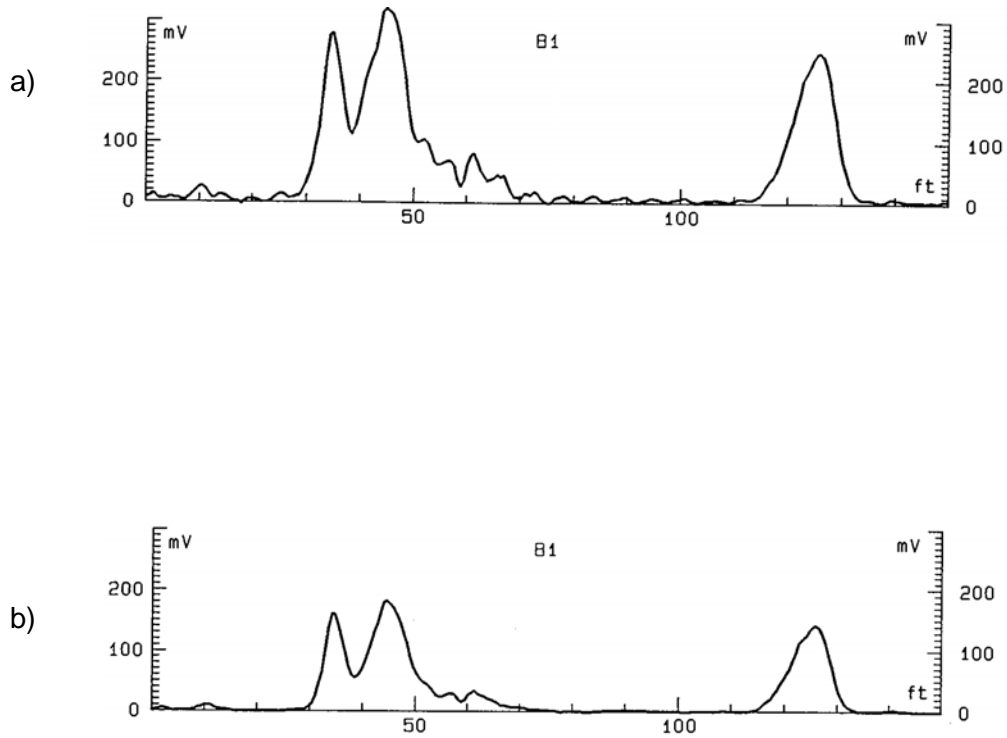

Figure 9

It should be noted that in the case when the differential channel with depth constant  $k=0.28$  is used instead of channel N (automatic noise reduction normalization), the output will be inverted from the standard positive target response.

If the described noise reduction technique is used, and improvement of data quality is noticed, the new channel (channel N) normally replaces channel 3 during the interpretation. Note that the degree of noise reduction will depend on the noise source characteristics and will vary from site to site.

## **F. RESPONSE FROM SOME STANDARD TARGETS**

In order to assist in planning and interpretation of EM61 survey, the following section contains information with the responses from some typical targets like: pipes, balls and 55 (US) gallon (208 l) steel drum.

The first set of graphs gives the response for each of two channels from the targets at the different depths below the EM61 coil assembly. This information can be used initially during the survey planning to assess in estimating the magnitude of response from known target at the specific depth of burial. Later, during the interpretation of the survey results, the same curves could be used to determine the depth of the target, providing that the characteristics of the target are known.

The curves are given separately for steel (or iron) targets, as well as for nonferrous metallic targets like aluminum or copper pipes and balls.

It should be noted that the targets at a specific site will have some of the parameters like: length, wall thickness, or in case of steel target magnetic susceptibility, different from one used to generate given graphs, but in general the response will not be significantly different. In the case of when graphs are used to determine the response from the pipes, the minimum length of pipe has to be over four meters, in order not to make significant error. The depth determination using graphs will be in general more accurate than the method of using apparent depth calculation described in Section E of this manual. Note that diameter of the pipes refer to the outside diameter of the pipe.

The point 3. of the section gives response from 55 (US) gallon steel drum in the vertical position at the different depth below the coil assembly. The response from a horizontal drum will be virtually the same.

The point 4. of this section gives an approximate depth of investigation for different standard targets based on the minimum signal response of 2 mV for the second channel. Since under the normal survey condition, the second channel noise is typically less than 0.5 mV, the threshold level of 2 mV is quite a reasonable value to use.

Note that the following graphs show response from various targets with (below surface) depth assuming the use of 1 x 1 m coils. With the 1 x 0.5 m coils (now standard size sensor) the response will be about 2.5 times higher for targets just below the surface and approximately the same for targets at the depth of 0.5 m and deeper.

As mentioned earlier (Section D), T is channel represent response from the top coil and CH 3 is the channel represent response from the bottom coil, 3<sup>rd</sup> gate.

Figure 10 illustrates measuring geometry used for measurements to generate supplied graphs.

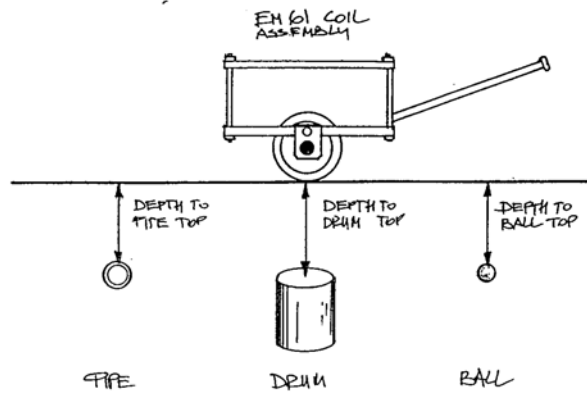

Figure 10

1. Pipe Response with Depth

1.1 Ferrous (Steel, Iron) Pipes

- Steel Pipe 3.4 cm Diameter, 5 Meters Long
- Steel Pipe 4.8 cm Diameter, 5 Meters Long
- Steel Pipe 7.6 cm Diameter, 5 Meters Long
- Steel Pipe 10 cm Diameter, 5 Meters Long
- Steel Pipe 12.7 cm Diameter, 5 Meters Long
- Steel Pipe 17 cm Diameter, 5 Meters Long
- Steel Pipe 20 cm Diameter, 5 Meters Long

# STEEL PIPE 3.4 CM DIAMETER, 5 METERS LONG

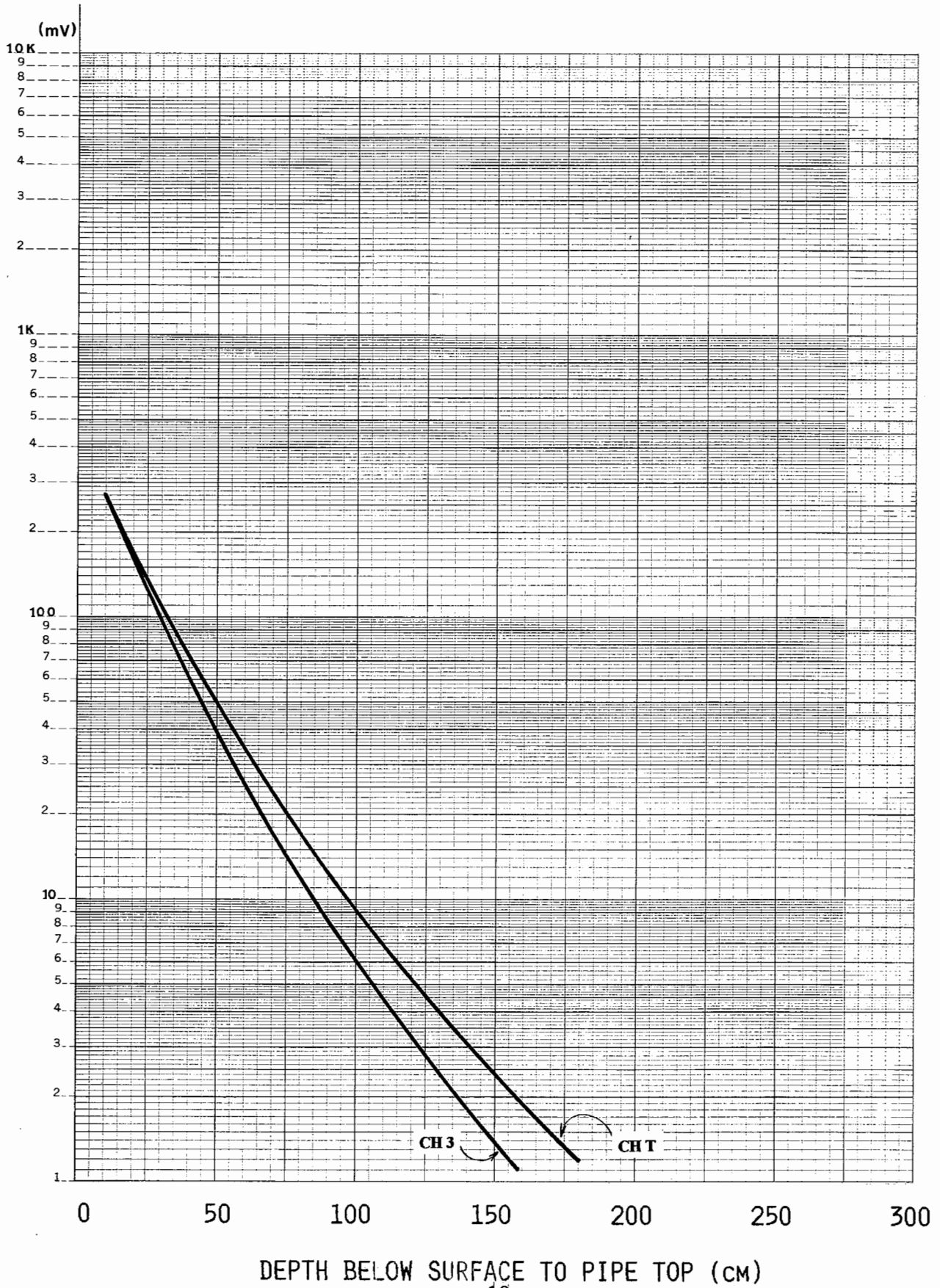

# STEEL PIPE 4.8 CM DIAMETER, 5 METERS LONG

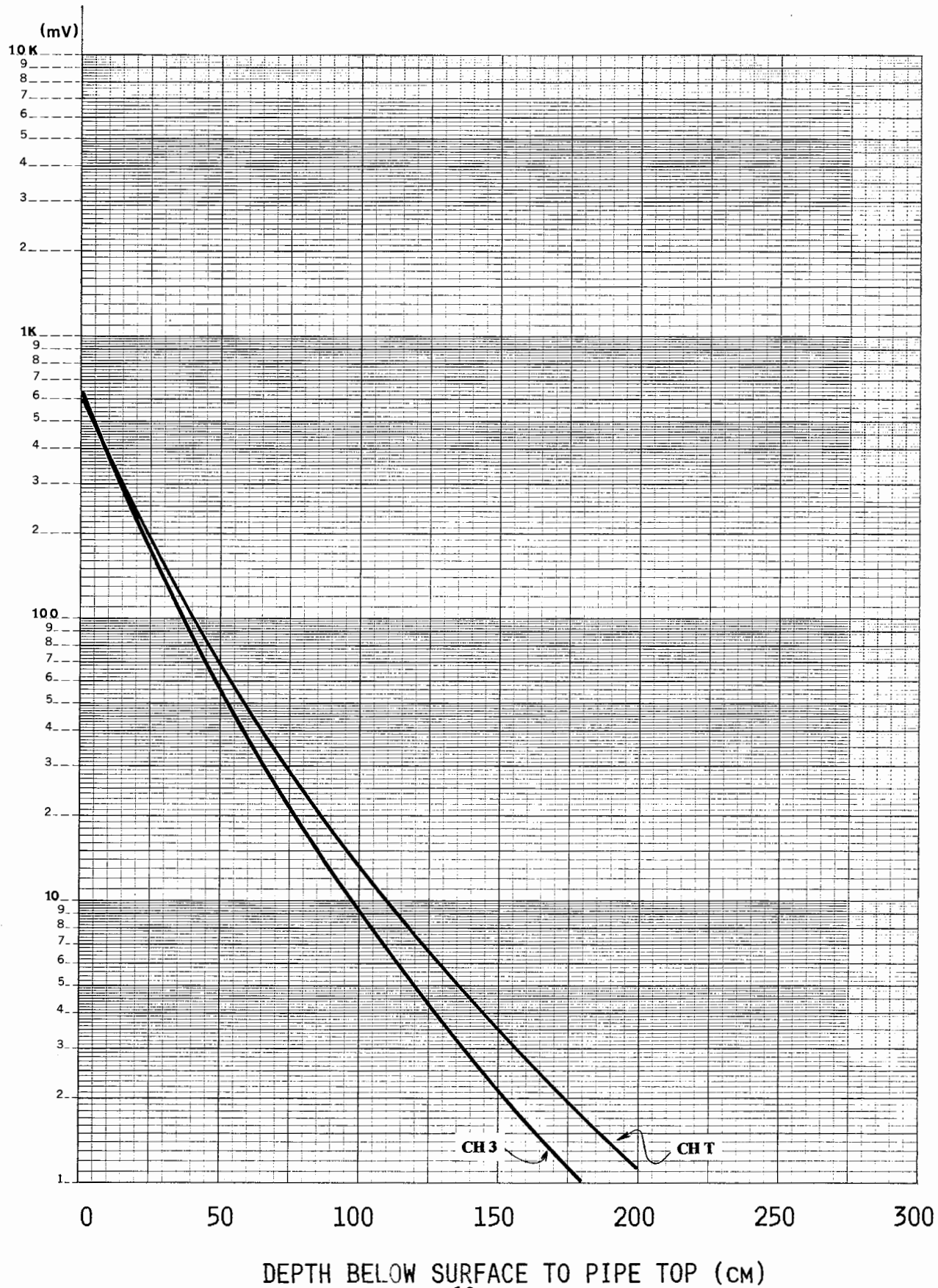

STEEL PIPE 7.6 cm DIAMETER, 5 METERS LONG

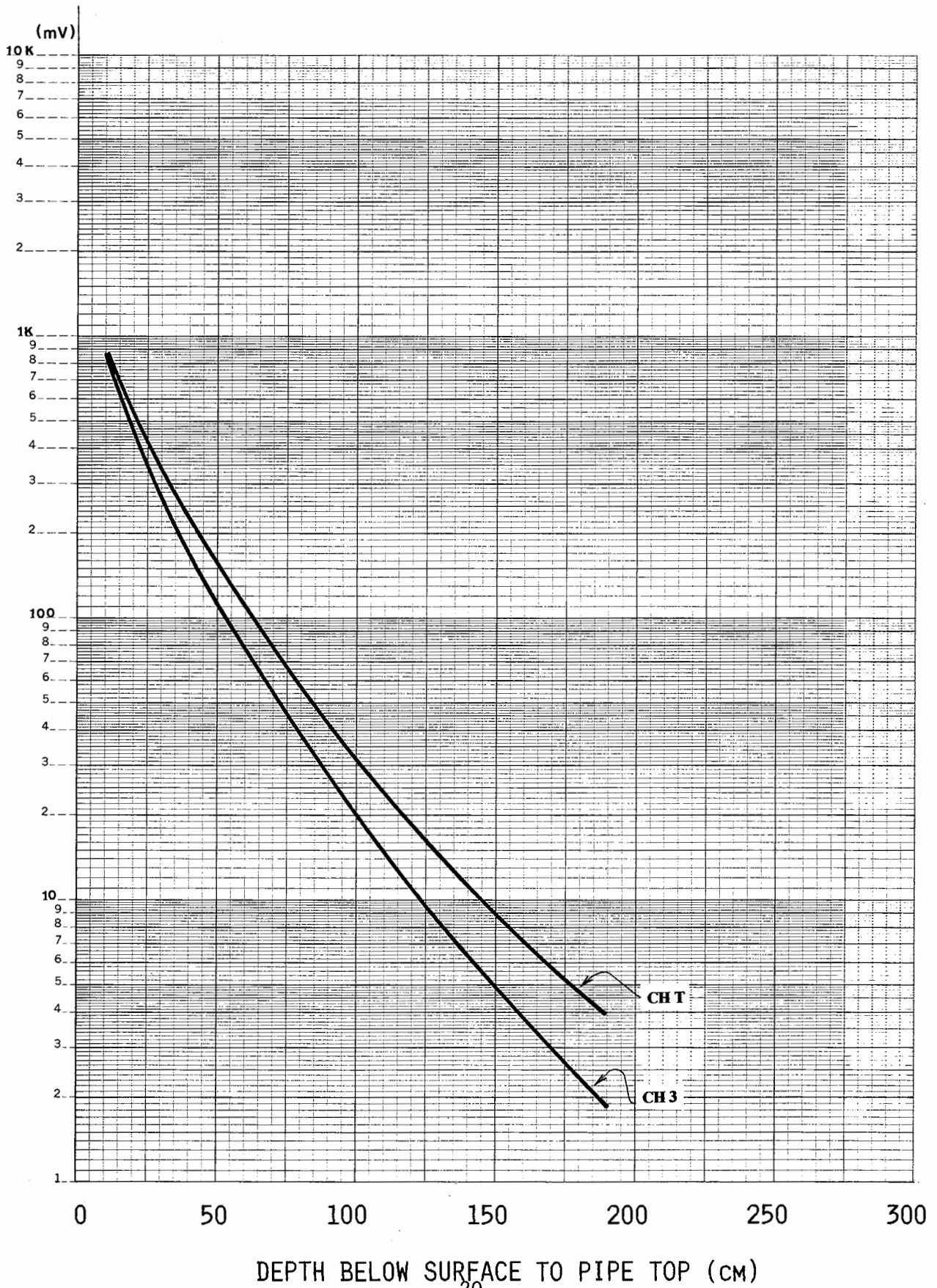



# STEEL PIPE 10 CM DIAMETER, 5 METERS LONG

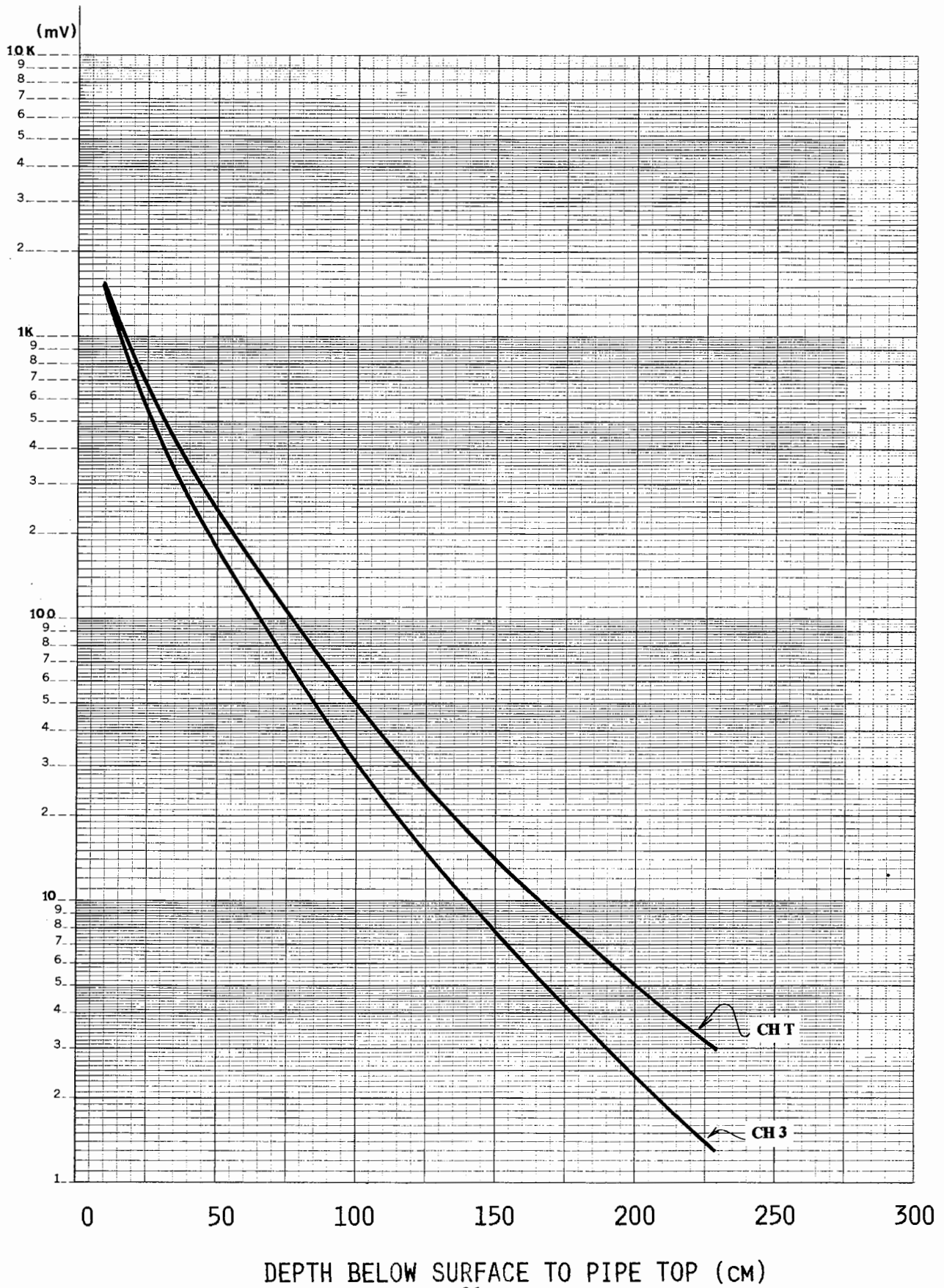

STEEL PIPE 12.7 cm DIAMETER, 5 METERS LONG

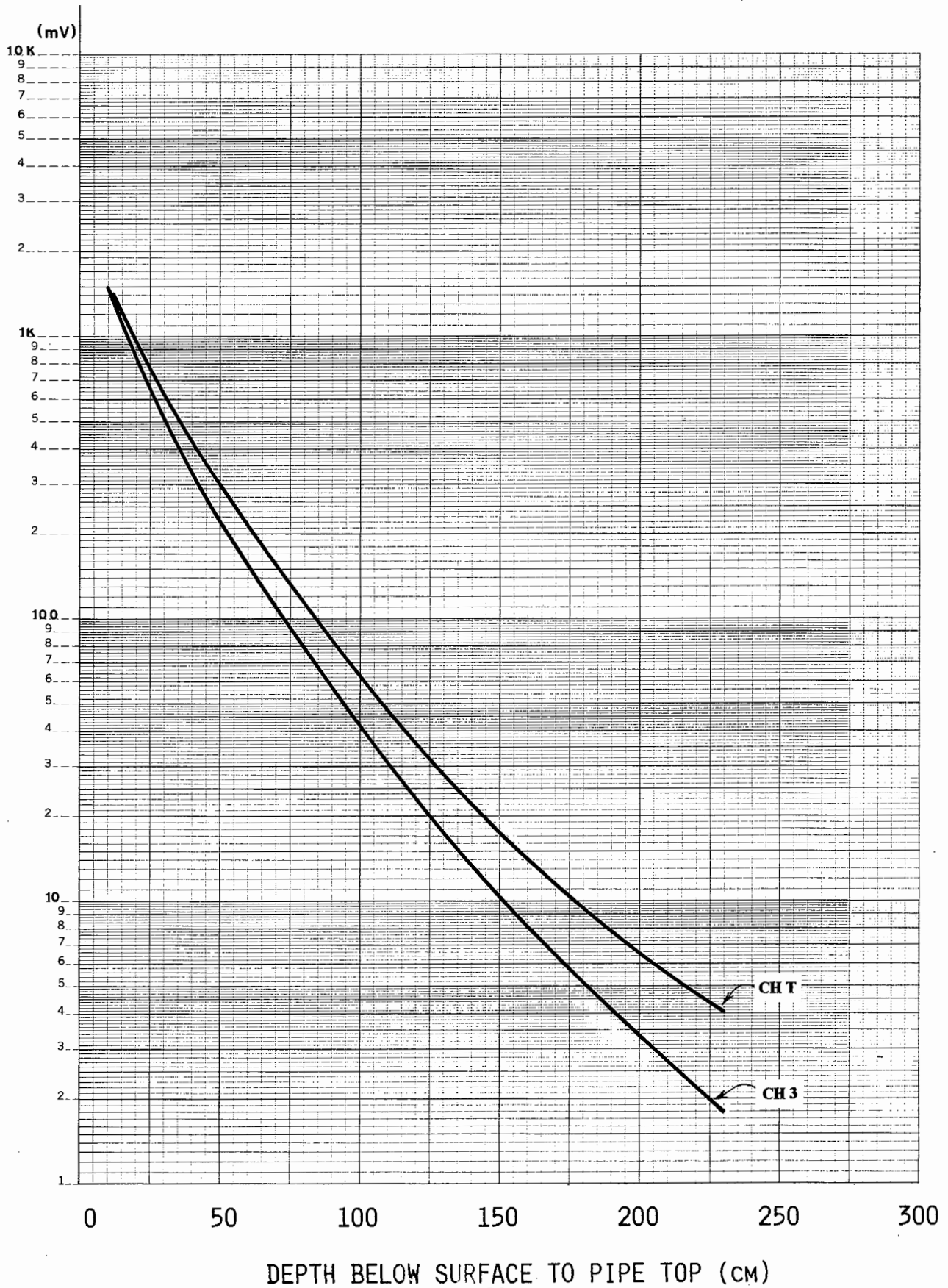

# STEEL PIPE 17 cm DIAMETER, 5 METERS LONG

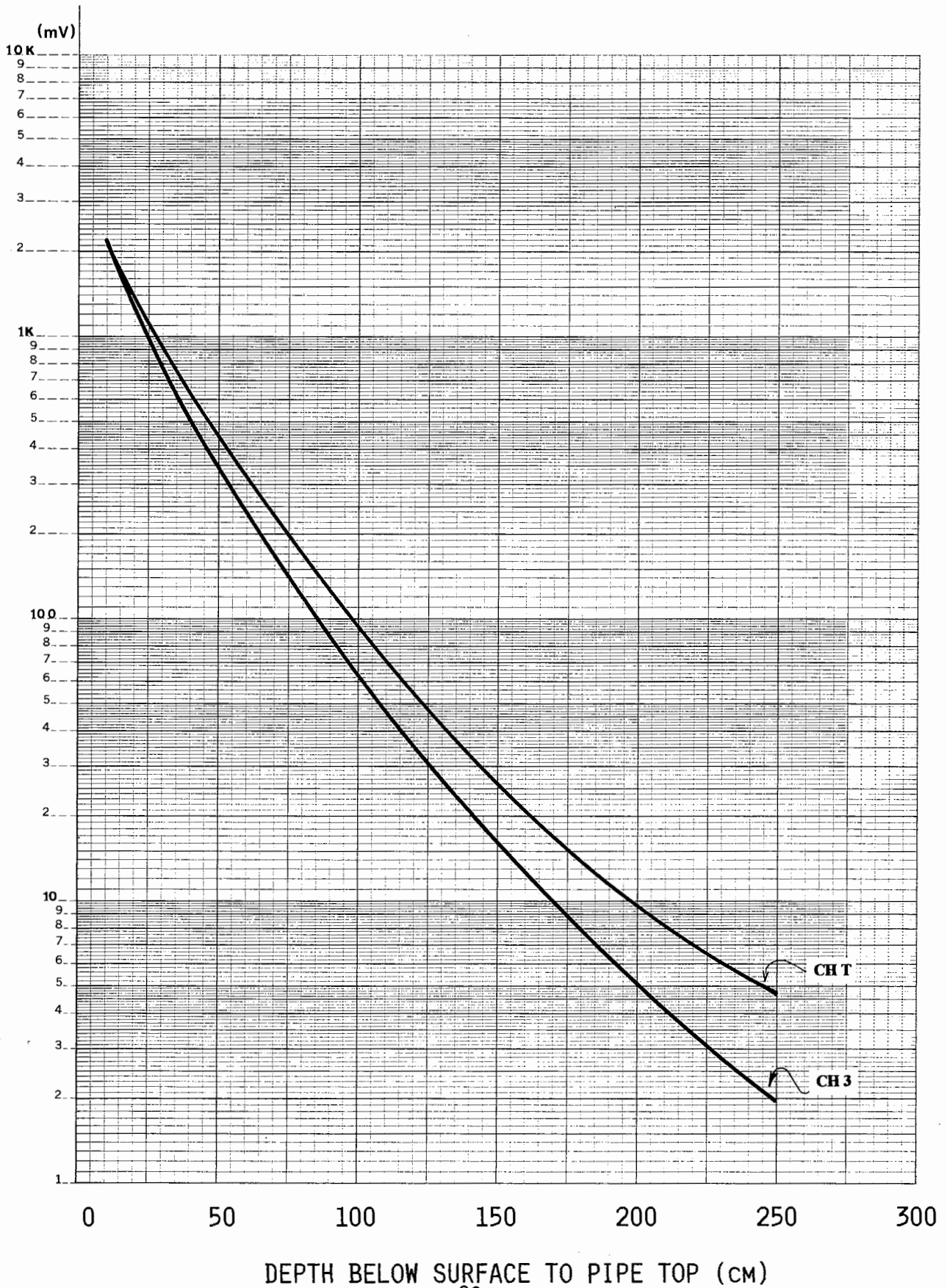

# STEEL PIPE 20 CM DIAMETER, 5 METERS LONG

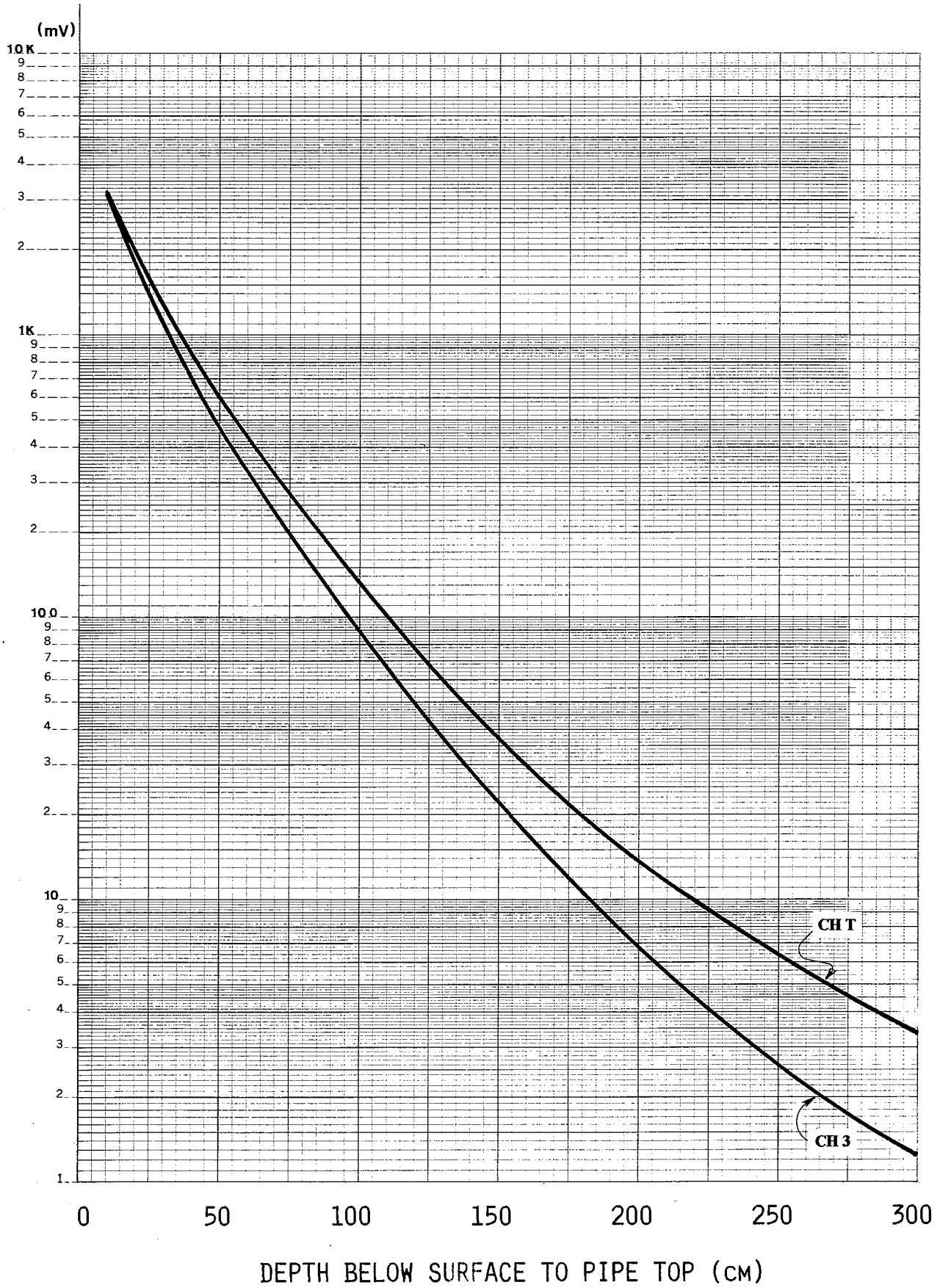

1.2 Nonferrous (Aluminum, Copper) Pipes

- Aluminum Pipe 3.2 cm Diameter, 5 Meters Long
- Aluminum Pipe 5.1 cm Diameter, 5 Meters Long
- Aluminum Pipe 10 cm Diameter, 5 Meters Long
- Aluminum Pipe 20.3 cm Diameter, 5 Meters Long

ALUMINUM PIPE 3.2 CM DIAMETER, 5 METERS LONG

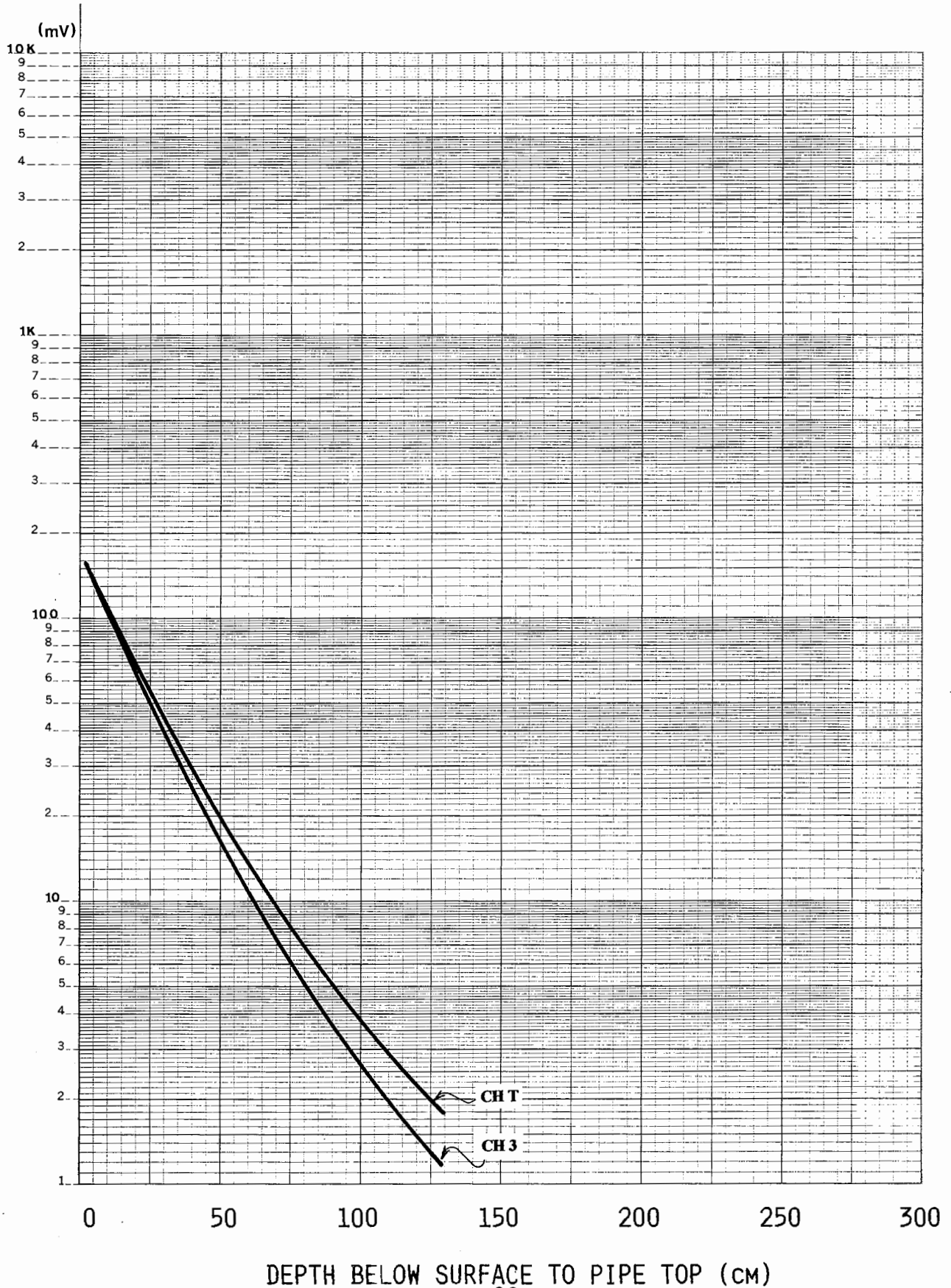

ALUMINUM PIPE 5.1 CM DIAMETER, 5 METERS LONG

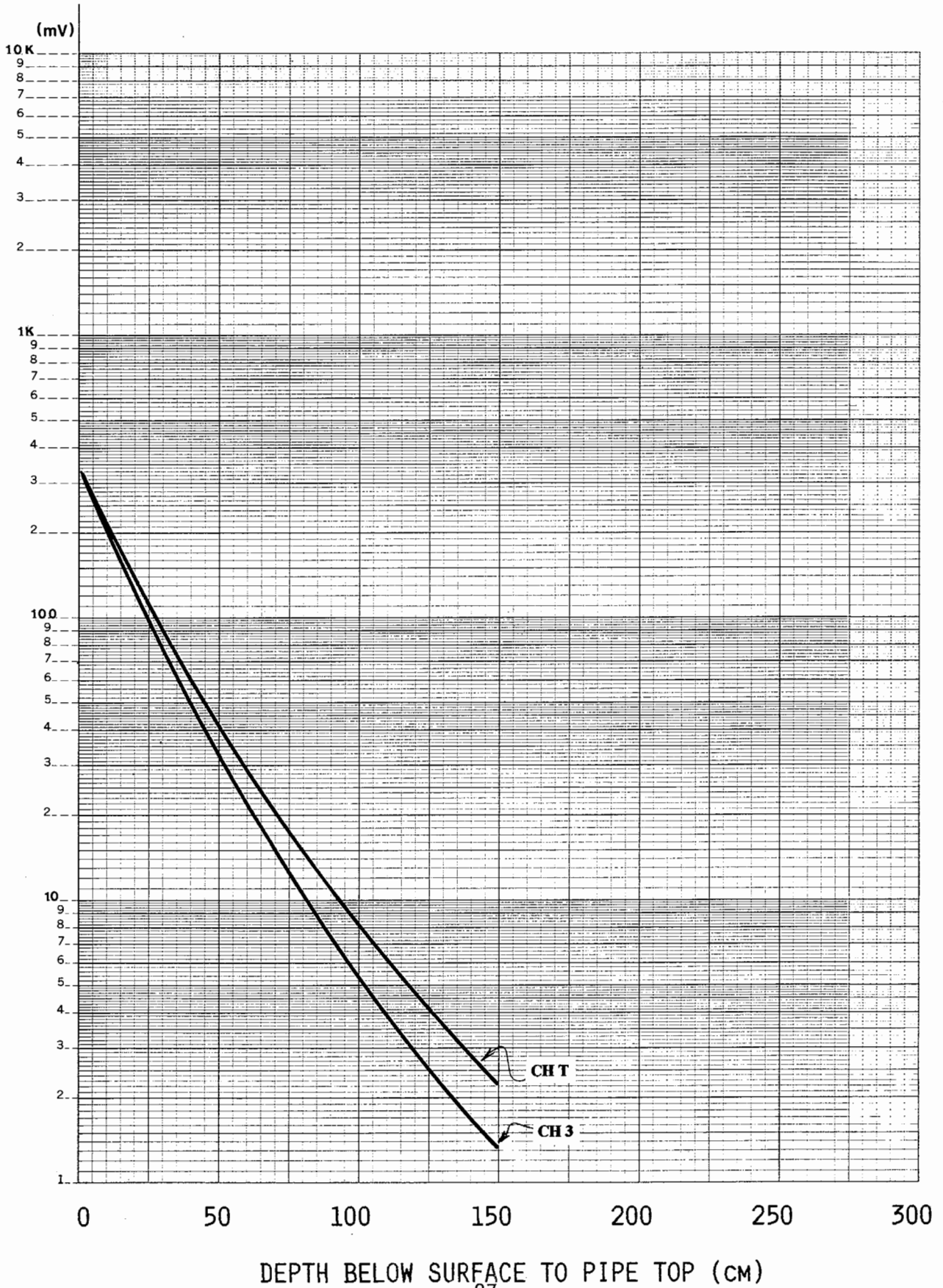

# ALUMINUM PIPE 10 CM DIAMETER, 5 METERS LONG

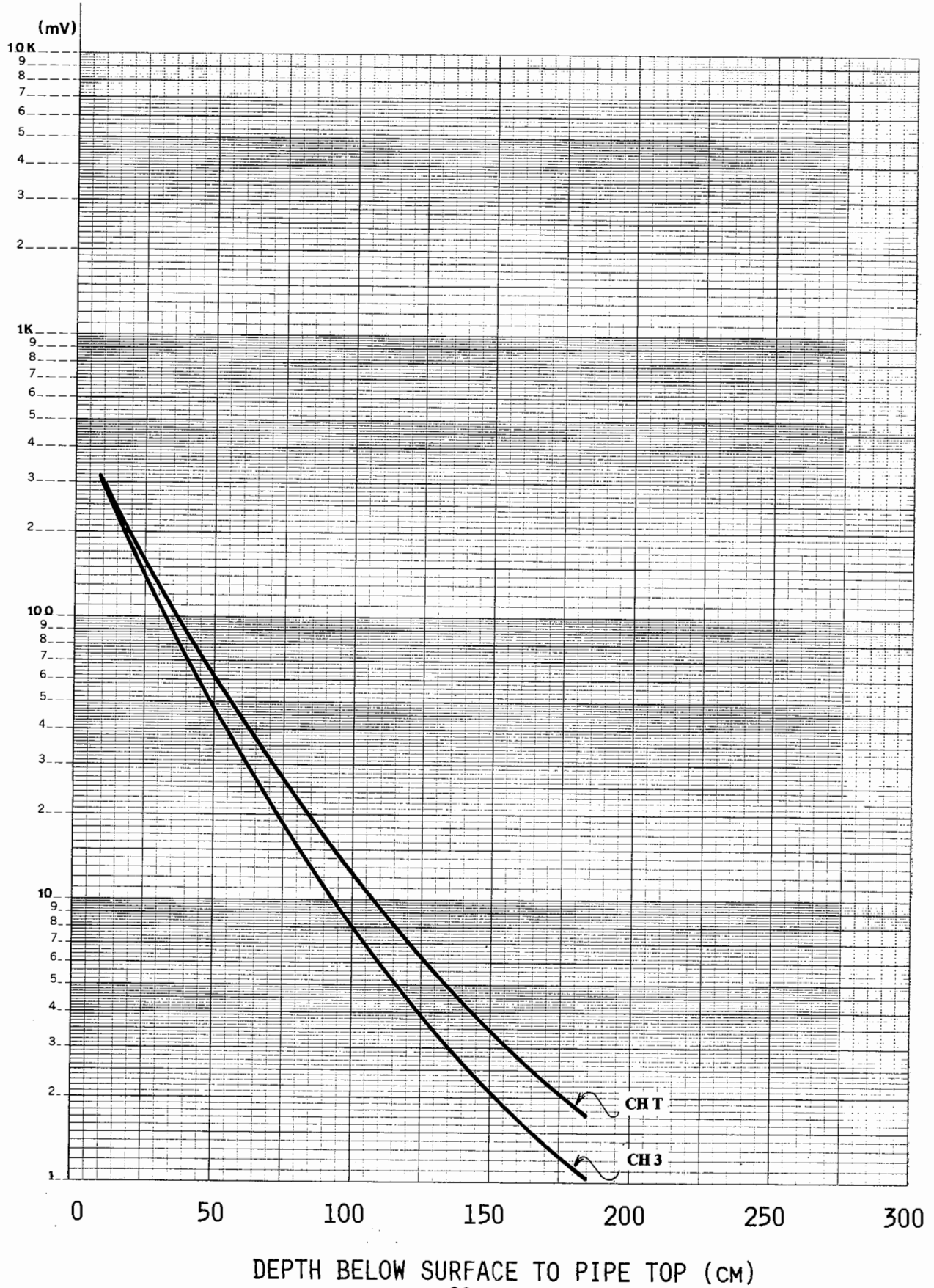



# ALUMINUM PIPE 20.3 CM DIAMETER, 5 METERS LONG

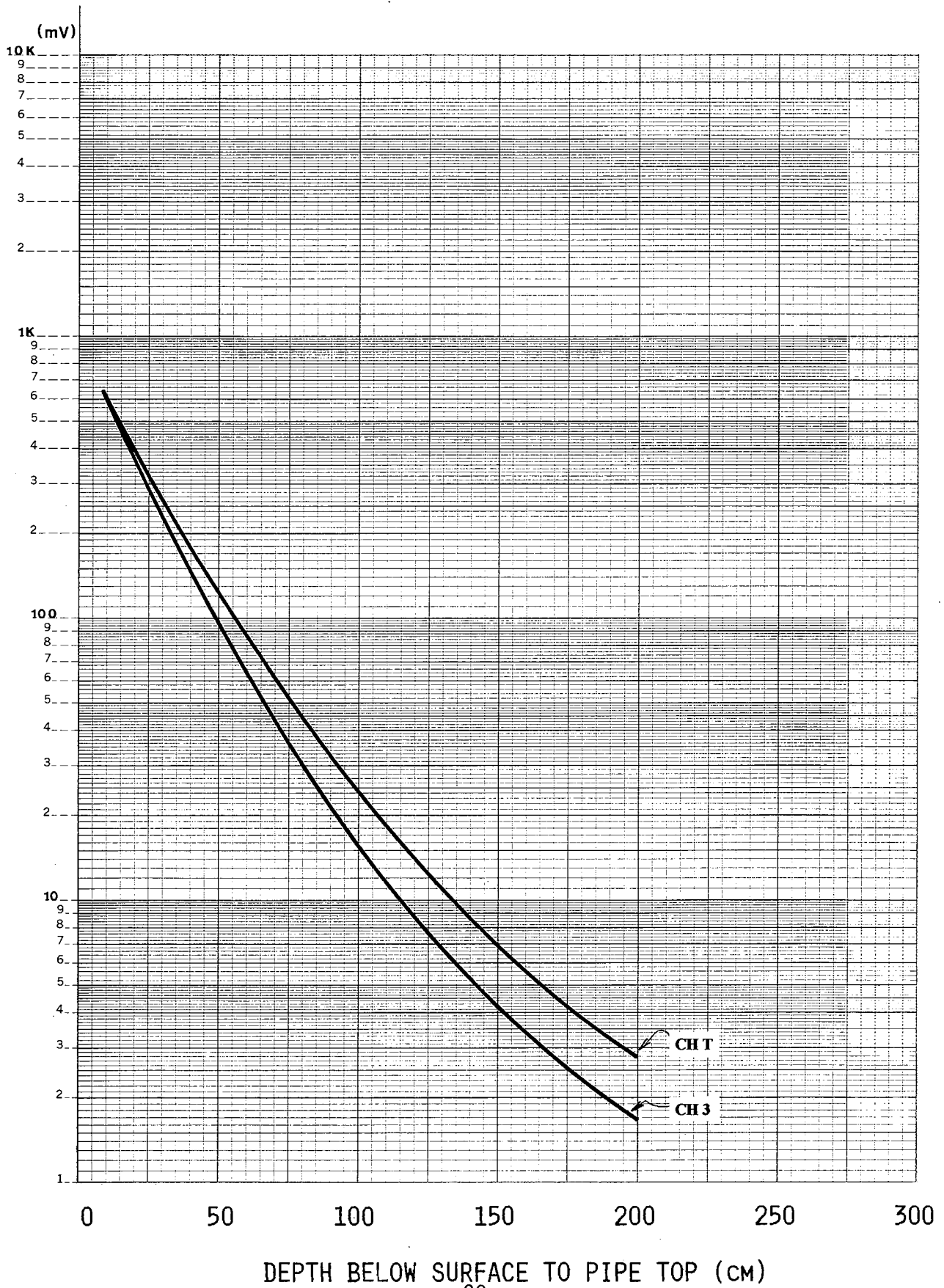

2. Sphere Response with Depth

2.1 Ferrous (Steel, Iron) Spheres

- Steel Ball 9 cm Diameter
- Steel Ball 11.3 cm Diameter
- Steel Ball 12.5 cm Diameter

### STEEL BALL 9 CM DIAMETER

### STEEL BALL 11.3 CM DIAMETER

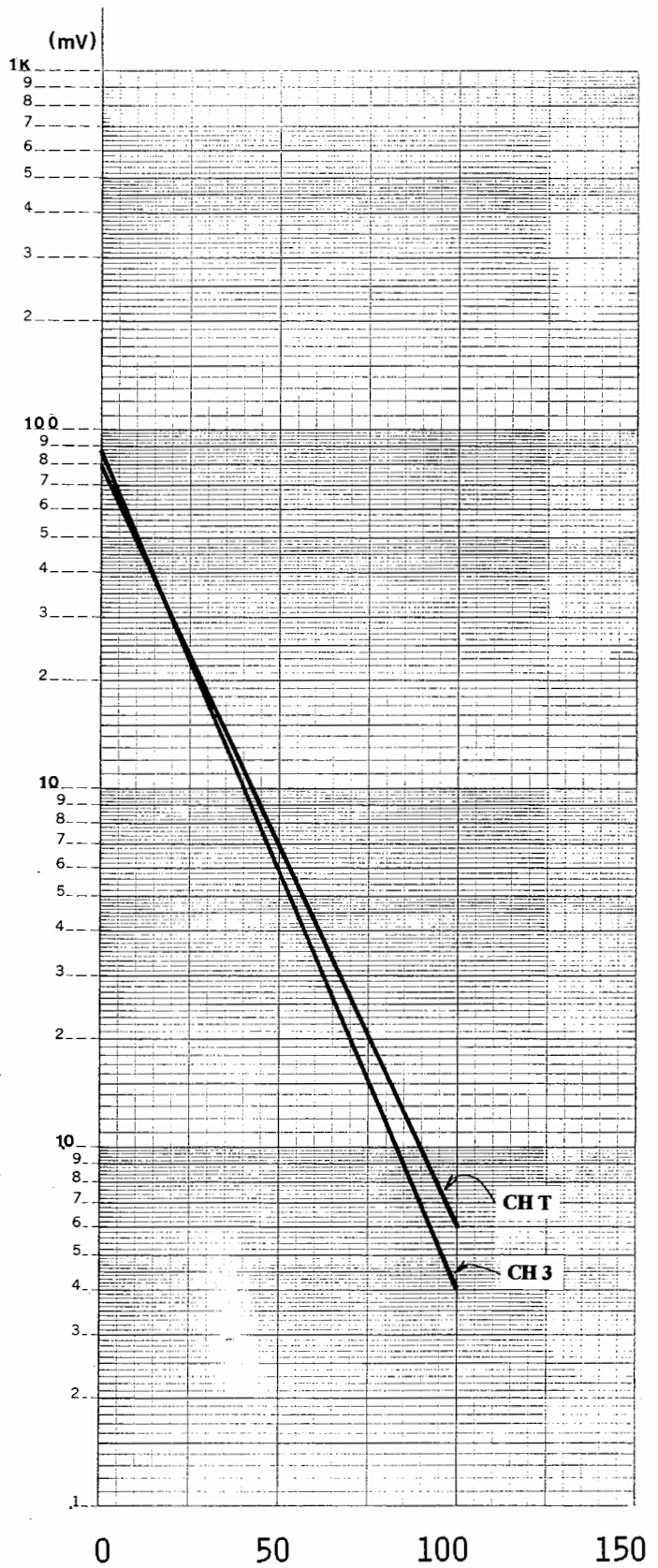
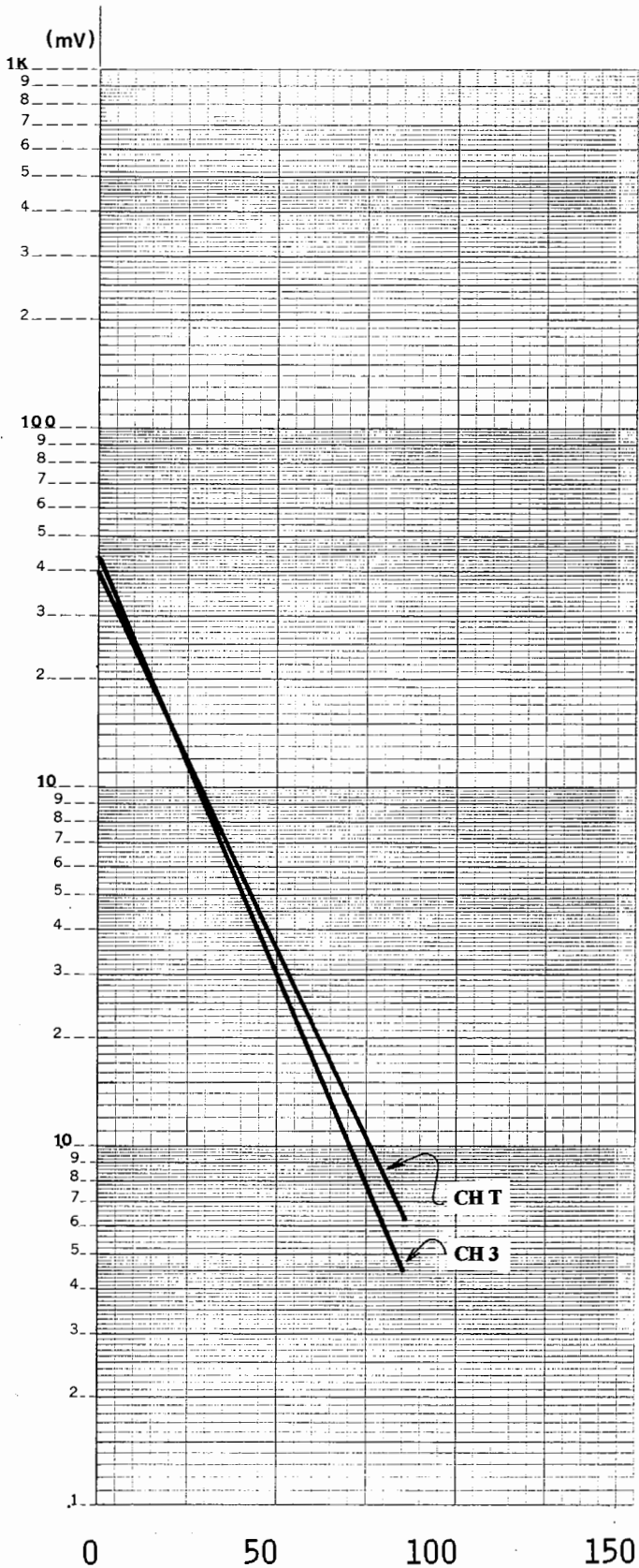

DEPTH BELOW SURFACE TO BALL TOP (cm)

# STEEL BALL 12.5 CM DIAMETER

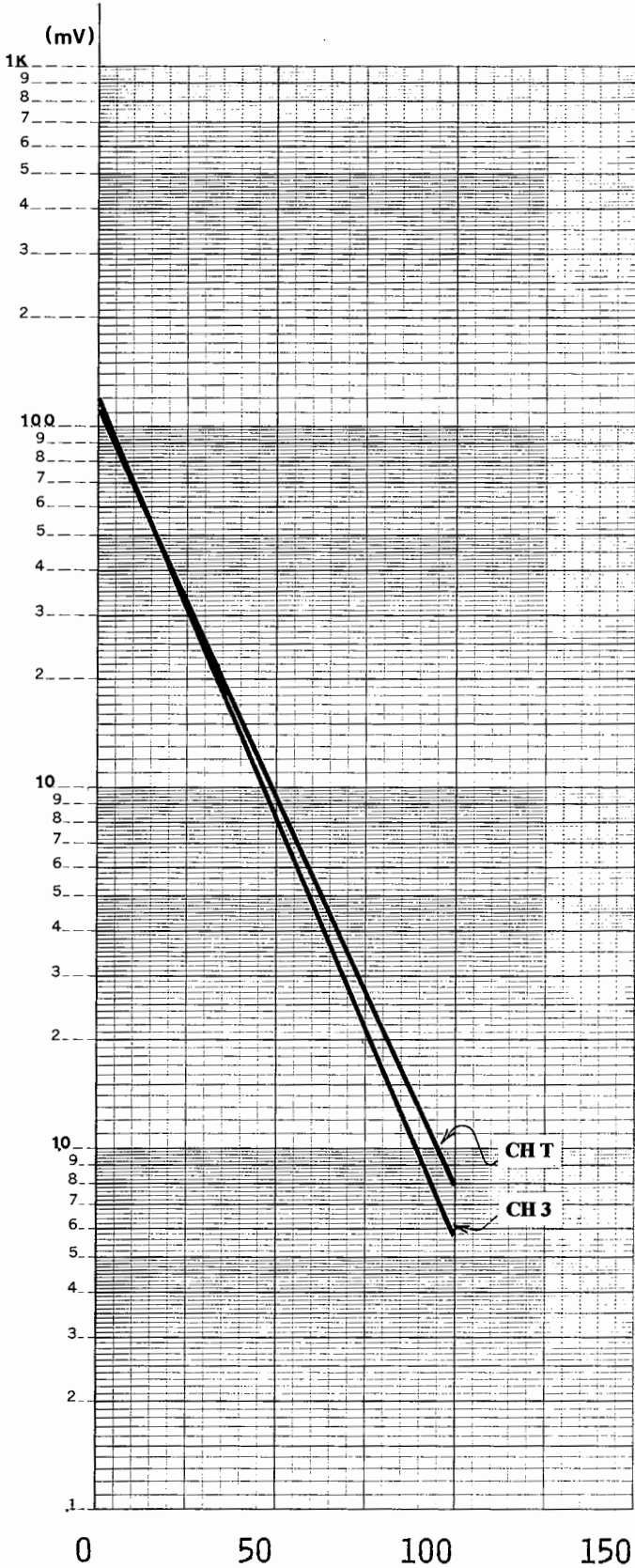

DEPTH BELOW SURFACE TO BALL TOP (CM)

## 2.2 Nonferrous Metallic (Aluminum, Copper) Spheres

- Aluminum Ball 5.1 cm Diameter
- Aluminum Ball 10 cm Diameter
- Aluminum Ball 20 cm Diameter

### ALUMINUM BALL 5.1 CM DIAMETER

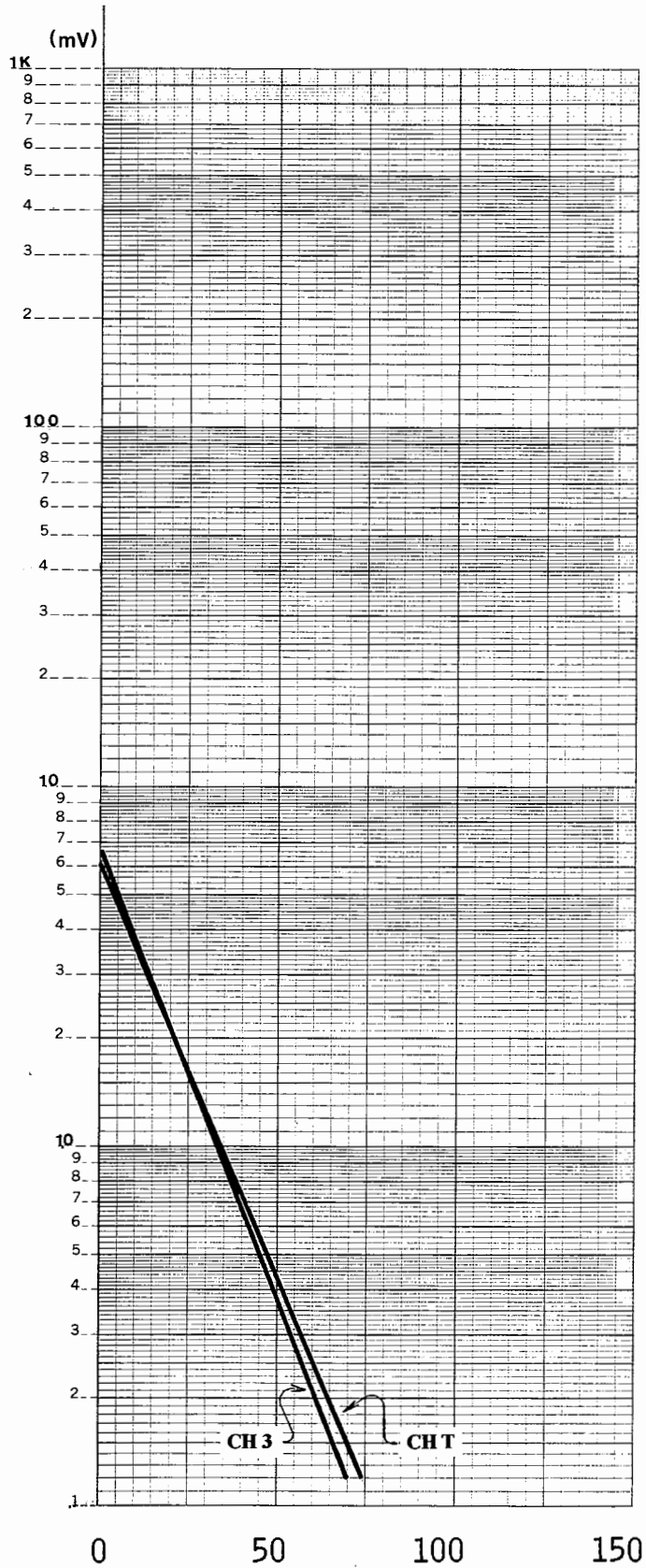

### ALUMINUM BALL 10 CM DIAMETER

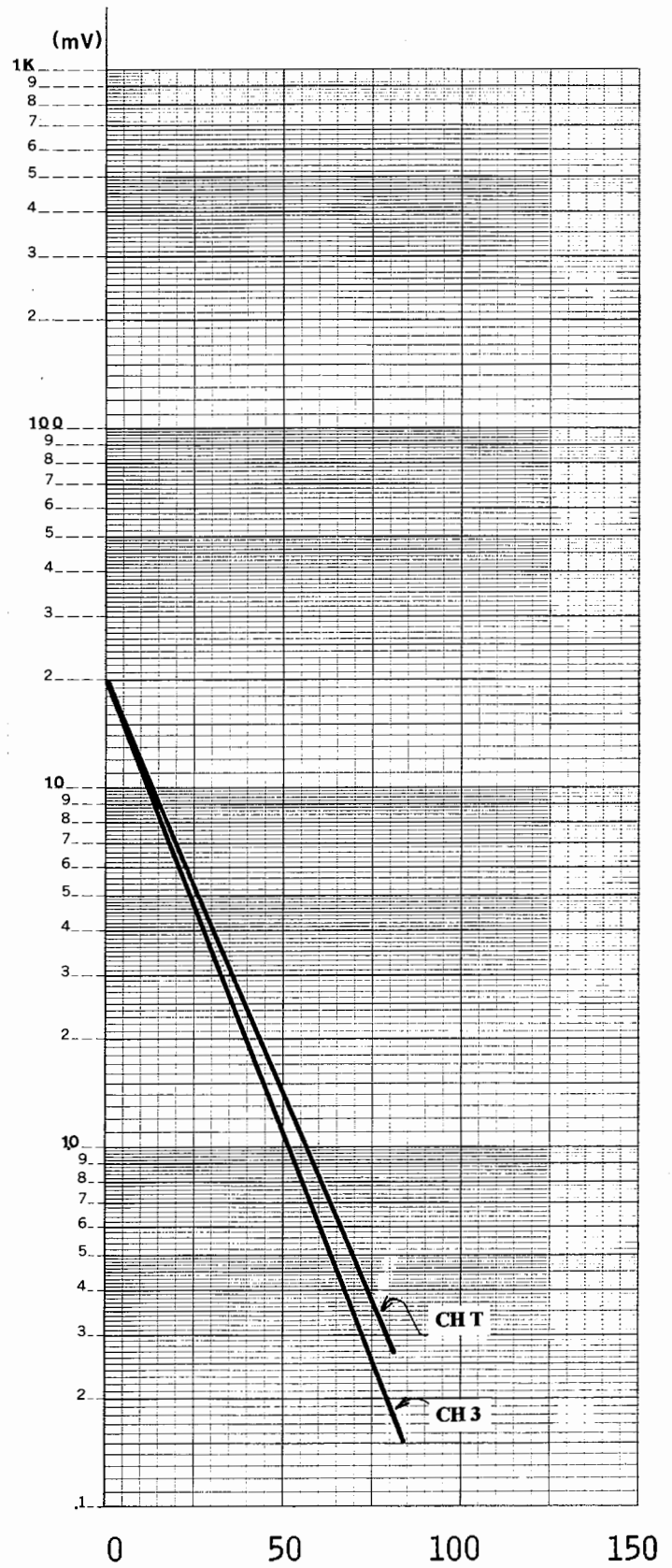

DEPTH BELOW SURFACE TO BALL TOP (cm)

# ALUMINUM BALL 20 CM DIAMETER

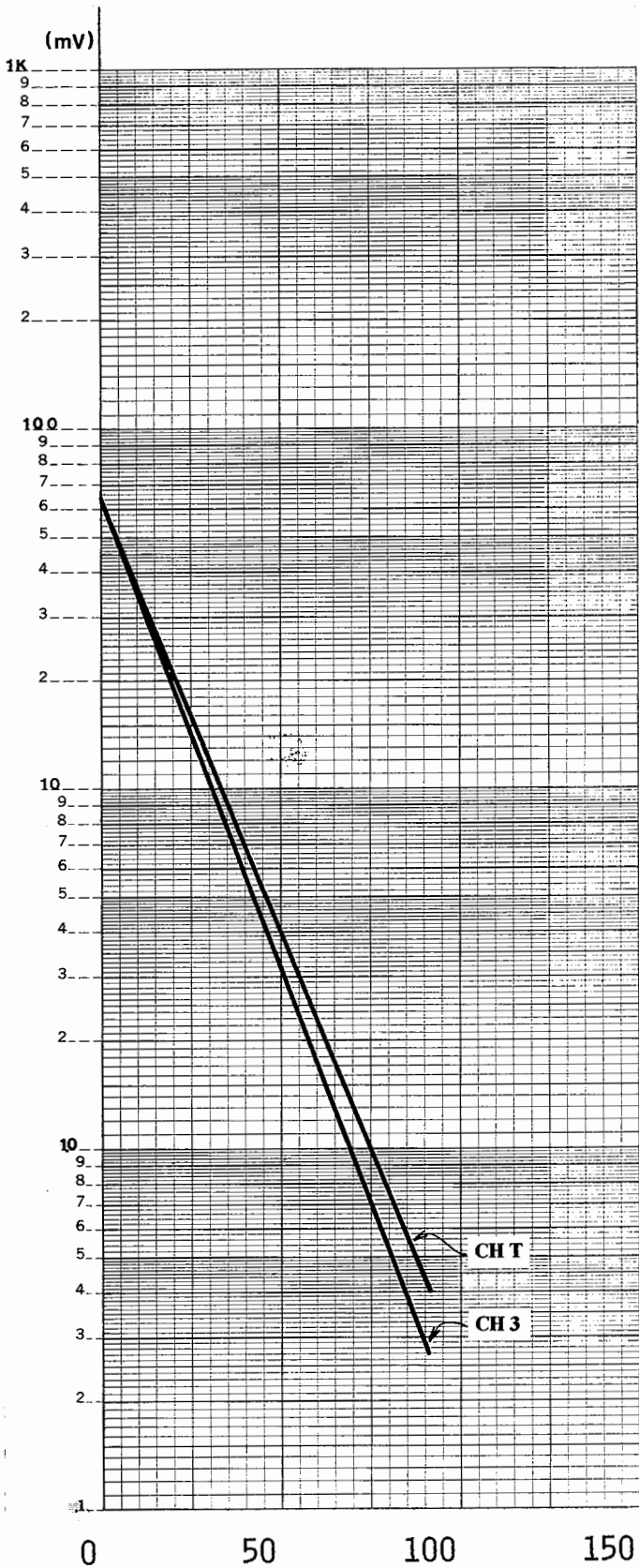

DEPTH BELOW SURFACE TO BALL TOP (cm)

### 3. 55 GALLON STEEL DRUM RESPONSE WITH DEPTH

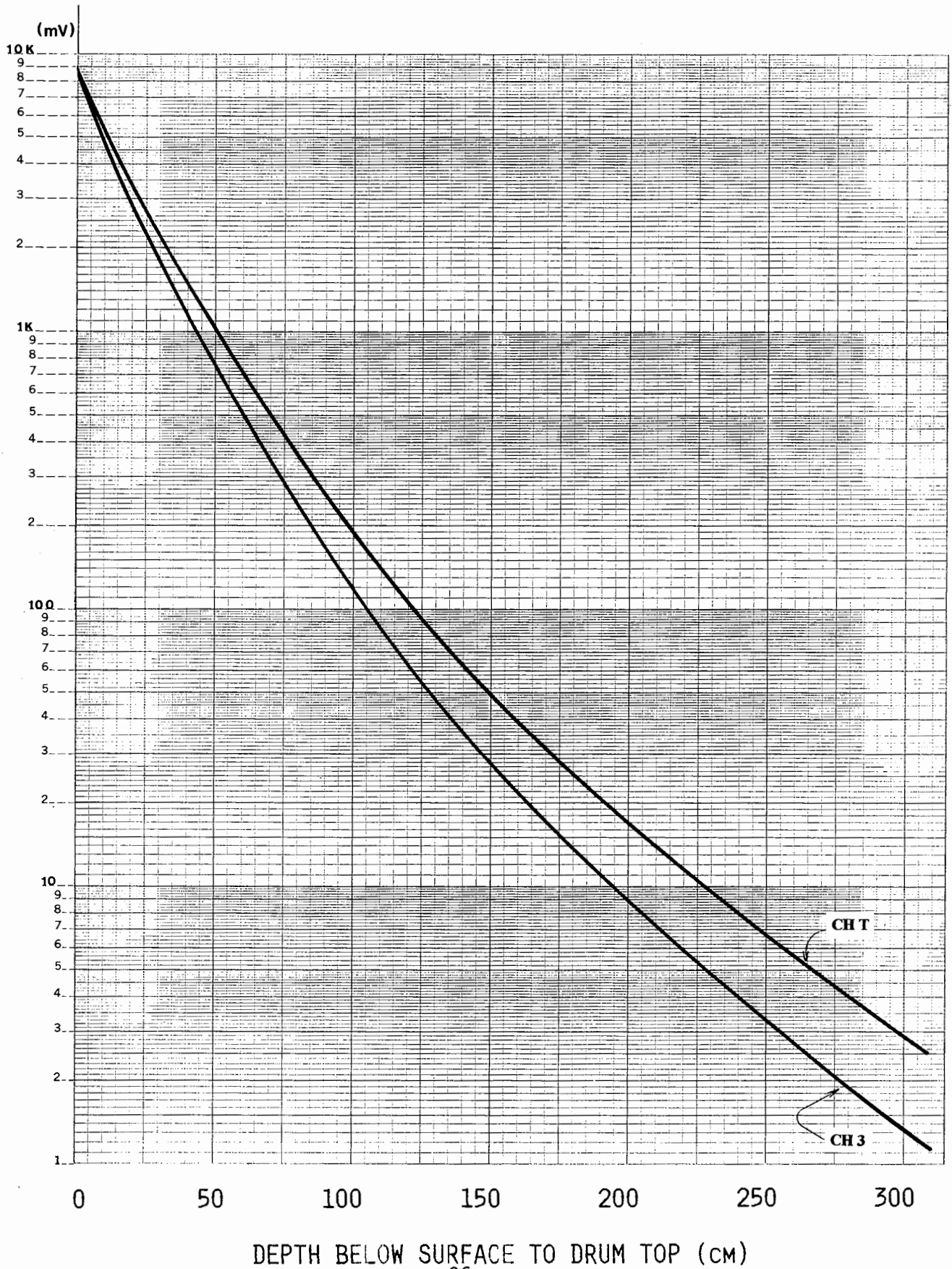



#### 4. DETECTABILITY VS TARGET DIAMETER

##### 4.1 STEEL PIPE

DEPTH BELOW SURFACE  
TO PIPE TOP (CM)

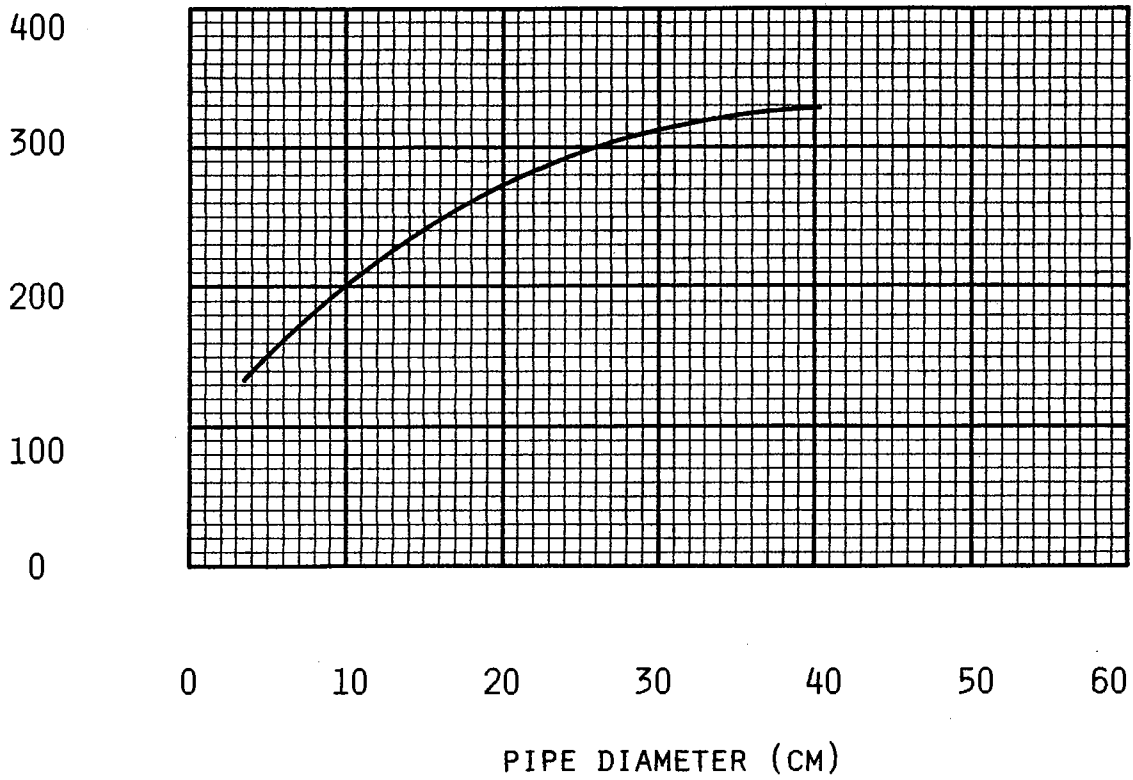

## 4.2 ALUMINUM PIPE

DEPTH BELOW SURFACE  
TO PIPE TOP (CM)

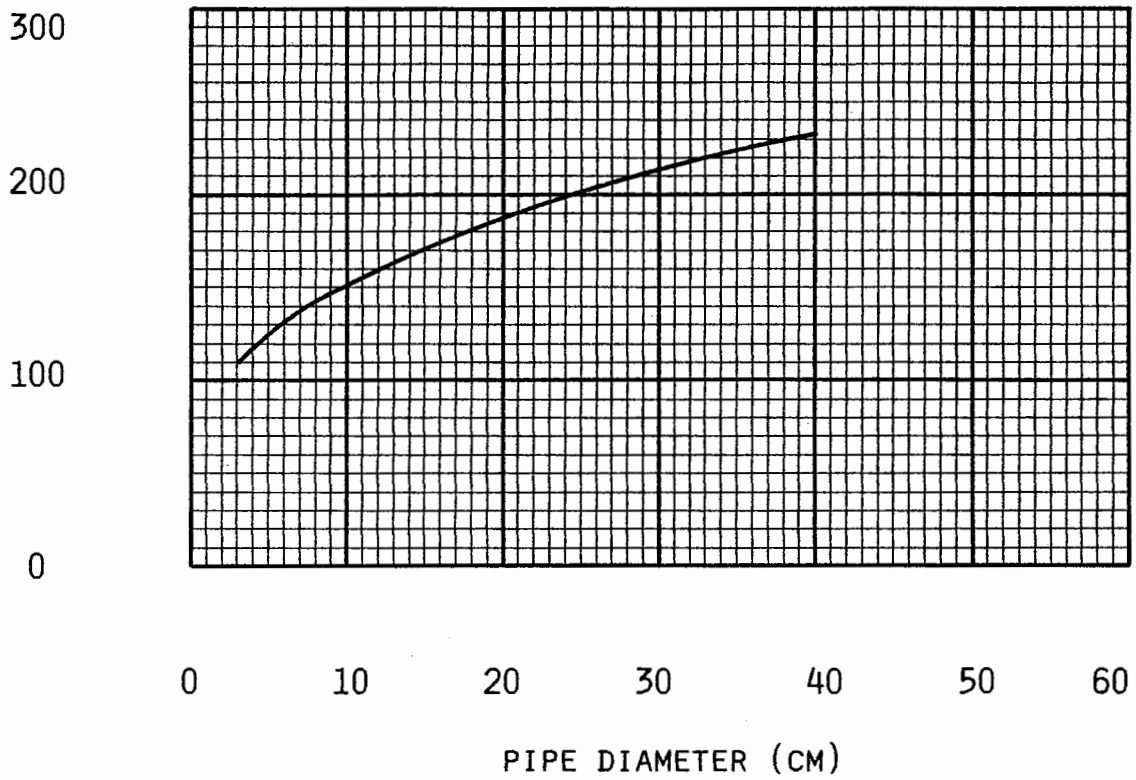

### 4.3 STEEL BALL

DEPTH BELOW SURFACE  
TO BALL CENTER (CM)

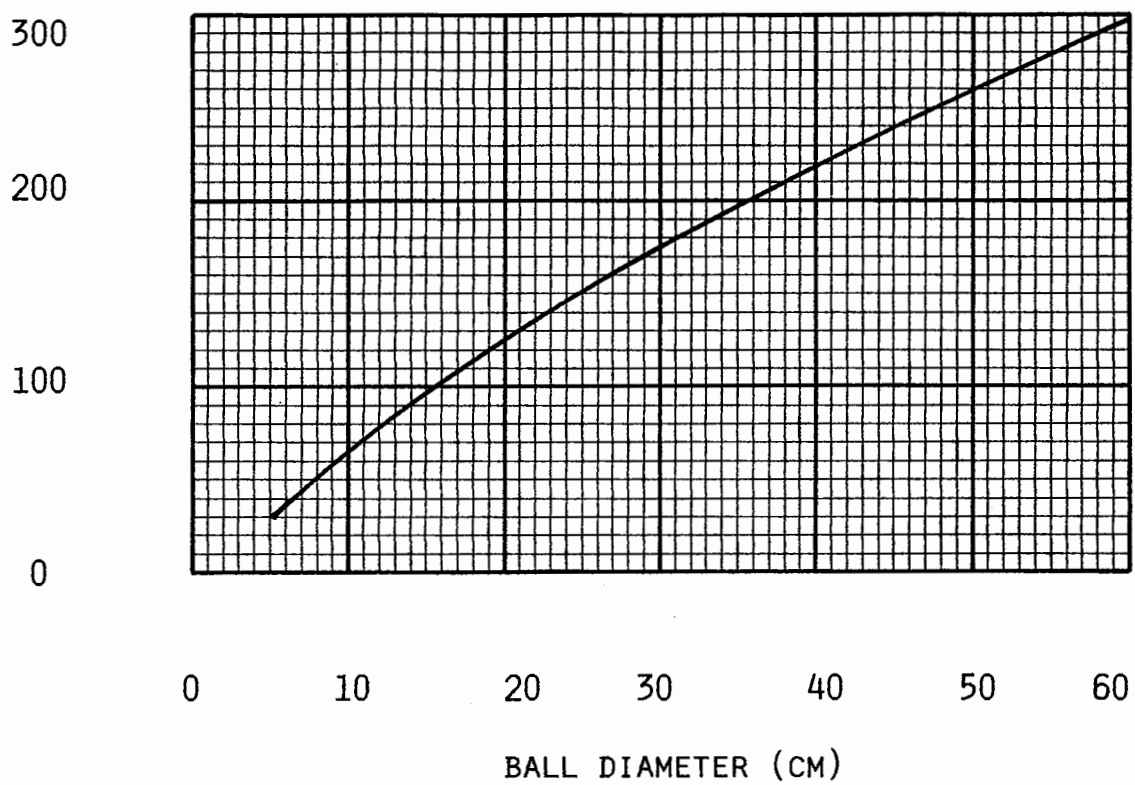

#### 4.4 ALUMINUM BALL

DEPTH BELOW SURFACE  
TO BALL CENTER (CM)

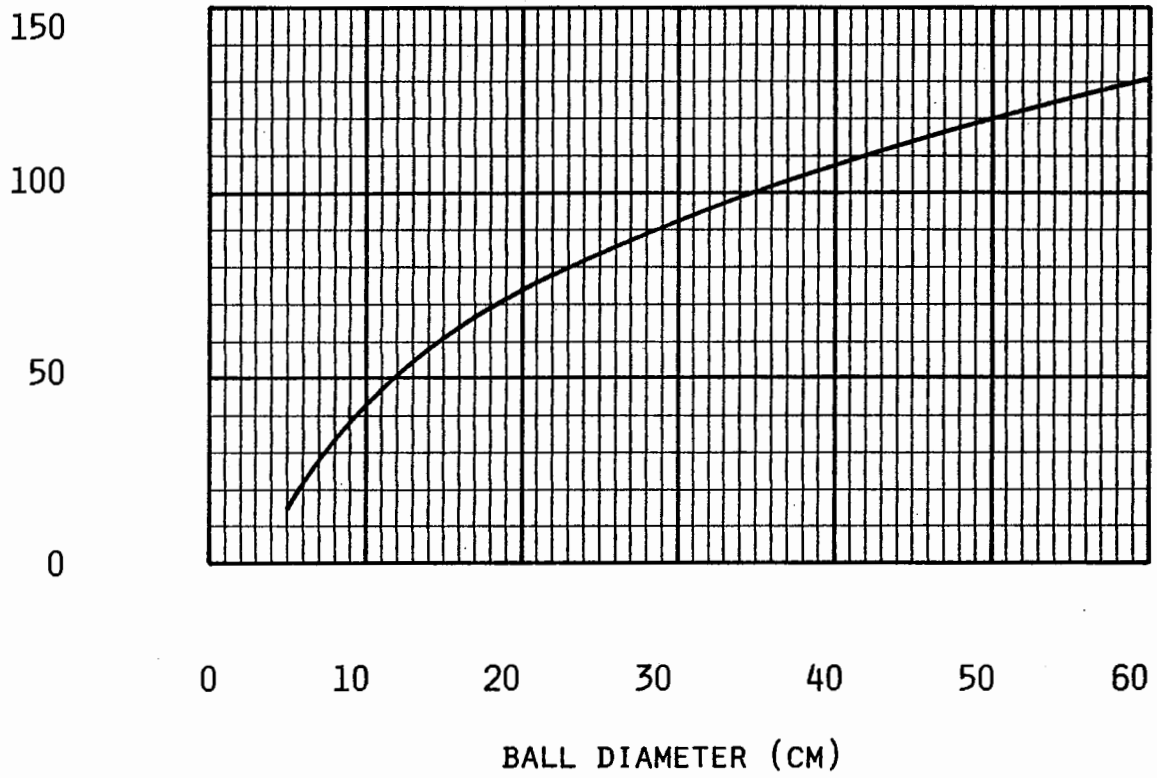

## **G. OPERATIONAL PROCEDURES AND QUALITY CONTROL RECOMMENDATIONS**

# Operational Procedures and Quality Control Recommendations

## TABLE OF CONTENTS

	<u>Page</u>
<b>A INTRODUCTION .....</b>	<b>1</b>
<b>B THEORY .....</b>	<b>1</b>
<b>C PLANNING .....</b>	<b>3</b>
C.1 Research Site History	3
C.2 Research Site Geology	3
C.3 Preparation of Geophysical Investigation Plan	3
<b>D AMPLITUDE RESPONSE AND DEPTH OF DETECTION .....</b>	<b>4</b>
D.1 Introduction	4
D.2 Geophysical Noise	7
D.3 Filtering Noise	8
<b>E EQUIPMENT FUNCTIONALITY AND QC TESTS .....</b>	<b>9</b>
E.1 Out of Box Equipment Tests	9
E.2 Initial Geophysical Instrument Checks	10
E.3 Suggested Daily Instrument Checks	12
E.4 Examination of Repeat Data	12
<b>F DATA ACQUISITION .....</b>	<b>13</b>
F.1 Survey Design Elements	13
F.2 Operating Procedures for EM61 and EM61-MK2	15
<b>G NAVIGATION .....</b>	<b>19</b>
G.1 Introduction	19
G.2 Conventional Navigation	19
G.3 Global Positioning System (GPS)	20
<b>H DATA STORAGE AND TRANSFER .....</b>	<b>22</b>
H.1 Recommended Field Storage and Transfer Procedures	22
<b>I DATA PROCESSING AND ANALYSIS .....</b>	<b>22</b>
I.1 Introduction	22
I.2 Field Editing Data	23
I.3 Preprocessing	24
I.4 Processing and Target Selection	25
I.5 Advanced Processing	26

## TABLE OF FIGURES

Figure B.1 Time Domain Theory	1
Figure D.2 Fort Ord Detection Depths –EM61	7
Figure E.1 Example Test Site	11
Figure F.1 Instrument Warm Up	16
Figure I.1 Example of Chevron Affect	24

## TABLE OF TABLES

Table D.1 Detection Depths	6
Table E.1 Instrument Test Table	13
Table F.1 Line Spacing Recommendations	13
Table F.2 Station Spacing Recommendations	14

## TABLE OF EQUATIONS

Equation I.1 Geonics Depth Calculation for 1 x 1 meter system	27
Equation I.2 Geonics Depth Calculation for 1 x 0.5 meter system	27

## A Introduction

This document is intended to provide an example of quality control procedures for the use of the Geonics EM61-MK2 and EM61 instruments. Its primary goal is to introduce procedures for surveying that will maximize data quality and promote documentation of data collection and processing procedures used by consultants. Geonics Limited would like to acknowledge for their considerable input into this document, Naeva Geophysics Inc., Geosoft Inc. and the U.S. Army Engineering and Support Center. Additional input has been provided by Peeter Pehme and Dr. John Greenhouse of Hyd-Eng Geophysics (Dillon Consulting).

## B Theory

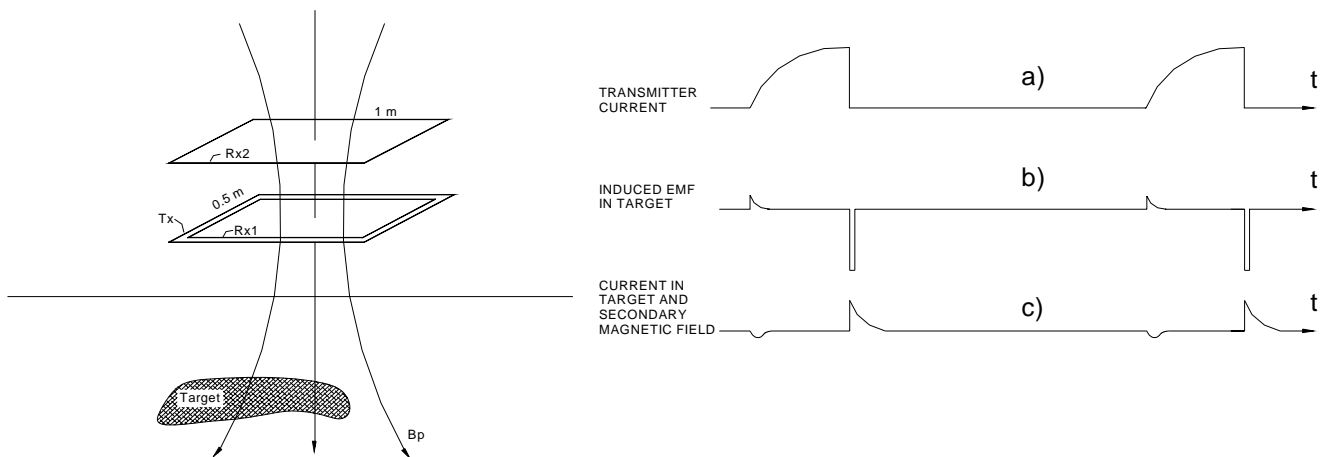

**Figure B.1 Time Domain Theory**

The EM61-MK2 is a time domain metal detector manufactured by Geonics Limited of Mississauga, Ontario. The instrument is used for the detection of ferrous and non-ferrous metallic objects primarily in the environmental/engineering and unexploded ordnance (UXO) applications.

The following is a short description of the time domain electromagnetic induction principles as it applies to metal detection.



The EM61-MK2 consists of a coincident transmitter (Tx) and receiver (Rx) coil and a second receiver coil located 30 centimeters above the Tx/Rx coil. The Tx coil is energized by a pulse of current and the Rx coils measure the target response decay at fixed moments in time.

Figure B.1 shows schematically the EM61-MK2 coil configuration, transmitter current and induced and received signals.

The current in the transmitter coil is a series of pulses as indicated in Figure B.1a. When the transmitter current is turned off an electromagnetic force (EMF) is induced in the conductive target (Figure B.1b) with a characteristic decay which is a function to conductivity, magnetic susceptibility, size and shape of the target. The decaying current generates proportional secondary magnetic field (Figure B.1c) which time rate of change is measured by the main receiver coil (Rx 1).

The function of the second receiver coil (Rx2) is twofold: First having suitably adjusted gain in respect to the main receiver coil (Rx1), one can subtract the output signal of Rx2 from Rx1 to substantially reduce the response from near-surface targets (i.e. scrap metal) compared with deeper targets. Secondly, the relative signal output from the two receiver coils is compared to determine the depth to small targets (i.e. targets whose dimensions are small compared with the size of the coils)

The EM61-MK2 can provide output from four time gates geometrically spaced in time after the termination of the transmitter pulse. This feature allows discrimination between different types of targets based on the time-decay rate of the response. This discrimination technique works well for simple shaped targets with all three dimensions (x, y and z) being approximately equal, it has also shown to be useful, however, at some military test ranges. For additional description of the EM61-MK2 and how it can be used for discrimination please refer to Geonics Limited Technical Note TN-33<sup>1</sup>.

---

<sup>1</sup> Technical Note TN-33, Miro Bosnar, Geonics Limited, March 2001.

## **C Planning**

The following list for planning geophysical surveys is limited to a brief description of major elements for brevity. These elements are standard for planning any geophysical investigation and have been referred to in various documents. Many of these elements are considered to be standard by the Environmental and Engineering Geophysical Society (EEGS).

### **C.1 Research Site History.**

- a. Review all previous investigation reports. The previous usage of the site and the likely composition and depth of targets should be defined in this stage of planning.
- b. If possible, conduct interviews with personnel formerly assigned at site. One goal of the interviews may be to obtain local information and anecdotes on the suspected target areas.

### **C.2 Research Site Geology.**

- a. Review surficial geology: Obtain geologic maps and literature for the site.

### **C.3 Preparation of Geophysical Investigation Plan.**

- a. Determine survey type: Random, Fixed Pattern Transects, or Detailed. Survey type is dependent on the objectives of the investigation, whether the goal is to conduct Geophysical Sampling, Geophysical Mapping, or a more detailed Geophysical Investigation.
- b. Determine methods and procedures proposed for the investigation: Methods and procedures are determined by consideration of all factors described above, as well as type and expected depth of targets. Topography, vegetation, and the presence of cultural features must also be considered in the selection of instruments: standard, hand held, and high power.
- c. Determine required data density, based on type of investigation: Size and depth of expected targets, and method used for detection will dictate minimum requirements for line and station spacing.

- d. Define method of navigation, means of location and mapping: Describe procedures and equipment to be used in data collection to ensure accurate location of data points. Means of location and mapping points, whether by GPS, ultrasonic or through conventional surveying of grid corners should be defined.
- e. List survey equipment and services: Prepare list of items needed to perform survey, and services required. List should include sources of supplies and rental sources of equipment that may provide backup instruments in the event of instrument malfunction.
- f. Describe Data Storage, Transfer and Archiving.
- g. Describe Quality Control procedures to be performed: steps to ensure proper instrument function, accurate mapping and location of anomalies, and repeatability.
- h. Describe Procedures for Reacquisition: methods of reacquisition of anomalies.
- i. Define Work Schedule, project completion, schedule of deliverables to client.

## **D Amplitude Response and Depth of Detection**

### **D.1 Introduction.**

Test measurements have been made at numerous sites on inert ordnance items at various depths and orientations. It has been shown that the approximately dipolar amplitude response of small target items is inversely proportional to the distance of separation between the sensor and the anomaly source. Theory as well as testing has also revealed that ferrous targets vertical ferrous targets generally have a greater EM amplitude response than horizontal and the opposite is true for nonferrous objects. Table 4.1 depicts a number of EM61 amplitude response measurements over horizontal ordnance items and calibration spheres at various depths.

- a. The typical noise level for a well maintained and calibrated EM61-MK2 is about 1 to 1.5 mV (for the EM61 or channel #3 of the EM61-MK2). Therefore, the depth at which each ordnance type response reaches signal that is two time of this noise level is defined as the detection depth for that object. At various locations across a remediation site, the

local terrain noise will reduce the actual detection depths. It is inappropriate to speak of a 'typical detection depth' for a particular instrument without considering terrain noise.

The standard EM61-MK2 cannot detect single objects at depths much greater than 3-4 meters. For objects greater than 3 meters, the high power and/or larger transmitter loops are generally recommended.

**EM61-MK2 / EM61-MK2-HP (High Power)**

**UXO Detection\* Depths**

Target Type	Detection Depth Below Surface (cm)			
	<i>Vertical Target Orientation</i>		<i>Horizontal Target Orientation</i>	
	MK2	MK2-HP	MK2	MK2-HP
20 mm Projectile	58	100	8	15
20 mm Cartridge	68	120	38	72
40 mm Dummy Round	68	120	66	118
60 mm Mortar	88	145	64	110
81 mm Dummy Round	108	175	95	150
105 mm Projectile	152	230	114	177
155 mm Projectile	200	300	140	210
500 lb. Bomb	500	700	320	445

\* detection at 2mv response in 1 mv noise environment

**Table D.1 Detection Depths**

- b. The Ordnance Detection and Discrimination Study (ODDS) conducted by Parsons Engineering Science for the Corps of Engineers at the former Fort Ord in California, in July 2000, generated excellent examples of static test data using vertical gradient magnetometer and EM (time domain and frequency domain). Figure 4.2 was compiled using ODDS data, illustrating their findings on maximum depths of detection for 187 different ordnance items, ranging in size from a 14.5 mm trainer M181 projectile, to a 155 mm projectile. It is important to note that all of these measurements were recorded using a special platform, raised above the ground surface with low ambient noise. The following comments can be made:

- (1) Maximum depth for each item was the calculated maximum depth of detection for soils at Fort Ord. For the EM61, best and worst orientations were generally with the long axis of the item vertical, and horizontal, respectively.
- (2) Readings as low as 1.49 mV were recorded as detectable for the EM61, and 1.31 mV for the EM61-HH. While these numbers may be useful in calculating detection depths in an ideal environment, in a real survey noise levels from a variety of sources will probably necessitate a higher threshold. Additionally, the better signal to noise ratio and earlier time gates of the EM61-MK2 will improve the detection level of both smaller and deeper targets.

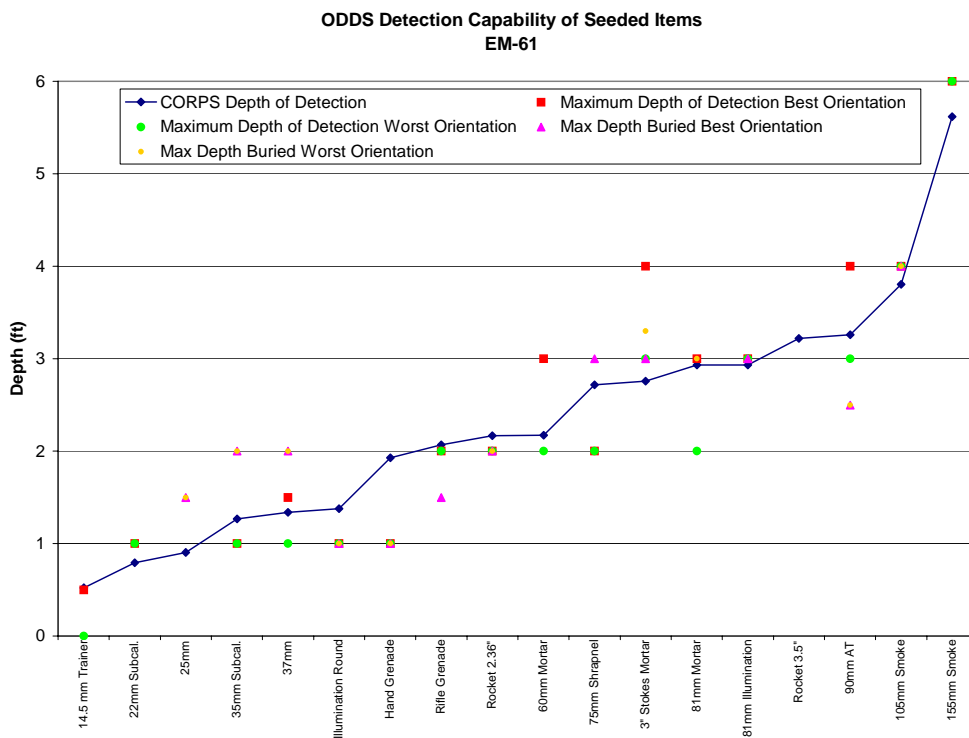

**Figure D.1 Fort Ord Detection Depths –EM61**

## D.2 Geophysical Noise

- a. The responses of targets may be detected only if they are greater than the background noise level. Geophysical noise (not sensor sensitivity) is therefore the limiting factor in determining thresholds and detection depths. The noise encountered in geophysical surveys is generally of four types:

- Instrument Noise
  - Ambient (electromagnetic) Noise
  - Motion or Dynamic Noise (mechanical vibration, etc.)
  - Terrain Noise (site-specific, repeatable response of rocks, soils, and metal clutter)
- b. Instrument noise is internal and intrinsic to the instrument. It is generally, by design, of much lower amplitude than other sources of background noise. Ambient noise is induced in the sensors by outside electromagnetic fields in its vicinity. It can be caused by nearby powerlines, motors, radio transmitters, generators, radar, and other electrical or electromagnetic devices. GPS electronics and radios are common sources of ambient noise.
- c. Motion noise is caused by mechanical vibration of the instrument and metal on the operator or instrument (wheels, etc.). It can occur anytime the instrument is moving. Varying the EM61-MK2's coil(s) orientation while surveying may generate a high frequency (depending on rate of change) response which can make interpretation of smaller targets difficult. This "noise" likely results from varying the instruments sensors in a manner that the coupling with the earth's magnetic field is changed.
- d. Terrain noise is caused by real and repeatable instrument response to highly magnetic rocks and soils, and metal clutter. The term terrain refers to the sources of response that are actually present in or on the ground. It is usually the largest noise component and often the limiting factor in geophysical detection and interpretation.

### **D.3 Filtering Noise.**

- a. One frequently hears references to 'filtering the noise'. Short wavelength and long wavelength noise can be suppressed by filtering. Unfortunately, terrain noise often contains the similar wavelengths as target responses and therefore cannot be easily removed by spatial filtering.
- b. Static (bench) tests measure the sum of instrument and ambient noise (and also instrument drift). Dynamic tests along an actual survey line are necessary in order to

measure motional and terrain noise. A repeated dynamic test survey line also measures positional variation.

## **E Equipment Functionality and QC Tests**

The recommended equipment tests and frequency of testing is summarized in Table 5.1.

### **E.1 Out of Box Equipment Tests**

Non-functioning equipment arriving at the site will cause delays in surveying. Worse yet, improperly functioning equipment may result in unreliable data, increasing false alarms or missing targets. For these reasons out of box equipment tests are recommended to ensure instruments are operating correctly:

- a. Inventory and inspect all components. Geonics provides a packing list showing all included components. Check that each item is present, and inspect cables, connectors, harnesses, etc. for signs of wear or damage. Spare cables are essential as the cables are often the most vulnerable part of a system.
- b. Assemble the instrument and power up.
- c. With the instrument held in a static position, and collecting data, move cables to test for shorts and broken wires or pins. Shake cable starting on one end and proceeding to the other. An assistant is helpful to observe any changes in instrument response. If shorts are found, mark cable, set aside and replace.
- d. Conduct Static Test, and Instrument Response Test:
  - (1) Establish an area for these tests that offers convenient access, is free of metal (surface and sub-surface), and is sufficiently far from roads and power lines, transmitters, etc. to avoid these sources of noise. This same point should be used throughout the duration of the project for the daily static and response tests and for instrument nulling.
  - (2) Static Test: The purpose of performing a static test is to determine whether a particular geophysical instrument is collecting stable readings. Improper instrument function, the presence of local sources of ambient noise (such as EM transmissions



from high-voltage electric lines), and instability in the earth's magnetic field (as during a magnetic storm) are all potential causes of inconsistent, non-repeatable readings. The operator must review the readings to confirm their stability prior to continuing with the geophysical survey.

- (a) When the instrument has been powered up sufficiently long to warm the electronics (2 to 5 minutes), place the instrument at its normal operating height and orientation so that it will remain stationary and begin data collection. (An alternative to waiting for the instrument to warm up is to begin data collection when the instrument is turned on, thus documenting the time required for readings to stabilize.) Collect readings for a minimum of three minutes after instrument warm-up. Data collected during static tests should be retained for documentation purposes. This site should also be used to "NULL" and "calibrate" the EM61-MK2; refer to the operating manual for a detailed explanation of this procedure.
  - (b) The effects of ambient noise may vary across a project site. Therefore, it may be necessary to perform several static tests across the survey area.
- (3) The Instrument Response Test using QC coil as per description in section A2 of this manual quantifies the response of the instrument to a standard test item. A steel trailer ball can also be used as a test item that is easily acquired and transported. A standard 2" diameter trailer ball with integrated shaft could be used as the test item. Leaving the instrument in the same position as used in the Static Test, activate the QC coil or place the test item below the sensor, and then collect data for a minimum three minute period. The test will document the amplitude of response to the test item and instrument drift.

## **E.2 Initial Geophysical Instrument Checks**

These tests are performed the first day of a geophysical investigation.

- a. Six-Line Test: This test can be used for all geophysical instruments, and is illustrated in Figure 5.1.

- (1) Use an area that has little background noise and no sources of anomalous responses.
- (2) The test lines should be well marked to facilitate data collection over the exact same lines each time the test is performed. Background response over the test area is established in Lines 1 and 2.
- (3) A standard test item, such as a steel trailer hitch ball (or any metallic object) will be used for Lines 3 through 6. Heading effects, repeatability of response amplitude, positional accuracy, and latency are evaluated in Lines 3-6.

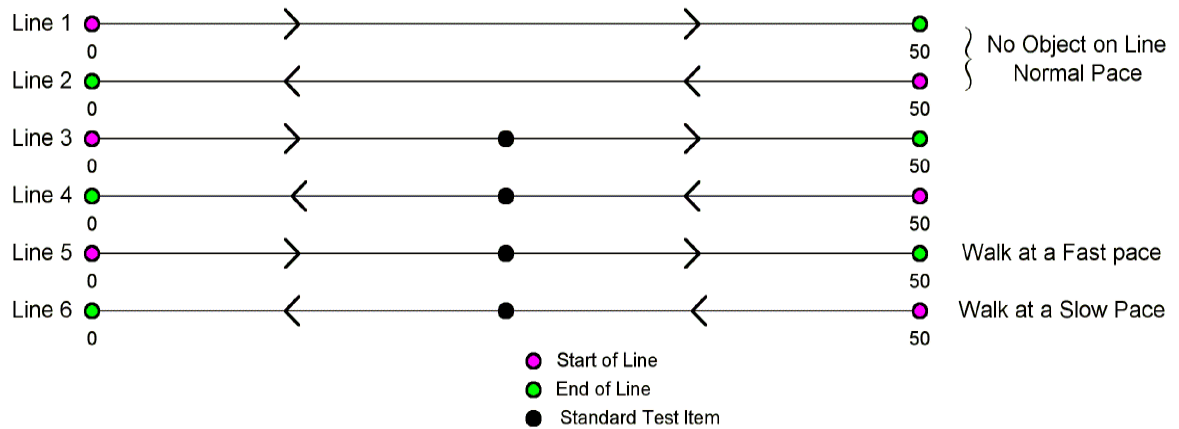

**Figure E.1 Example Test Site**

- b. Pull-Away Test: This test demonstrates the effects of navigational equipment and/or vehicles used to tow sensors or arrays. With the instrument collecting data in a static (background) test, navigational equipment and/or vehicles, positioned as they would be in the field survey, are pulled slowly away from the sensor to gauge any differences in response. This must be performed twice; once with the navigational equipment (and/or vehicle) power off, the second with the equipment powered up. A simple DC shift may be observed when the equipment is in normal operating position, compared to values when it is distant, however this is easily removed from the data. However, a DC shift greater than 50 mVolts should not be considered insignificant and will affect the

instruments sensitivity. If excessive noise (or shift) is noted, however, steps should be taken to identify the source and correct the problem.

**E.3 Suggested Daily Instrument Checks.**

- a. Cable Shake Test: Prior to collecting data each day, the instrument cables and connectors should be tested for shorts as described in the out of box equipment tests. Faulty cables or connectors will be replaced prior to data collection.
- b. Static Test (Background): This test should be performed twice daily in the same location, prior to data collection, and at the end of the day. Data should be recorded during a minimum 3-minute duration static test to demonstrate stability of readings over both the short and long term.
- c. Static Test (Response): Following the static background test, a QC coil or standard test item should be used, and readings recorded for at least 3 minutes. Instrument response of equal amplitude from test to test demonstrates that the calibration of the instrument has not changed. (This test should be repeated when changing batteries.)
- d. Personnel Test: The instrument operator moves around the stationary, operating instrument to scan for any effects from remaining metal on the operator.

**E.4 Examination of Repeat Data.**

A minimum of 5% repeat data is recommended for grid sampling. Repeat lines should be adjacent to one another. A site with a low density of anomalous responses would benefit from a higher percentage of repeat data. When viewed in profile and compared to original data, repeat data provides a means of evaluating the ability of the instrument to respond consistently, and evaluates the positional accuracy of the data. Errors in positional repeatability indicate a problem in the method of navigation.

Test	Frequency of Testing		
	Beginning of Day	Beginning and End of Day	First Day of Project Only
Personnel Test	X		
Cable Shake	X		

Static (Background)		X	
Static (Response)		X	
6 Line Test			X

**Table E.1 Instrument Test Table**

## F Data Acquisition

### F.1 Survey Design Elements.

- a. Line spacing requirements for grid sampling are dependent on the specific geophysical instrument being used and the types of buried targets expected. Geophysical investigations for the more common munitions types (mortars, grenades, projectiles, etc.) that are buried randomly require standardized intervals between lines. The following line spacing has been mandated by some United States military organizations and is recommended for munition site surveys.

<u>Instrument</u>	<u>Line Spacing</u>	
	<u>English</u>	<u>Metric</u>
EM61 (meter wide footprint)	2.5 ft	0.75 m
EM61/ EM61-MK2 (half meter wide footprint)	1.5 ft	0.5 m
EM61-HH	1 ft	0.3 m

**Table F.1 Line Spacing Recommendations**

*For other instruments, alternate line separations may be necessary.*

In cases where small, shallow depth munitions with low amplitude responses are being investigated, it may be necessary to reduce line spacing to one-half the diameter of the receiving coil. Such reductions in line separations will have an adverse affect on production rates. When the objective is to find large, deeply penetrating items or burials (caches, pits, and trenches) line spacing can be increased to suit the situation.

Adequate data density is determined by the same factors as adequate line spacing. However, increasing data density along survey lines usually does not significantly increase survey time or cost. Increased data density improves the likelihood of a reading being taken directly over the peak of an anomaly. The following are minimum data densities for the EM61, EM61-MK2 and the EM61-HH. When operating in automatic sampling mode, the consultant must determine the appropriate sampling rate and operator speed in order to achieve these intervals. As with line spacing, if the objective is to find large, deeply penetrating buried munitions items or burial features, data density may be decreased to suit the situation.

<u>Instrument</u>	<u>Data Density</u>	
	<u>English</u>	<u>Metric</u>
EM61 (meter wide footprint)	0.66 ft	0.20 m
EM61/EM61-MK2 (half meter wide footprint)	0.66 ft	0.20 m
EM61-HH	0.33 ft	0.10 m

**Table F.2 Station Spacing Recommendations**

- b. Meandering Path and Transects: These types of surveys are alternatives to grid sampling that may offer advantages in some investigations. Line spacing for a Meandering Path survey is influenced by vegetation density, as denser areas are avoided. Transects use a fixed spacing between lines. When used in this manner transects may be considered as very narrow grids. Data density in both types should meet the requirements listed above. Unlike standard grid sampling, all of the data in Meandering Path and Transect surveys is subject to edge effects. Passing close to or over the edge of an ordnance item reduces the amplitude of the response compared with traveling directly over it. As a result, different thresholds must be considered for selection of anomalies in these types of surveys. Another important difference versus grid sampling is that the collection of repeat data may not be possible.
- c. File Naming Conventions: A standardized format for file names should be used throughout the duration of a project, and should also be documented. A logical format, incorporating information such as Date, Area, Sector, and Grid # is suggested. For standardized tests that are recommended to be repeated twice daily, such as Static Background, the file name should include the date, the type of test, and an indication of whether it is AM or PM. Note: the Polycorder provided with the standard EM61 limits the number of characters for a file name to 7. The field PC provided with the EM61-MK2 defaults to a date: time file name that can be edited to include the suggested parameters.

## F.2 Operating Procedures for EM61 and EM61-MK2

- a. All EM61s have been designed to keep the operator far enough away from the coils so that small amounts of personal metal will not influence the data. Regardless, pockets should be emptied of coins, knives, etc., and wristwatches removed. Small amounts of metal such as wire-rimmed glasses, earrings, etc. are not detectable by the instrument, and are distant enough in normal use that they cannot cause problems. Steel-toed boots can have a profound impact on data. Steel shanks commonly found in boots are less problematic than steel toes, but should be avoided as the feet may closely approach the coils during data collection. The high sensitivity of the EM61 Hand-Held coils increases the likelihood that metal components in footwear may compromise data quality. Carefully inspect the operator for metal. Removing metal from the operator is most critical when operating the EM61 in harness mode because the operator is inside the coils.
  
- b. The operating manuals of most geophysical instruments do not include a discussion of a warm-up period prior to collecting data. However, all geophysical instruments undergo a short period of reading drift as the system electronics warm-up. Instruments should be allowed to warm-up a minimum of 5-15 minutes every time they are turned on or the battery is changed. Low ambient temperatures will demand a longer warm-up period. The geophysical team will carefully examine the readings to ensure that they have stabilized.
  - (1) Figure 6.1 illustrates drift typically seen in the warm-up period for an EM61.

Performing a static test will quantify this warm-up reading drift and at the same time satisfy the need to document ambient noise at the site. The static test shown in Figure 6.1 exhibits very low background noise. In this example, a standard EM61 was operated in Auto Mode (extra fast), collecting approximately 8 readings / second. The ambient temperature was approximately 70 degrees F. The instrument electronics warmed up and produced stable readings in less than three minutes.

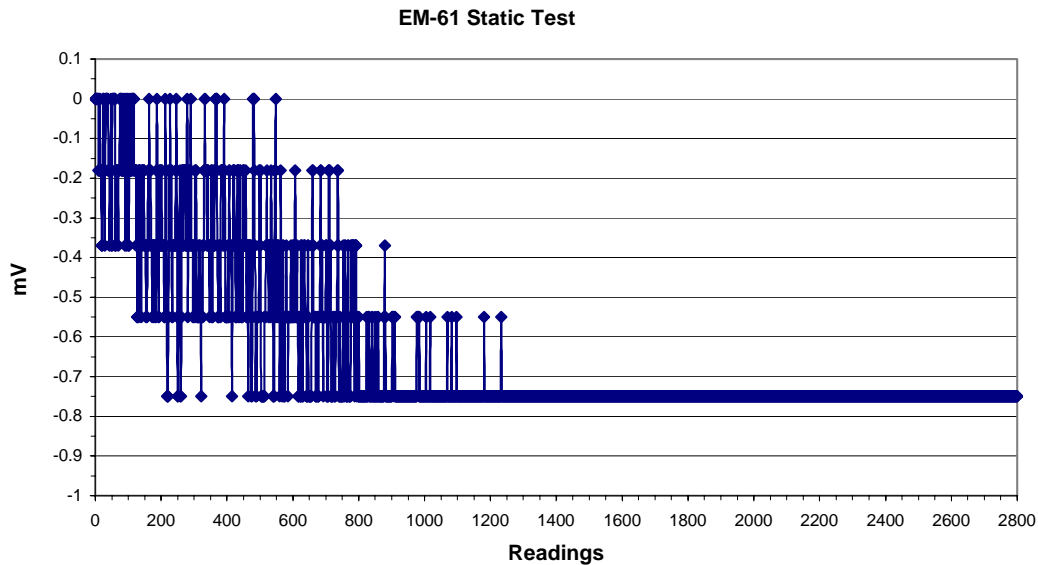

**Figure F.1 Instrument Warm Up**

- c. Check battery levels and record in field notebook or grid survey form before and after data collection. EM61 batteries should be replaced when the voltage falls to 10.5 volts.
- d. The rates of data acquisition for EM61's are limited by the processing speed of the data logging system. A minimum amount of time is required for the system to process and record each reading. If a second reading is triggered before the first is recorded, the data logger (polycorder) will 'beep' and the first reading will be dropped. This results in an incomplete data set.
  - (1) Using the standard EM61 or EM61 Hand-Held in Wheel or Hip Chain mode, the options of Full, Partial, or No Display are available at the start of each file. The Full option will display data after conversion to millivolts and allows the collection of 4 readings per second. The Partial setting displays data as unconverted raw voltage, allowing a collection rate of 8 readings per second. No Display shows only the present station coordinates, resulting in available collection rates of 8 readings per second.
  - (2) When starting a new file, a standard EM61 or EM61 Hand-Held in Auto Mode offers the options of User Defined / Fast /Extra Fast data collection rates. The User Defined option is capable of recording up to 4 readings/second. The Fast option records 5 readings/second without GPS and 4 readings/second with a GPS time

stamp. The Extra Fast mode collects 8 readings/second without GPS and 7 readings/second with a GPS time stamp.

- (3) The EM61 MK2 uses a more sophisticated Juniper Systems Pro 4000 or Allegro field PC. The maximum data acquisition rate increases to 19 records/second, with each record consisting of four sampled time gates per station and, optionally, position data.
- e. Older EM61 wheels contain a limited amount of metal that is distributed unevenly within the rim of the wheel. As a result, these wheels can cause periodic anomalous responses of several millivolts or more as measured by the bottom coil. With a low enough target selection threshold, the wheel responses may be incorrectly interpreted as being representative of subsurface metal.
- (1) Alternatives to using the older hard rubber EM61 wheels include substituting either EM61 Handheld wheels or the most recent standard EM61-MK2 wheels which have solid foam tires. Both types of wheels are free of any metal components and can be easily mounted on the EM61 axles.
  - (2) In addition to metal components in the wheels themselves, wheel noise can be introduced by nails or metal fragments embedded in the tires. This may also cause periodic anomalous responses as the object rotates past the coils. EM61-MK2 wheels will be carefully inspected throughout the data collection process in order to minimize this problem.
  - (3) Should wheel noise be suspected during the project, the following test can be performed. Invert the EM61-MK2 and conduct a static test for one minute followed by collecting one minute of data while slowly spinning each wheel. Any additional noise present in the portion of the file collected while a wheel was spinning is likely due to the presence of metal somewhere in that wheel.
- f. Loose, dangling cables could potentially cause anomalous responses in EM61-MK2 data. The cable connecting the coils to the backpack should be temporarily attached to the handle (with tape, Velcro straps, etc.) in order to eliminate the cable as a source of geophysical noise.



- g. At the start of every project, the geophysical consultant will establish a nulling and calibration station where the top and bottom coils can be leveled. The nulling station must be established in an area free of metal, with no interference from sources of ambient noise. Mark the center of the nulling station with a semi-permanent, non-metallic marker, to ensure consistent placement of the instrument each day. The station should be placed in the same spot as the static test station and will also be occupied at the beginning and end of each work day. Early model EM61s have no means for nulling or calibration, therefore data must be leveled during post-processing.
- h. If GPS is to be used and logged to a separate recorder from that of the EM data, synchronization of the internal clocks is critical for accurate location of data. Once the clocks are synchronized, data collection may begin. It is recommended that you open a test/calibration data file in both data loggers and attempt to begin taking actual measurements at exactly the same time. It is recommended that this be completed at the start and end of each day as the clock in some DL600s is known to drift. (<1sec/24hours). This will get you to sub-second accuracy depending on how fast your fingers are. Additionally a known calibration "site" where a known EM target exists (such as a 6" spike driven into the ground) should be established. Locate the station accurately with the DPGS, and then collect data across the target a number of times in the same fashion, as you would be conducting your survey. It then becomes a simple spreadsheet task to match the peak instrument response and time with the DPGS known target location. This information is then used in the DAT61W program.
- i. During data acquisition, the operator will pay close attention to sounds emitted by EM61/MK2 backpack and the data logger to evaluate instrument function and data quality. Continuous, audible response may be indicative of metal stuck to the instrument or the effect of a low battery. No audible response over visible metal objects may indicate another sort of instrument malfunction.
- j. The operator should note the presence of all sources of potential EM interference (objects that will affect the instruments response). These comments should be noted digitally on the instruments datalogger. The EM61/EM61-MK2 data acquisition systems allow for comments to be embedded in the data; thereby the correct position of the

surface metal (or other source of interference) can be noted on the interpretation diagrams.

## **G Navigation**

### **G.1 Introduction.**

Prior to the advent of GPS and other electronic navigation systems, geophysical data was collected and positioned using local coordinate systems. In recent years, GPS in particular has become an increasingly popular tool for geophysical surveys at buried munitions sites. The latest systems are capable of providing, under the right circumstances, positional accuracy measured in centimeters. Despite this, the use of local grids and conventional methods is still preferred in many circumstances, as it provides a high degree of accuracy at low cost, regardless of obstructions such as overhead tree canopy.

### **G.2 Conventional Navigation**

These methods involve placing temporary markers on the ground surface in order to establish data collection lines. In a typical grid layout, the markers allow the operator to traverse the grid using straight, parallel lines and ensure that the entire area has been covered.

- a. Grid set-up begins with the establishment of line separation and length in the required units (meters or feet). If squared grid corner stakes are already in place, tape measures can be pulled between them on all sides. Tape measures and/or surveying equipment (transit, compass, etc.) can be used to establish right angles if no grid stakes are present.
- b. Fiducial marks (known locations entered into the data during collection) will be placed on the ground using temporary markers. Temporary markers commonly used for fiducial locations include measuring tapes, marking paint and ropes. The distance between fiducial marks is dictated by site conditions; less visibility due to rolling terrain or dense vegetation will require closer spacing.
- c. Using conventional navigation methods, it is essential that straight-line profiling be maintained. The operator must have easily visible monuments along which to walk. Fiducial ropes with paint marks at every line location will accomplish this. Another commonly used method is to place traffic cones at the start, end and at intervals along

each line. The use of cones requires the operator or other team members to move them as data collection proceeds.

### **G.3 Global Positioning System (GPS)**

This method of navigation has increased in popularity in recent years, as the accuracy of the positions has increased. Software for most Geonics systems now includes a means of integrating GPS positions with geophysical data.

- a. Standards for Equipment: GPS equipment varies drastically in price and quality, therefore the consultant should determine a minimum standard for equipment to be used in Digital Geophysical Mapping (DGM) surveys.

- (1) Small hand-held units manufactured for recreational use are not usually acceptable for DGM work. These units typically cost \$150 to \$400, and while helpful for finding general locations, are not capable of the level of precision necessary for geophysical surveying. These types of GPS units can achieve accuracies of approximately 30 meters. WAAS enabled systems claim accuracies of 3 metres – but with generally no mention of acquisition time required to achieve these accuracies.

- (2) The use of Differential GPS (DGPS) allows for the correction of errors in positioning from several sources, which include clock errors, atmospheric effects, and signal reflections. Accuracies within a meter or two are possible using DGPS, given favorable conditions. Differential GPS making use of the Carrier Phase permits accuracies within centimeters. Correction of bias factors may be accomplished in real time, using a Real Time Kinematic (RTK) GPS system, or through Post Processing. RTK systems utilize a base station, set up on a known point, which then transmits corrections to a roving GPS unit via radio. Post Processing techniques also rely on base stations, which can be set up on site, or can be a remote station. Base station data is used to apply a correction vector to the rover data. The level of accuracy required for a specific project depends on the goals.

- b. Minimum Standards for Data Quality: The number and location of satellites visible to the antenna, and the presence of obstructions influence the level of accuracy for a GPS reading.

- (1) A factor called DOP (dilution of precision) is a measure of the level of precision that can be expected for a particular arrangement of satellites. The DOP is computed from a number of other factors, including: HDOP (horizontal), VDOP (vertical), TDOP (time). Together these factors are used to compute the PDOP (position dilution of precision). Although PDOP is commonly used, HDOP may be more applicable to DGM work, in which the x,y coordinates are used to map anomalies. GPS accuracy in the vertical dimension is less than in the horizontal. Most GPS receivers can be programmed to output the HDOP or PDOP, which is reported as a number between 1 and 9. For HDOP, a value of 1 is ideal, 2 is considered excellent, 3 to 5 good, 6 to 8 fair, and 9 poor.
- (2) Although PDOP (or HDOP) gives some indication of data quality, probably the most important indicator of data quality is the number of satellites used for determining position. It is possible to have a low PDOP and still have significant errors in positioning, especially with few satellites. A minimum of four satellites is needed to determine position; however accuracy increases with additional satellites.
- c. Time Synchronization: GPS satellites use atomic clocks capable of extremely accurate time keeping. Geophysical instruments use somewhat less sophisticated clocks, which may drift in relation to the GPS clocks. When recording geophysical data in a separate device from the GPS data, the recorded times are used to later position the readings. It is crucial that the times be synchronized to permit accurate location of the data. Prior to collecting data, the times must be synchronized between the two devices as accurately as possible. When finishing a grid, transect, etc, check the synchronization of the data recorders again, and record any difference noted. The difference will be used to apply a correction to the data.
- d. Quality Control: A point will be established on the site where GPS readings will be collected twice daily (AM and PM), for comparison of the computed position. This point will be located in a convenient area, such as the nulling station.
- e. Planning Software: Software is available from the major manufacturers of GPS equipment for planning surveys ahead of time. The orbits of the satellites, and the time they will pass over a specific area is included in GPS almanacs, which are downloaded from the satellites by the GPS receiver or may be downloaded from the Internet. The

planning software uses this information to determine the number of satellites and predicted PDOP for a given location and date. At certain times of day, the number of satellites visible to the receiver may be inadequate to provide high quality data. Another possibility is that the constellation geometry may be such that a high PDOP results. In either case, knowledge of this period ahead of time will prevent the consultant from attempting to collect data with poor precision. Work / Rest periods must be planned to avoid data collection in times of poor satellite geometry or few visible satellites.

## **H Data Storage and Transfer**

### **H.1 Recommended Field Storage and Transfer Procedures.**

- a. Instrument data should be dumped from the Polycorder, PRO4000 or Allegro to a field computer immediately following completion of a survey grid. If the data logger does not have sufficient memory to complete an entire grid, it will be dumped as needed. Immediate dumping lowers the risk of any data being lost as well as allowing the consultant to make initial assessments regarding data quality and methodology.
- b. The field geophysical team should fill out an appropriate Daily Log each day.

## **I Data Processing and Analysis**

### **I.1 Introduction**

This section outlines basic data processing procedures for geophysical data collected for buried munitions surveys. Systematic and proven methods are important to maintain consistent quality of data and to allow for an evaluation of data quality. Identifying and reducing the causes of below standard data is simplified by following a basic established method.

Qualified personnel for data collection and data processing are the most important factors in producing quality data. Data collection personnel should be trained and familiar with the instruments and their operation. Data processing personnel must have an understanding of the geophysical principles and the nature of the data in order to properly evaluate the sensor response. A qualified geophysicist must be able to identify and correct for noise factors and be able to distinguish signals above the noise level. Inexperienced personnel may result in a reduction of the quality or incorrect interpretation of data. The main stages of geophysical data

processing and analysis for buried munitions are field editing, preprocessing, processing and target selection, advanced processing, and the preparation of deliverables.

## **I.2 Field Editing Data**

These steps are performed prior to leaving the site by the field geophysicist or a data processor on site.

- a. The software supplied with most Geonics instruments allows the editing of many of the common errors made during data acquisition. A member of the geophysical team, preferably the operator who collected the data, will evaluate the completed file for correctness of line numbers, starting and ending points, and line direction. Fiducial corrections will then be applied to the data. All editing and corrections will then be saved using a new file name.
- b. Each line's response amplitude will be examined in profile for overall quality. Particular attention will be paid to geophysical noise levels to ensure that they fall within acceptable thresholds. Acceptable noise levels vary from site to site and should be agreed upon based on the collected data.
- c. Once the data file has been edited and checked for quality, it must be converted to a xyz file format for contouring and examination. The most common programs used to contour geophysical data, Golden's Surfer and Geosoft's Oasis Montaj, accept xyz files. Such files can also be viewed as Microsoft Excel spreadsheets.
- d. After the data values have been examined and determined to be of expected quality, the positioning of the data must be evaluated. Regardless of whether electronic or conventional navigation methods are used, the process for checking accuracy is the same. Most common contouring programs allow the creation of post maps. These maps show the geographic position of every point collected. The lines and stations should be evenly spaced throughout a grid. Problems in data spacing using conventional navigation methods are usually caused by misplaced fiducial marks or end points and can be easily remedied. Data positioning errors found in electronic navigation can be caused by a variety of problems and are often more difficult to fix.

### I.3 Preprocessing

These corrections are applied to the raw data to improve positioning and remove any other errors introduced by the instrument.

- a. Incorporating navigation information. Positioning geophysical data and conversion to required coordinate system. When positioning data is stored in a separate file from sensor data, e.g. GPS, a common marker such as a time stamp is required in both data sets to correctly position the sensor data. This step should also include the interpolation of positions, if required, and any conversion or projection to a specified coordinate system.
- b. Removal of Instrument Drift and Leveling of Data. Drift correction is needed when the "no response" value of an instrument changes during the course of the survey. This can be caused by temperature variations and may be minimized by allowing the instrument to warm up for a sufficient amount of time before use. Leveling may be performed manually by visual inspection of the data or statistically by calculating the deviation of the data from the mean or "no response" value.
- c. Lag (and Offset) Corrections. Lag effects are visible in gridded data as chevron patterns or wavy edges of anomalies, see Figure 9.1. Lag is caused by a time delay in instrument response and the recorded position. Determining the shift is done by measuring the distance between equivalent points of an anomaly on neighboring lines and dividing this value by two. A negative lag will shift the data forward in time (for the sensor trailing the logger) and a positive lag shifts the data back in time (for a sensor leading the logger).

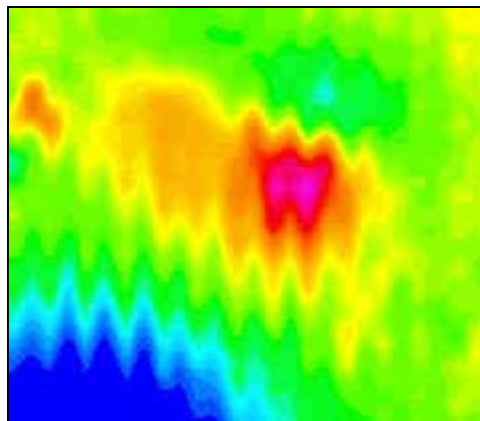

**Figure I.1 Example of Chevron Affect**

## I.4 Processing and Target Selection

This section describes the application of processing routines and filters, analysis of geophysical data and interpretation of gridded or modeled data. When using filters it is important to keep their limitations in mind. Inappropriate usage can result in the removal or corruption of real anomalies, accentuation of noise or ringing, and add errors to the data. An understanding of the effects of filtering is necessary.

- a. Gridding and Contouring. Preprocessed data is gridded and contoured to create a smooth interpolated 3D response plot of the area. Gridding method and parameters should be selected to best preserve the true nature of the collected data.
- b. Digital Filtering and Enhancement. Data is filtered and enhanced to diminish the effects of noise and enhance the anomalous response and subsequent re-gridding if required. The following list describes some of the more common filters used for geophysical data.
  - (1) Linear low pass - removes high frequency, short wavelength features from the data. This filter is effective at removing low amplitude high frequency noise and tends to smooth the signal.
  - (2) Linear high pass - removes low frequency, long wavelength features from the data. The result will be the sharpening of features in the data.
  - (3) Linear band pass - is a combination of a high and a low pass filter allowing only features with wavelengths between a specified long and short wavelength to remain in the data.
  - (4) Non-linear - a de-spiking algorithm is effective at removing short wavelength features with high amplitudes from the signal. Filter tolerances are set for the width and amplitude of spikes to be rejected relative to the local background. Once rejected features are removed they can be replaced by interpolated values based on neighboring readings.
  - (5) Rolling statistics - calculates the statistics within a moving window along a channel of data. This filter will produce a statistical measure of the data within the moving window and outputs the selected statistical value at the center of the window. This



- filter can be used as a measure of the variability of the data or as a means to smooth out the appearance of the data.
- (6) Difference - useful for identifying noise in data. A difference filter calculates the difference between values in a single channel of data; the fourth difference filter is the most common.
  - (7) 3x3 Hanning convolution - this smoothing filter tends to reduce low amplitude, high frequency responses within the data. It also improves the appearance of the gridded data by soothing transitions between contours. The overall effect of the Hanning filter is a reduction in the number of peaks within a grid.
- d. Threshold Selection. Generally a single threshold is set for an entire site. The selection of the threshold value should be based upon two main factors:
- (1) It should be set above the apparent noise level of the data set.
  - (2) It should be set below the expected response amplitude of buried munition items on the site.
- e. Anomaly Selection and Quality Control of Target Picks. A peak-picking algorithm is performed on gridded data to identify anomalies with positive responses above a selected threshold. Any automated target selections must be reviewed by a qualified geophysicist and refined; missed targets should be added and redundant picks removed. If necessary, identify areas or regions that have high ferrous or geologic clutter as it may not be practical to perform discrete target selection within these regions.
- f. Prioritization of selected targets. Targets are usually prioritized by amplitude assigned unique target identifiers for each selected anomaly.

## **I.5 Advanced Processing**

Advanced processing involves further steps beyond target selection to prioritize and discriminate selected targets. The items listed below should be regarded as a brief list of the more established advanced processing topics currently being used and developed. There is considerable research being conducted in the buried munitions discrimination field and although

some new methods are producing positive results it is not possible to include a complete list of all developmental processing techniques.

- a. Depth Estimates. The Geonics depth calculations used in our software are based on a dipolar approximation. These equations are as follows:

$$d = -2229.57 + (7288.13 \cdot R) - (9635.78 \cdot R^2) + (6458.69 \cdot R^3) - (2158.63 \cdot R^4) + (292.118 \cdot R^5)$$

**Equation I.1 Geonics Depth Calculation for 1 x 1 meter system**

*d is in meters*

R is the ratio  $\frac{TopCoil}{BottomCoil}$

$$d = -155.95 + (795.09 \cdot R) - (1715.82 \cdot R^2) + (2026.38 \cdot R^3) - (1413.19 \cdot R^4) + (582.55 \cdot R^5) - (131.581 \cdot R^6) + (12.5886 \cdot R^7)$$

**Equation I.2 Geonics Depth Calculation for 1 x 0.5 meter system**

*d is in meters*

R is the ratio  $\frac{TopCoil}{BottomCoil}$

- b. Analysis of Spatial Anomaly Shape. This is used to distinguish between intact ordnance and clutter.
- c. Multi-channel Analysis, e.g. Time Decay Curve. Developing systems such as the Geonics EM-63 have shown that different ordnance items have unique responses when viewed over multiple time gates. Currently algorithms are being developed to discriminate different ordnance with this instrument.